

Social Care Health & Housing Chart March 12

Social Care Health and Housing

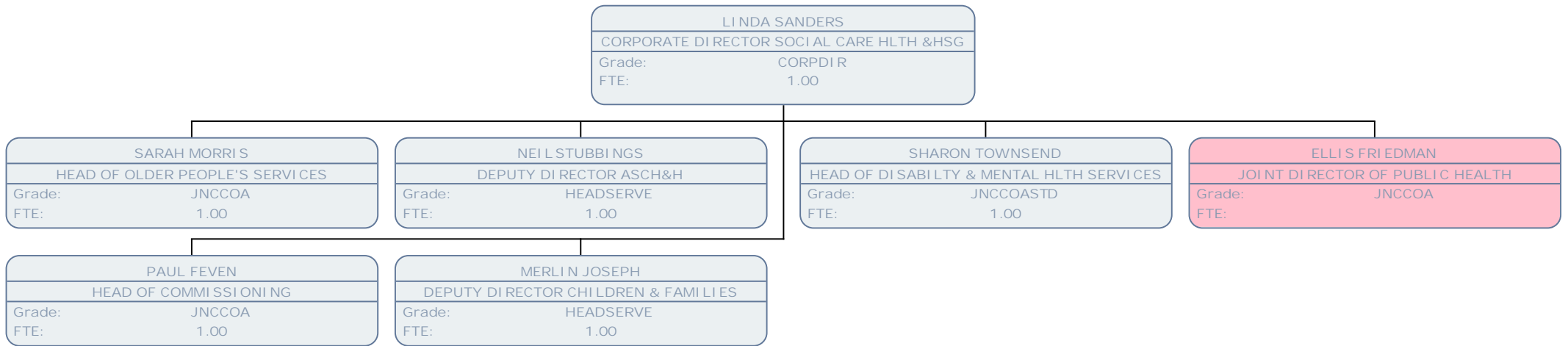

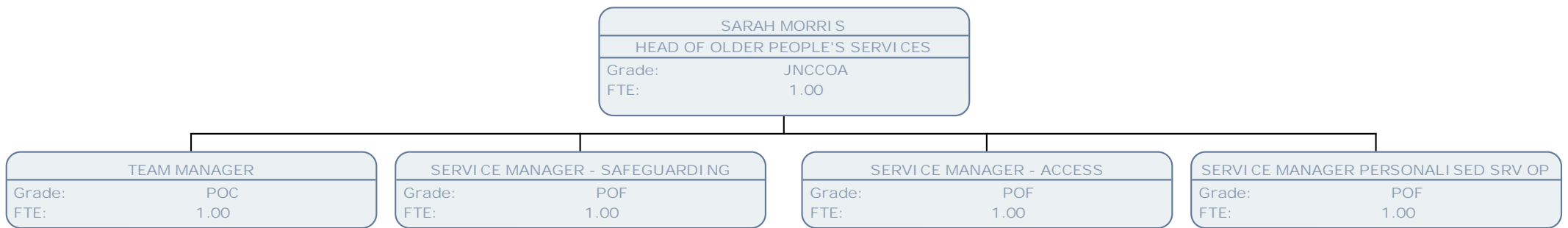

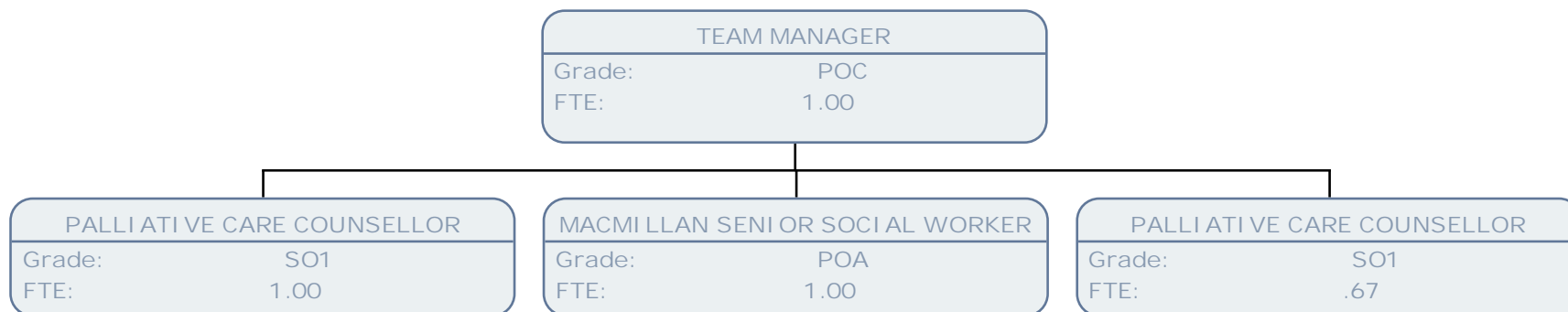

MACMILLAN SENIOR SOCIAL WORKER	
Grade:	POA
FTE:	1.00

MACMILLAN SOCIAL WORK ASSISTANT	
Grade:	SCALE 5
FTE:	.79

MACMILLAN SOCIAL WORK ASSISTANT	
Grade:	SCALE 5
FTE:	.21



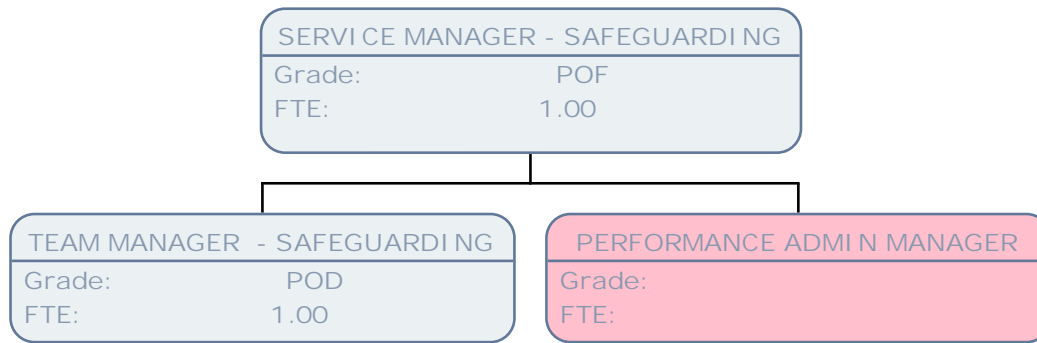

TEAM MANAGER - SAFEGUARDING	
Grade:	POD
FTE:	1.00

DEPUTY TEAM MANAGER	
Grade:	POC
FTE:	1.00

CARE MANAGER SW	
Grade:	SO1
FTE:	1.00

CARE MANAGER SW	
Grade:	POA
FTE:	1.00

CARE MANAGER SW	
Grade:	POA
FTE:	.67

CARE MANAGER SW	
Grade:	POA
FTE:	.83

CARE MANAGER	
Grade:	SO1
FTE:	1.00

CARE MANAGER	
Grade:	SO1
FTE:	1.00



DEPUTY TEAM MANAGER
Grade: POC
FTE: 1.00

CARE MANAGER SW
Grade: SO2
FTE: .67

CARE MANAGER SW
Grade: POA
FTE: 1.00

CARE MANAGER SW
Grade: SO2
FTE: 1.00

CARE MANAGER SW
Grade: POA
FTE: .72

CARE MANAGER SW
Grade: SO2
FTE: .83

CARE MANAGER
Grade: SO1
FTE: 1.00



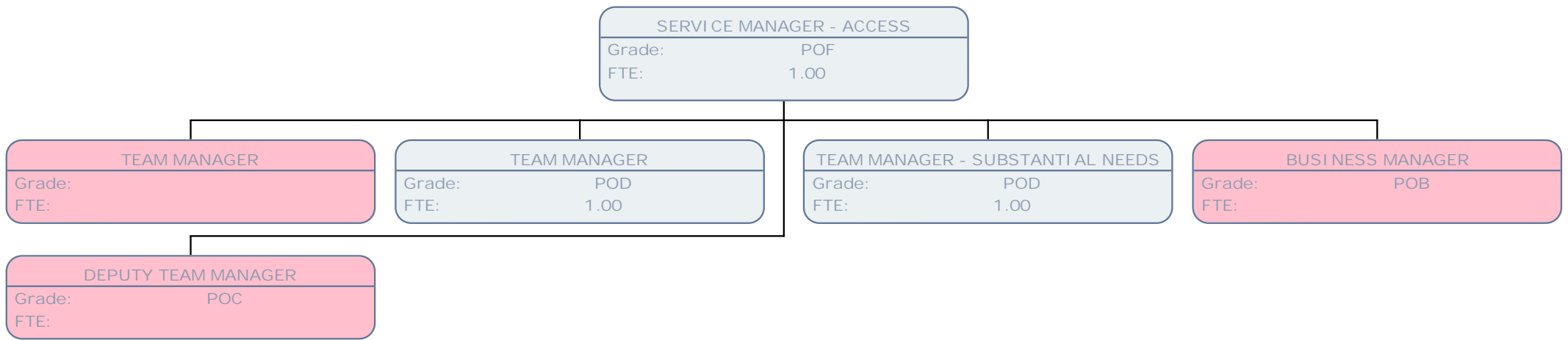

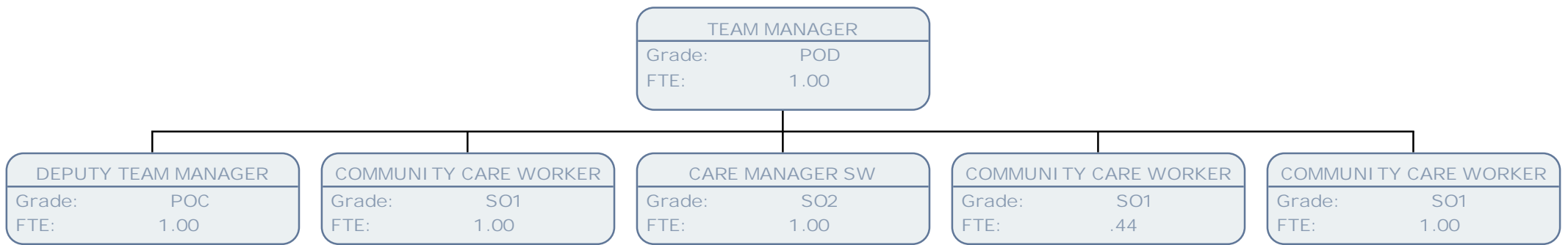

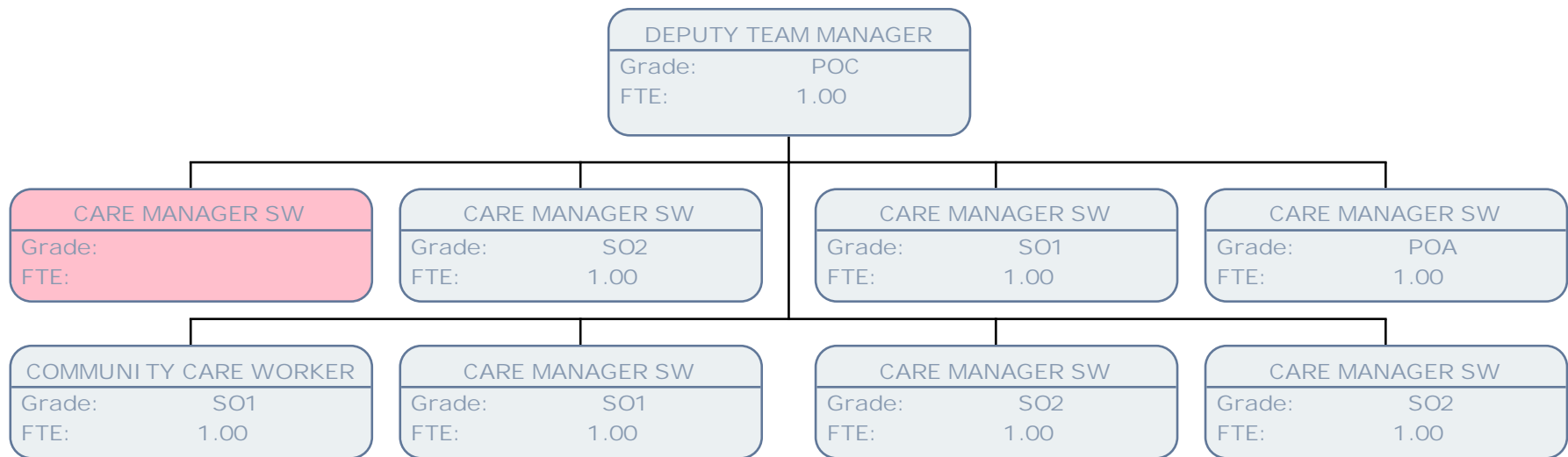

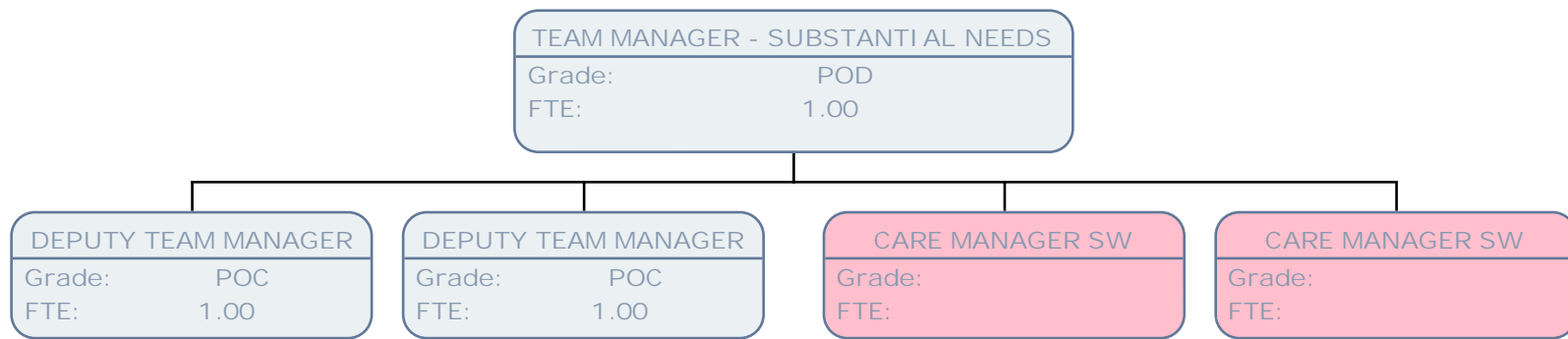

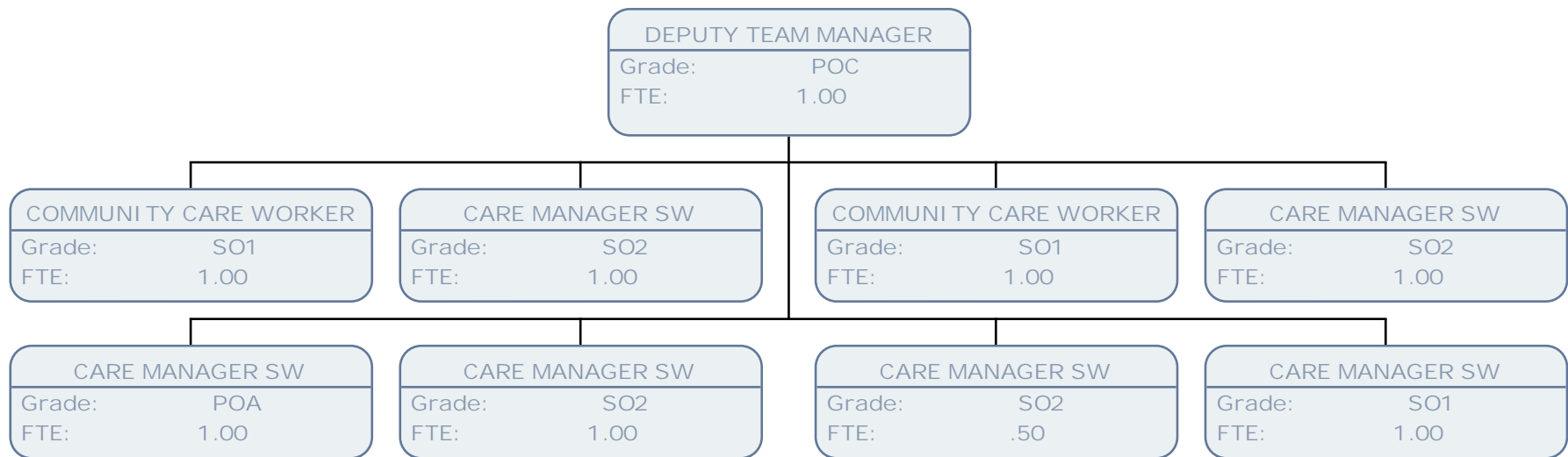

DEPUTY TEAM MANAGER	
Grade:	POC
FTE:	1.00



CARE MANAGER SW	
Grade:	POA
FTE:	.89

COMMUNITY CARE WORKER	
Grade:	SO1
FTE:	.50

CARE MANAGER SW	
Grade:	SO1
FTE:	1.00

CARE MANAGER SW	
Grade:	POA
FTE:	1.00

CARE MANAGER SW	
Grade:	SO2
FTE:	1.00

COMMUNITY CARE WORKER	
Grade:	SO1
FTE:	1.00



BUSINESS MANAGER	
Grade:	POB
FTE:	



PERFORMANCE ADMIN MANAGER	
Grade:	SO2
FTE:	1.00

PERFORMANCE ADMIN MANAGER	
Grade:	SO2
FTE:	1.00



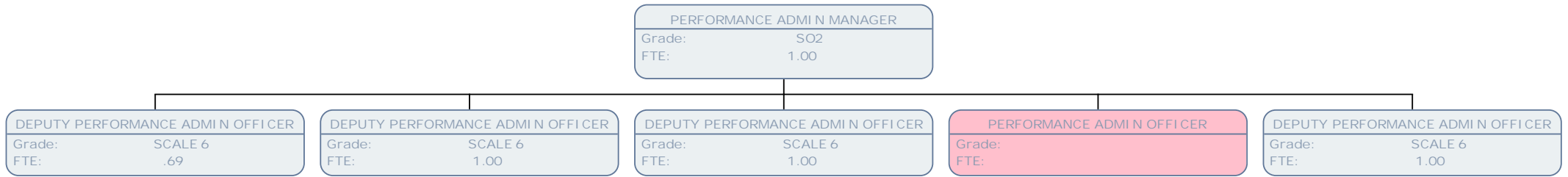

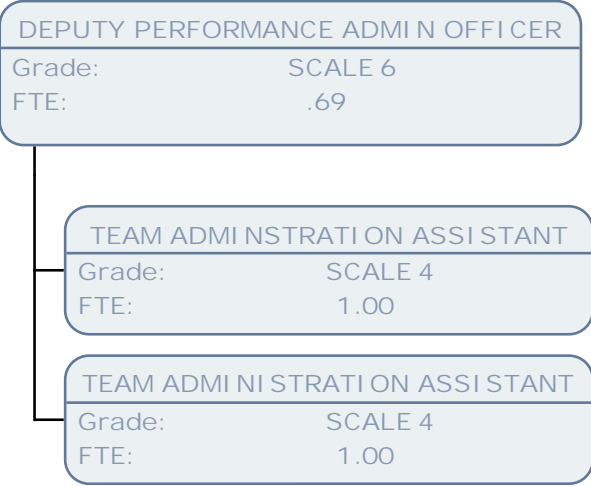

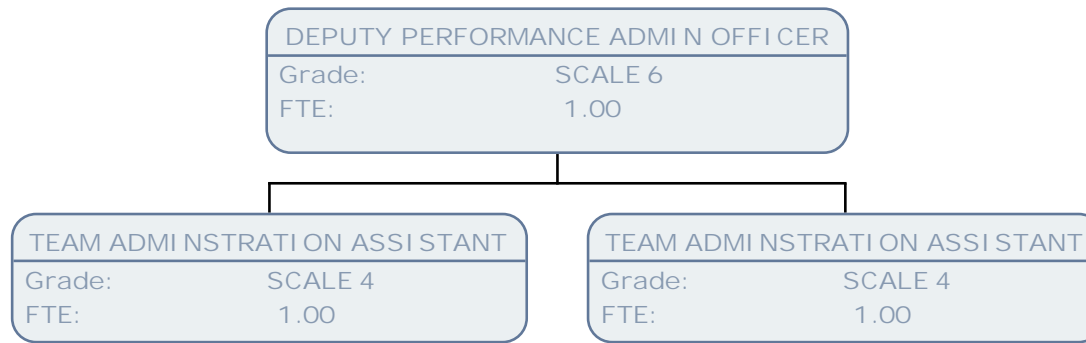

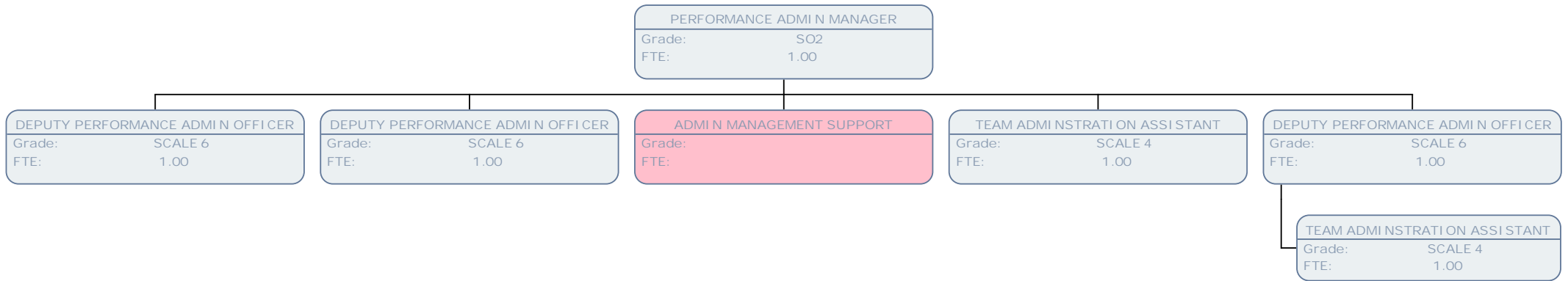

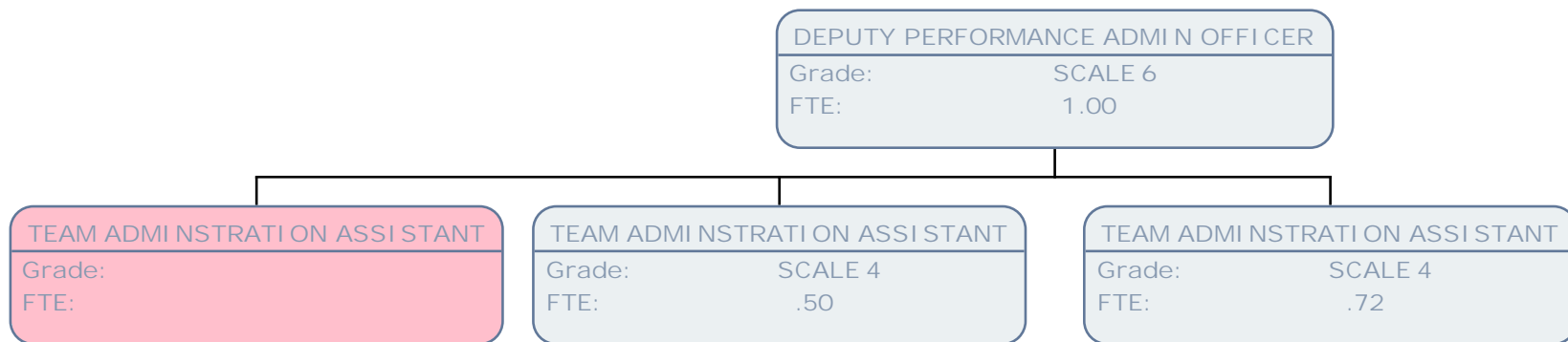

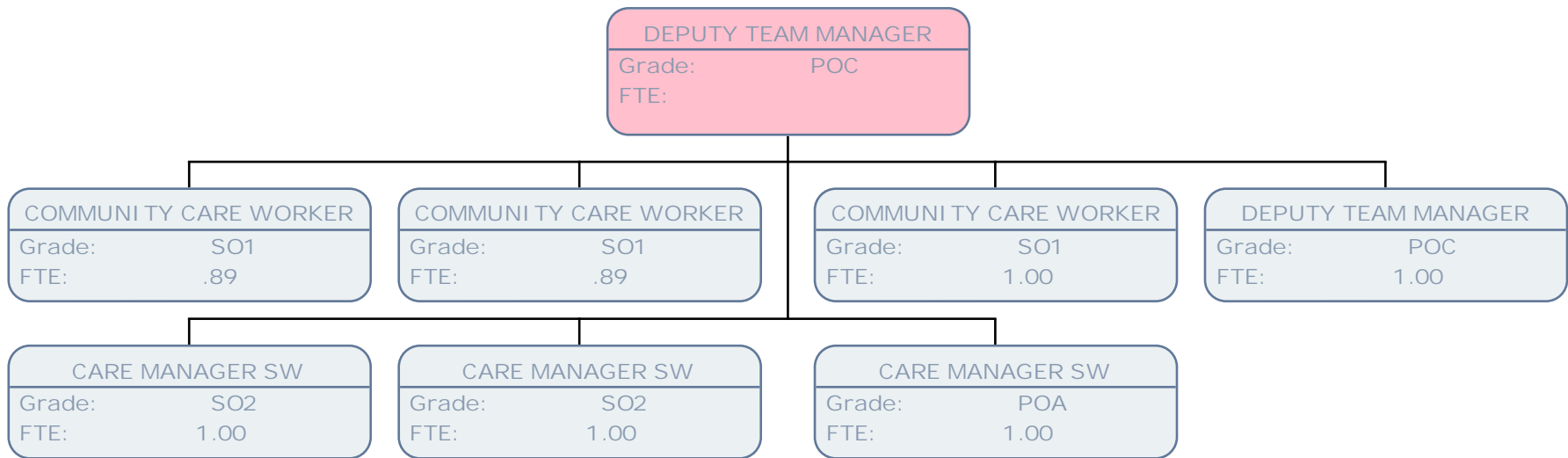

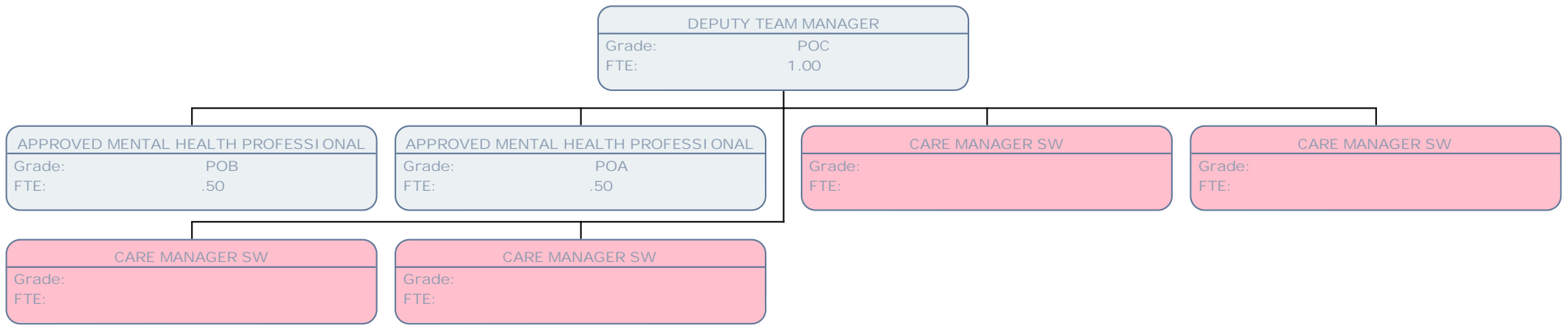

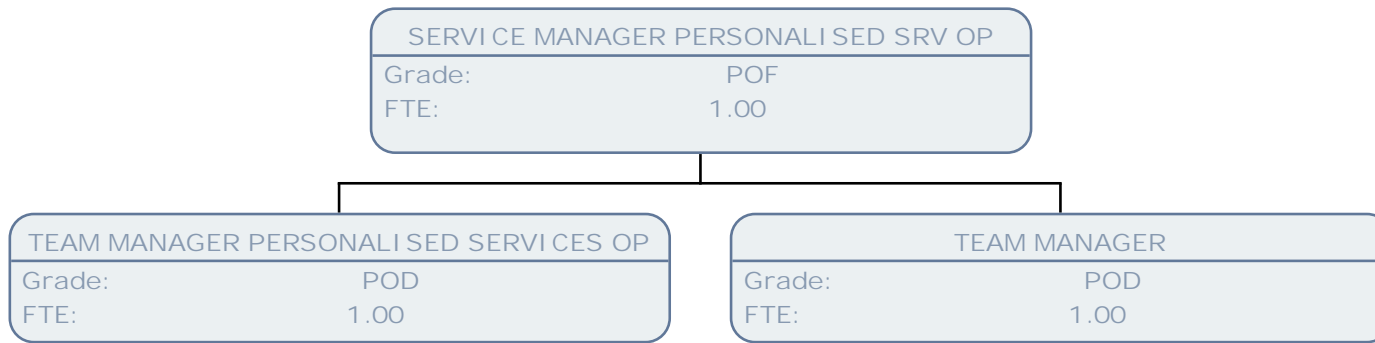

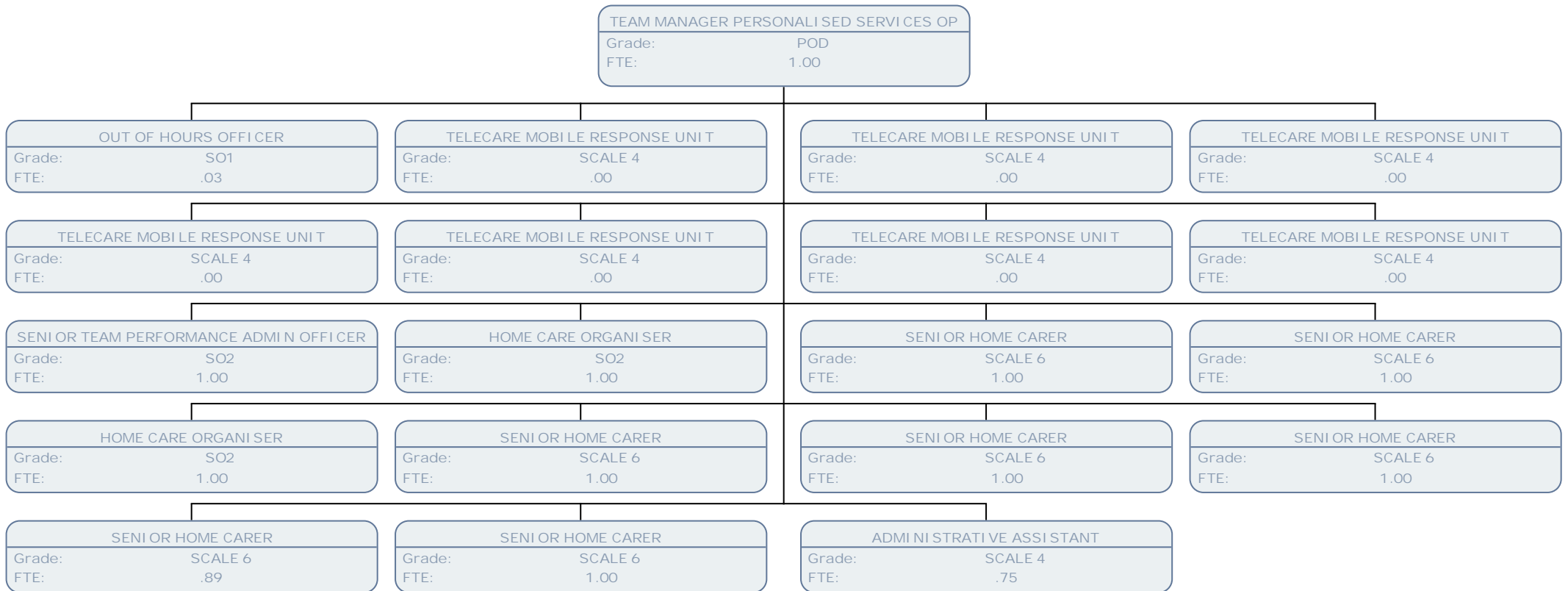

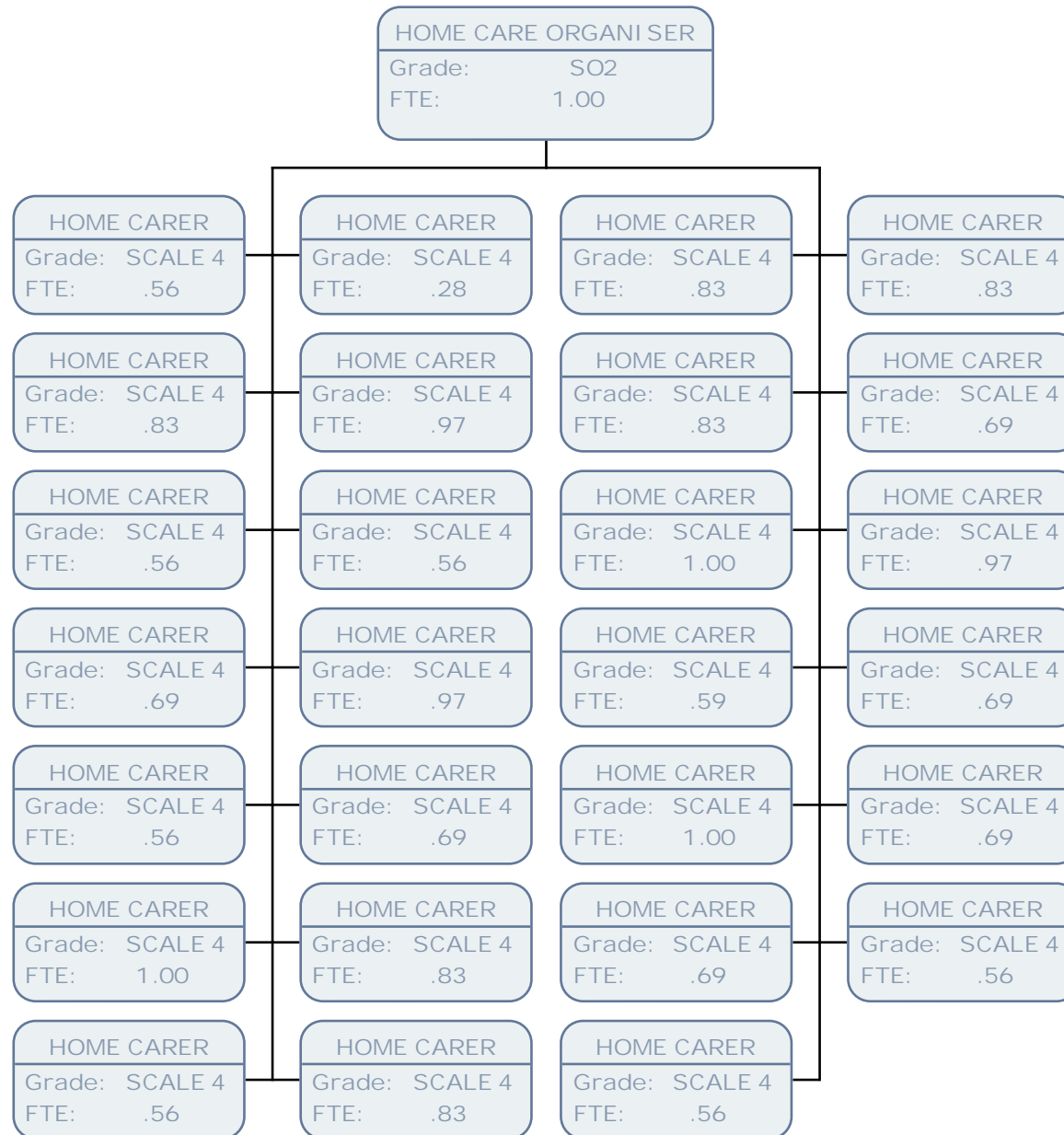



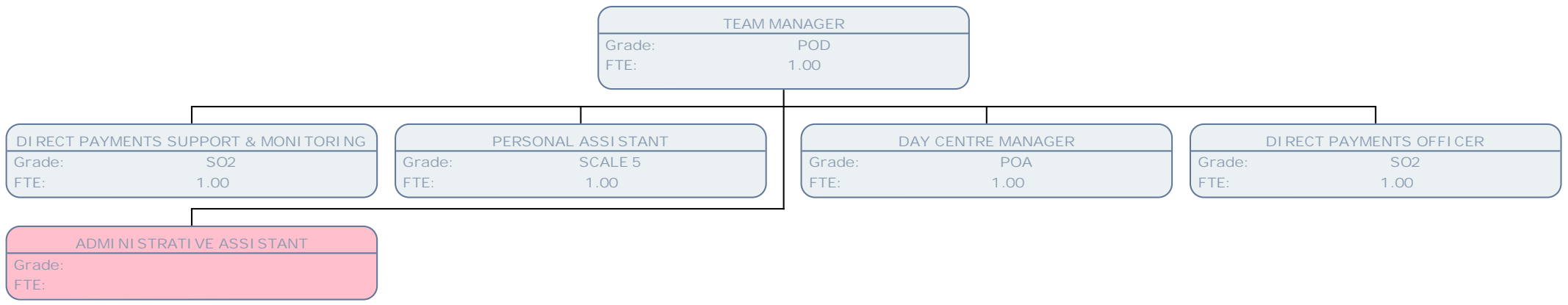

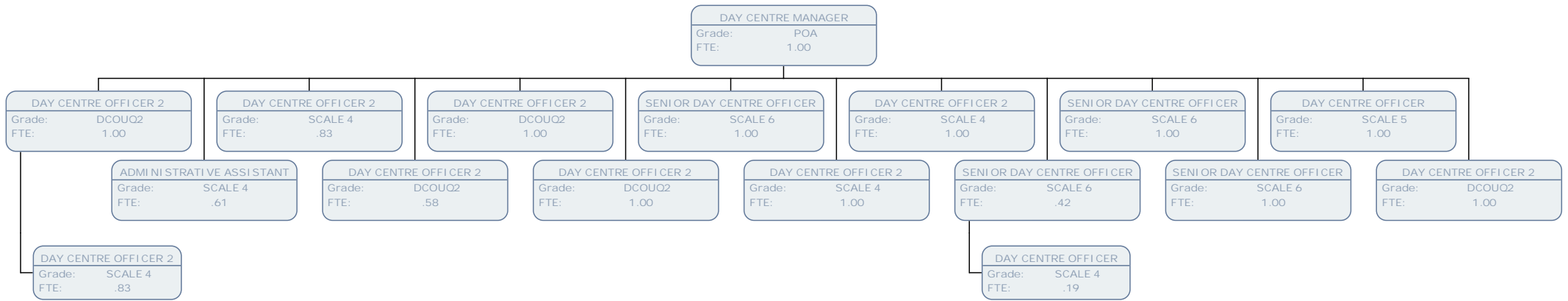

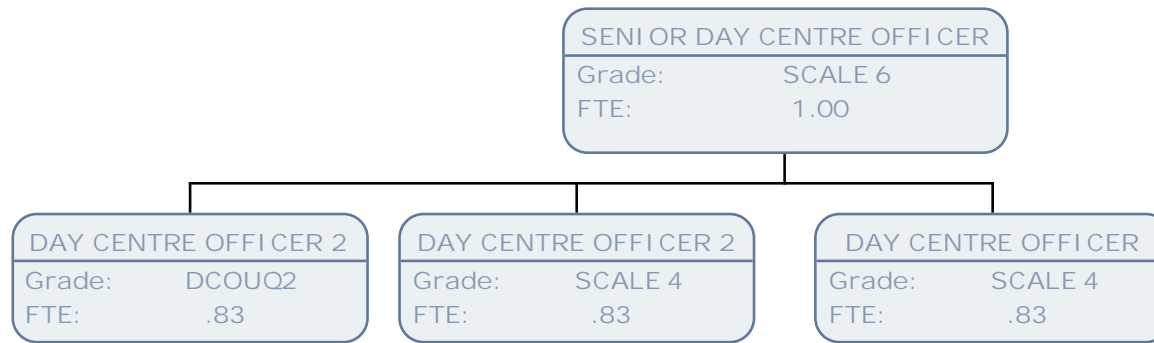

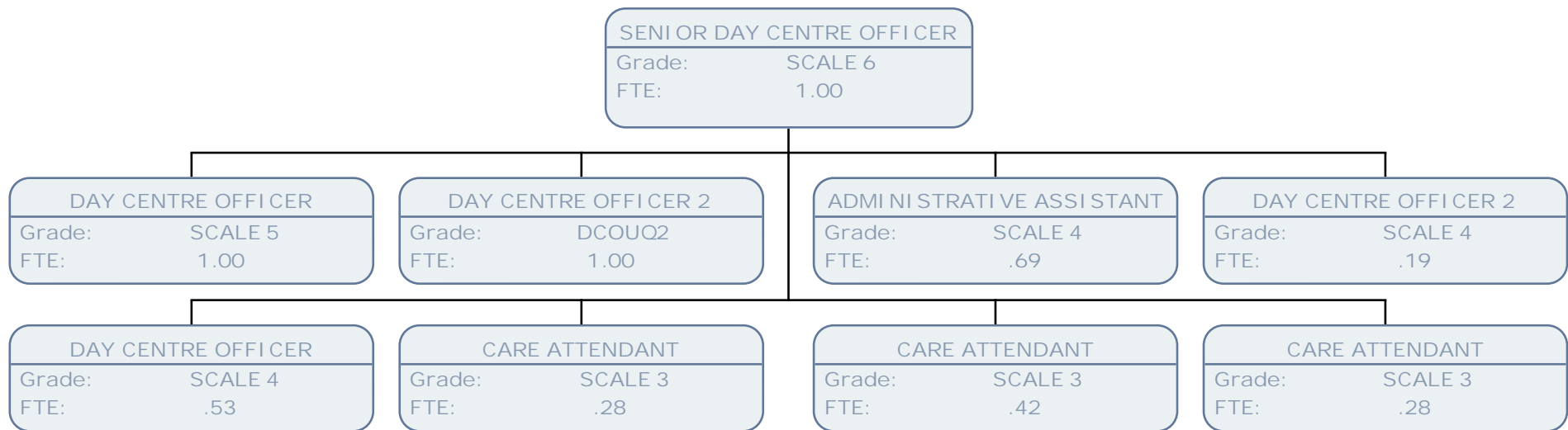

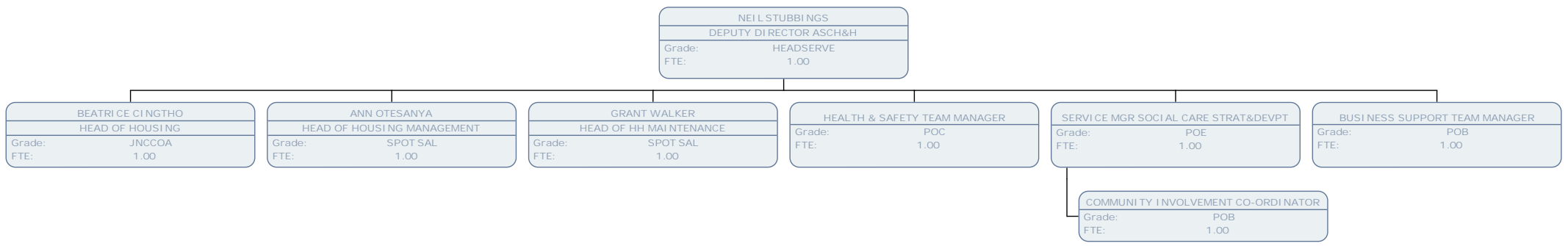

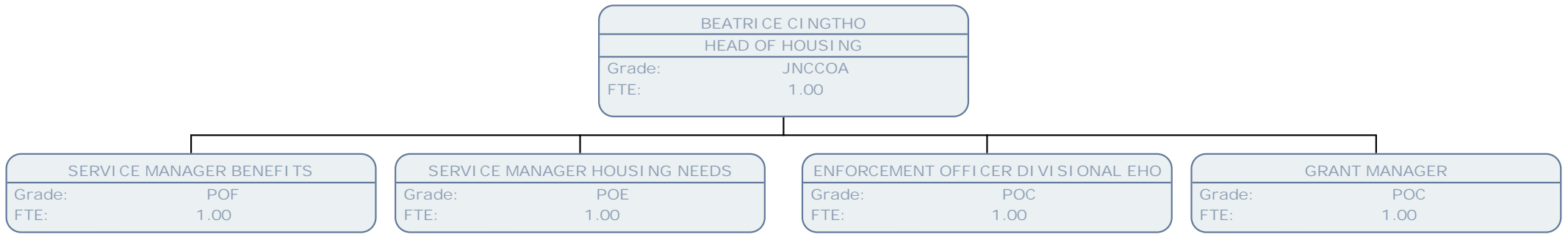

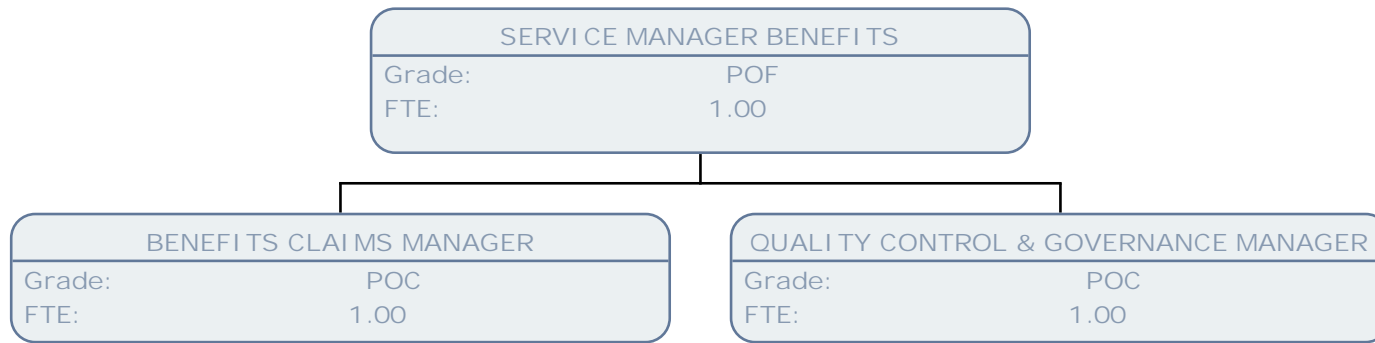

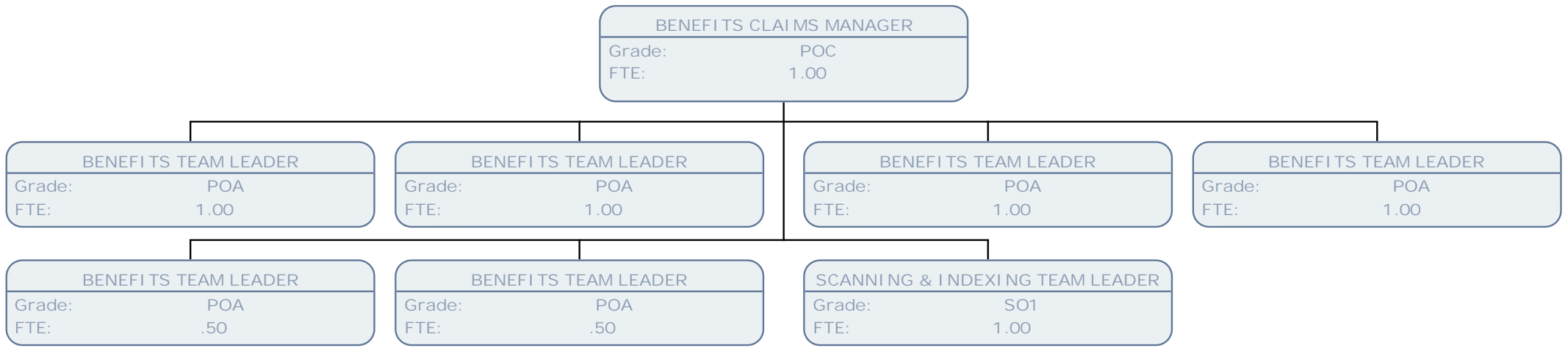

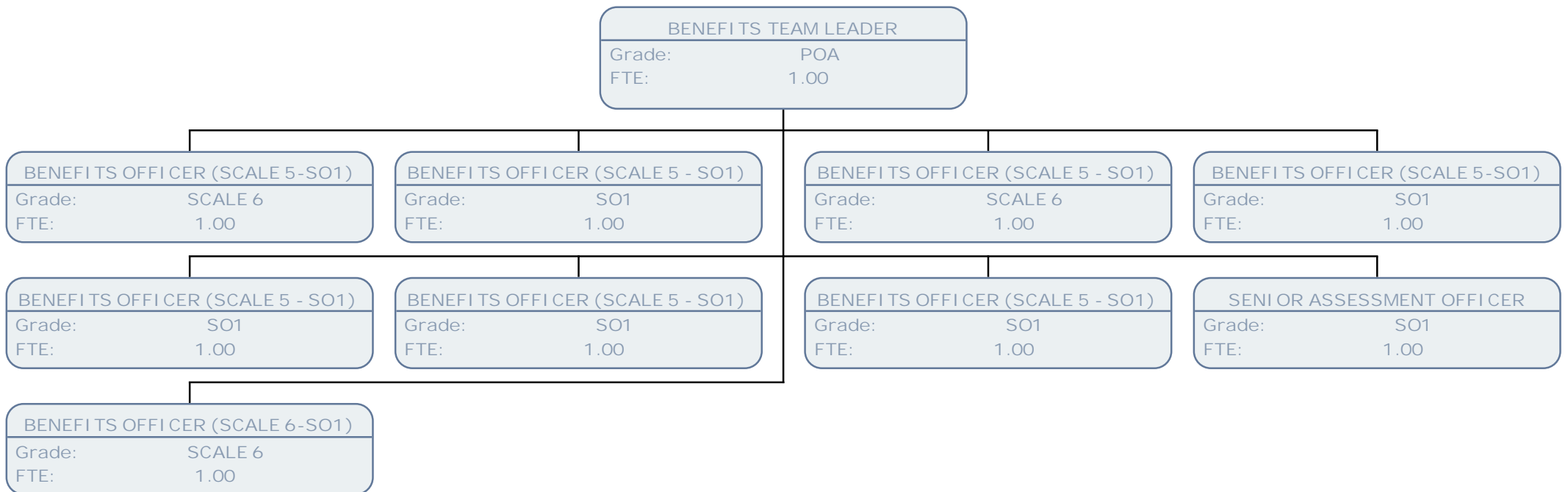

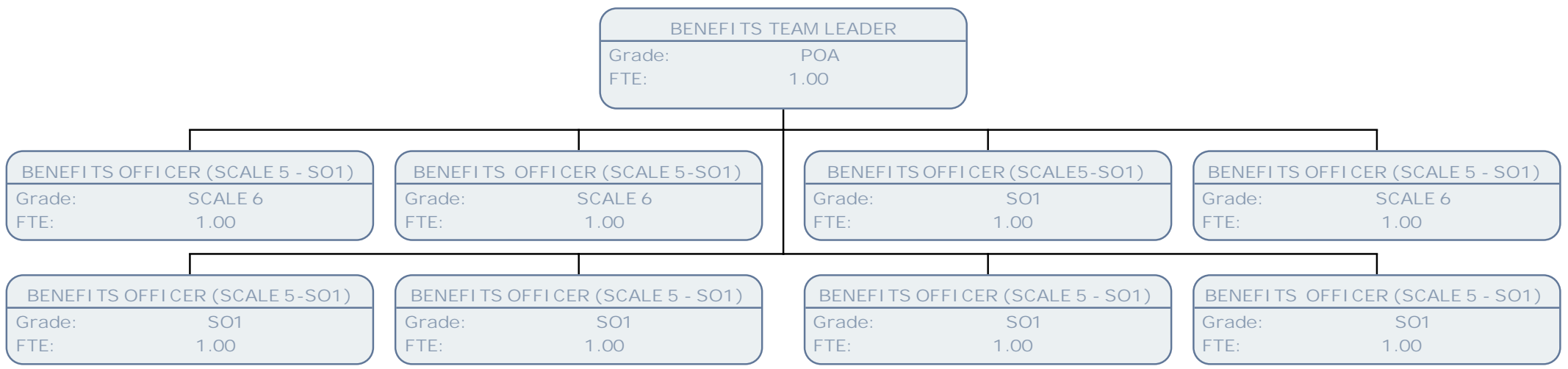

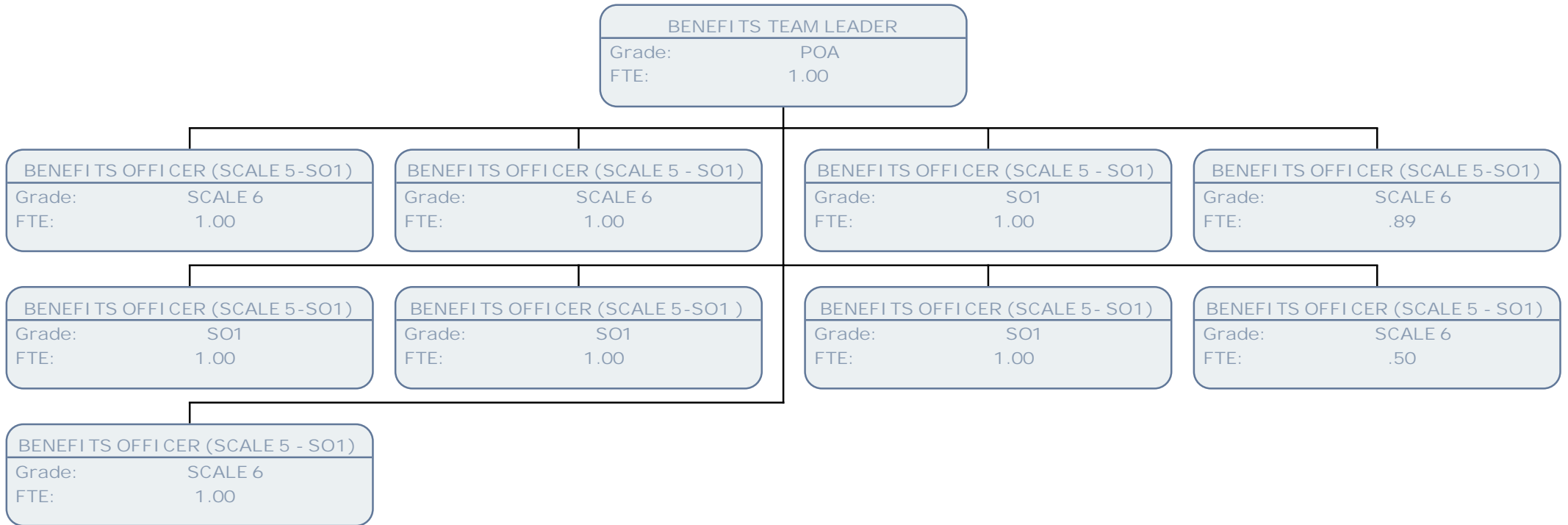

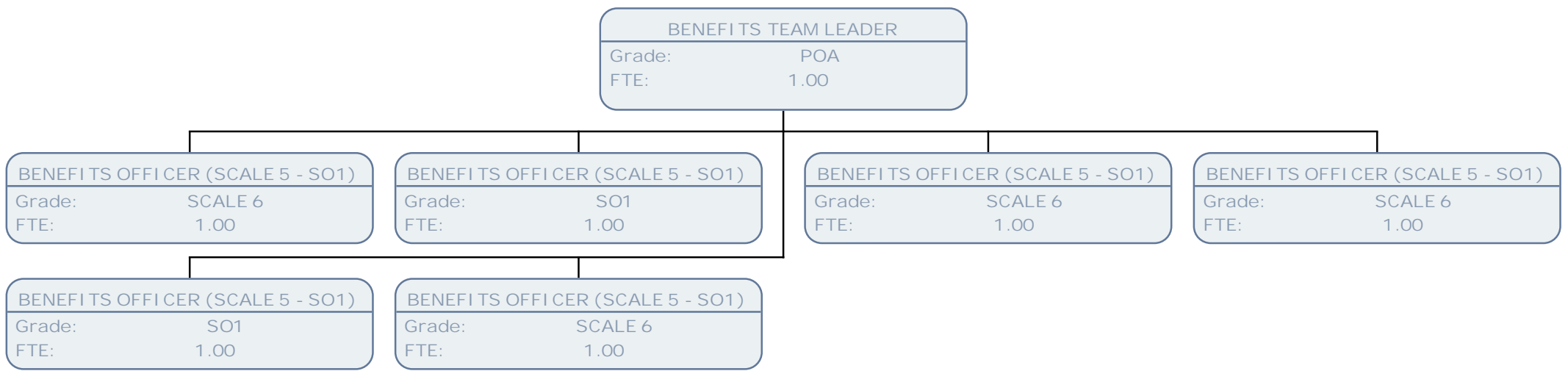

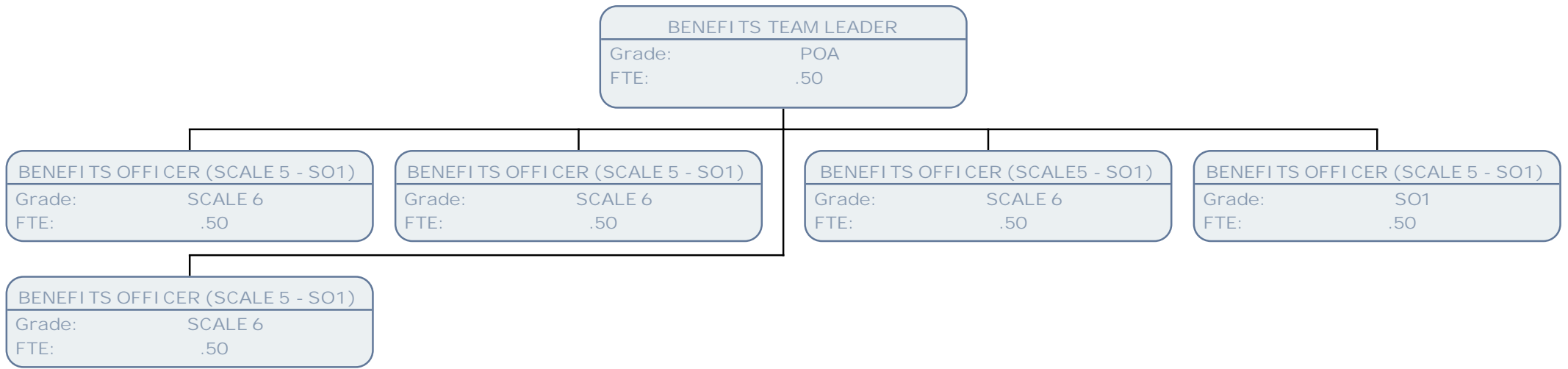

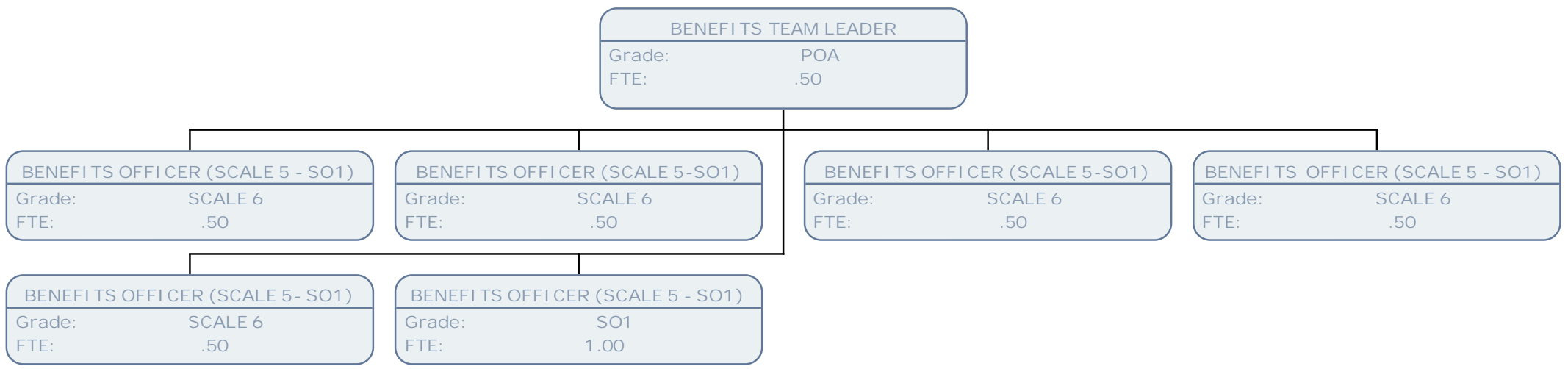

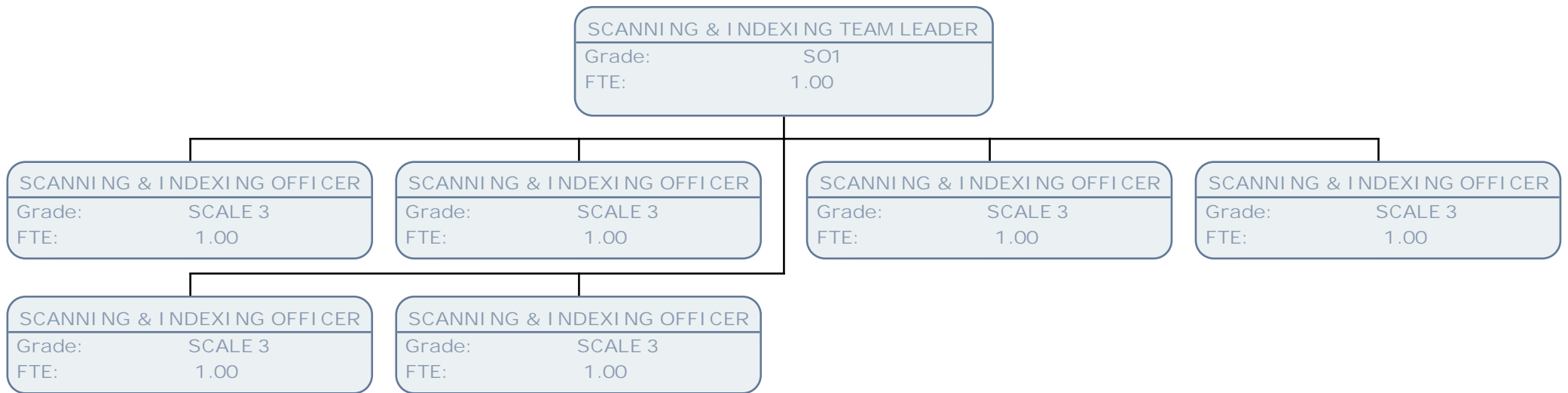

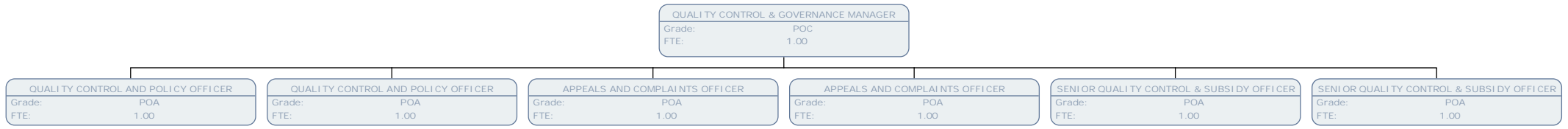

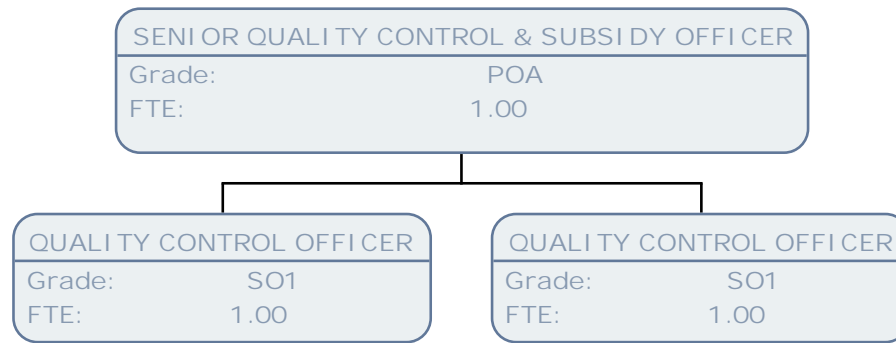

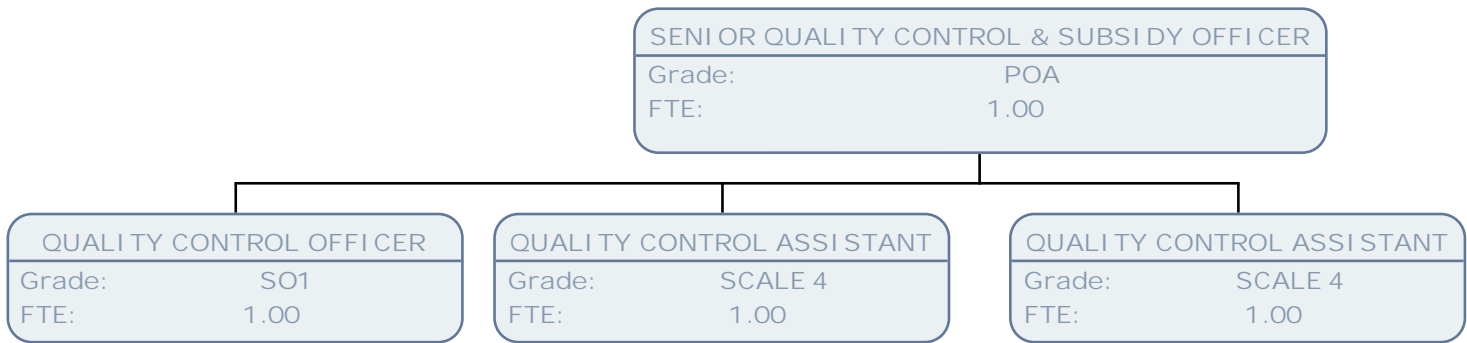

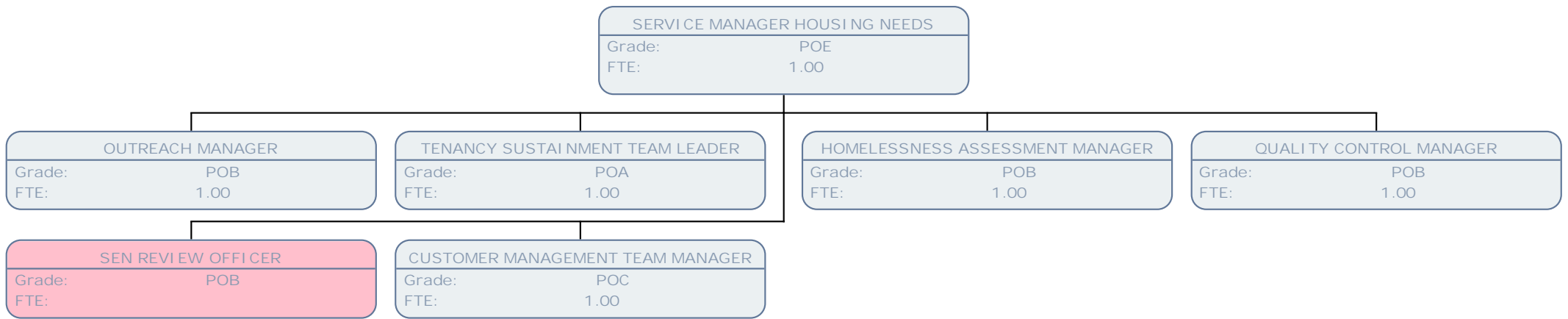

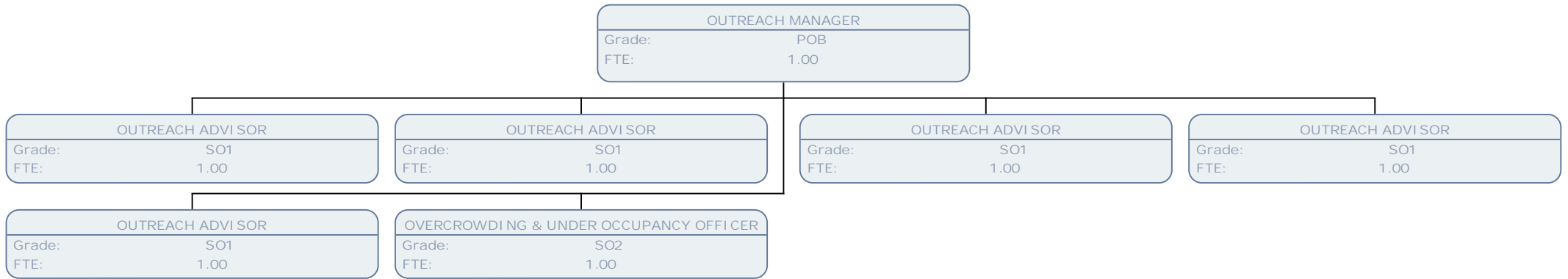

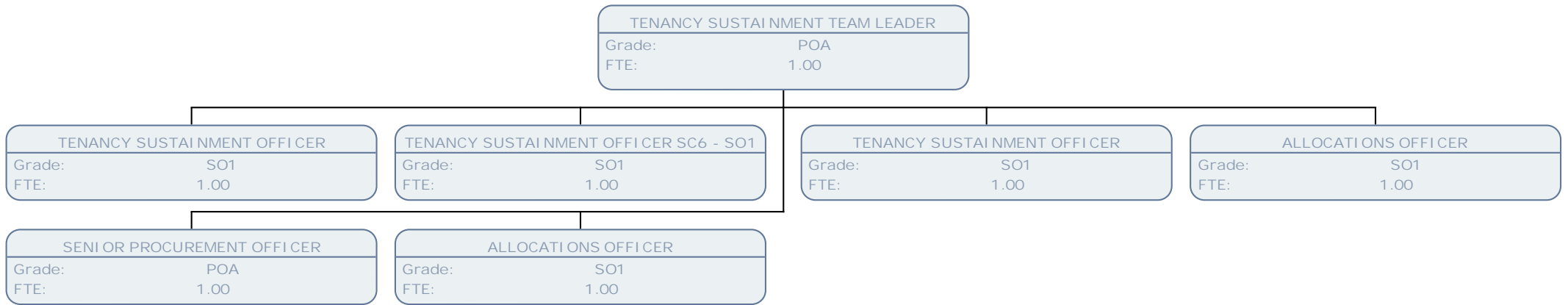

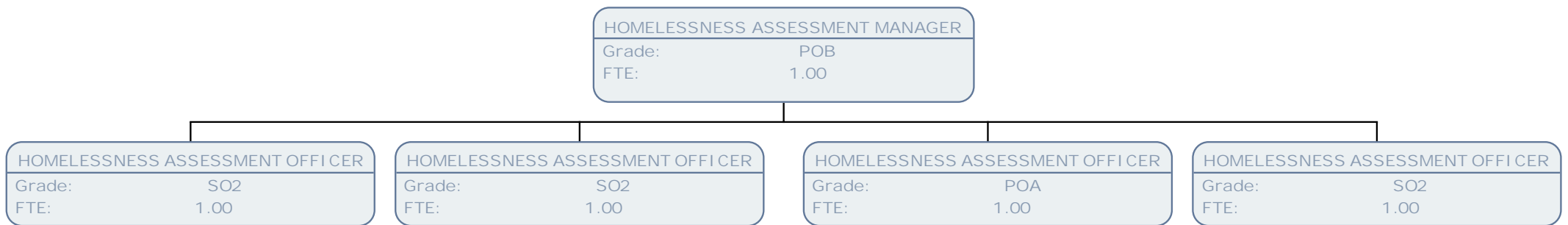

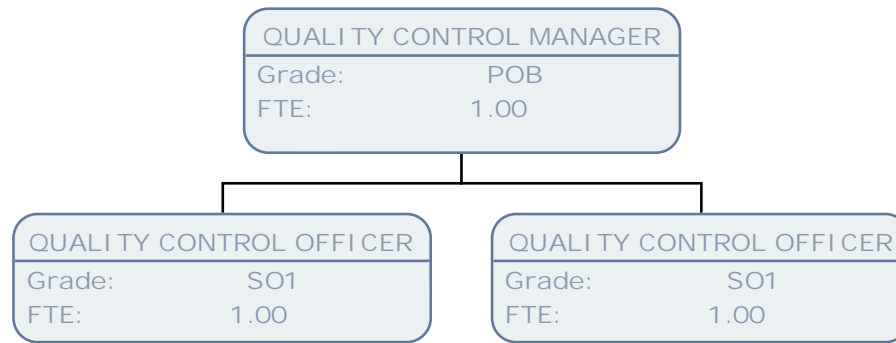

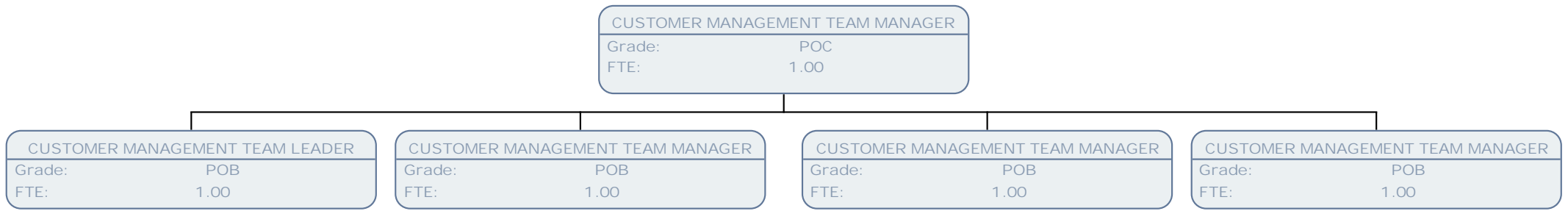

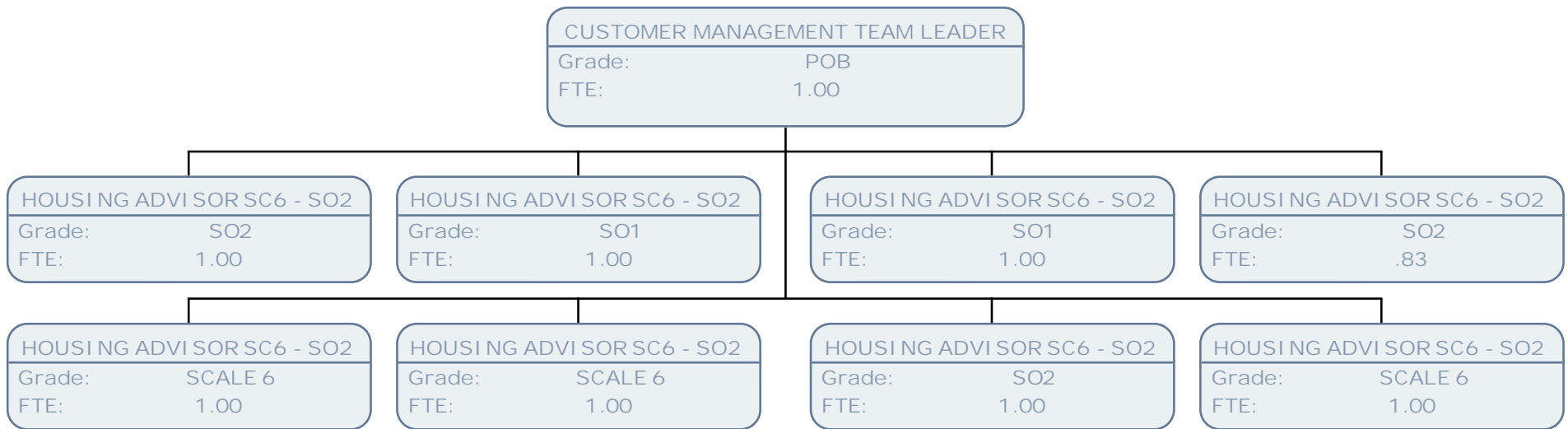

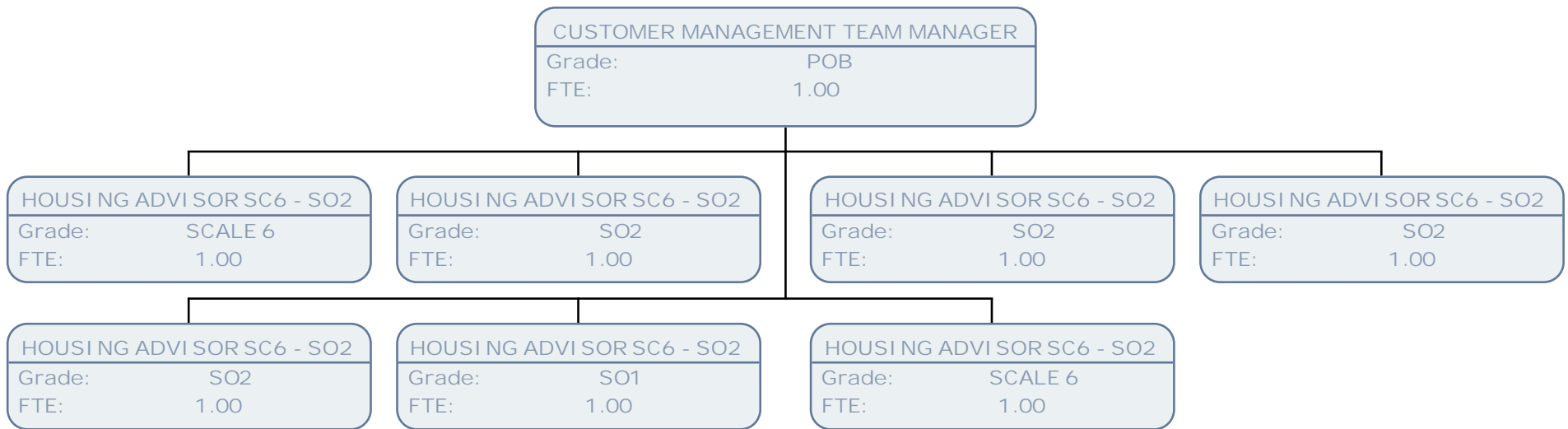

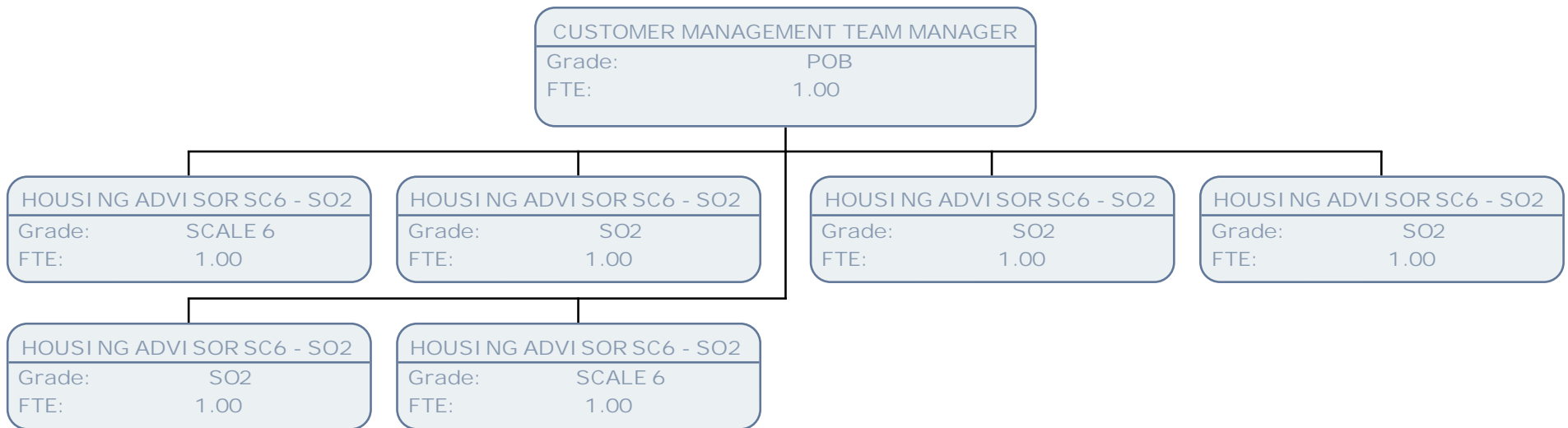

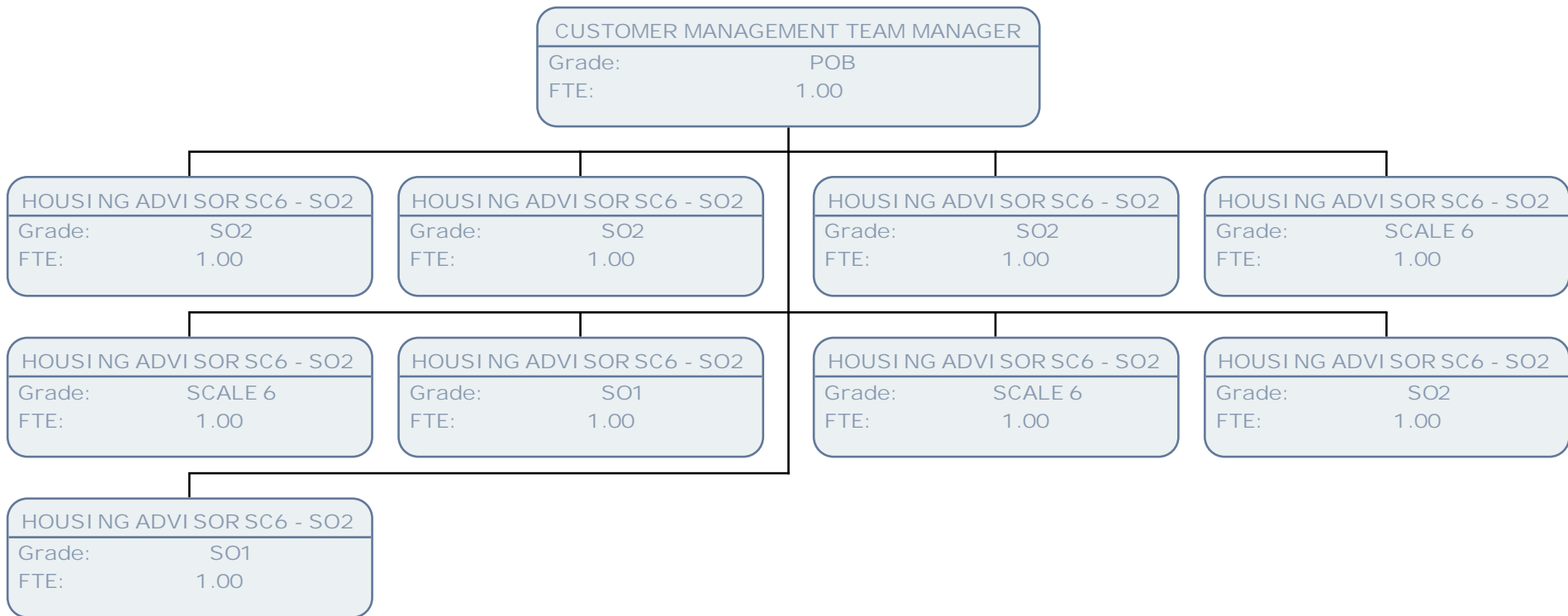

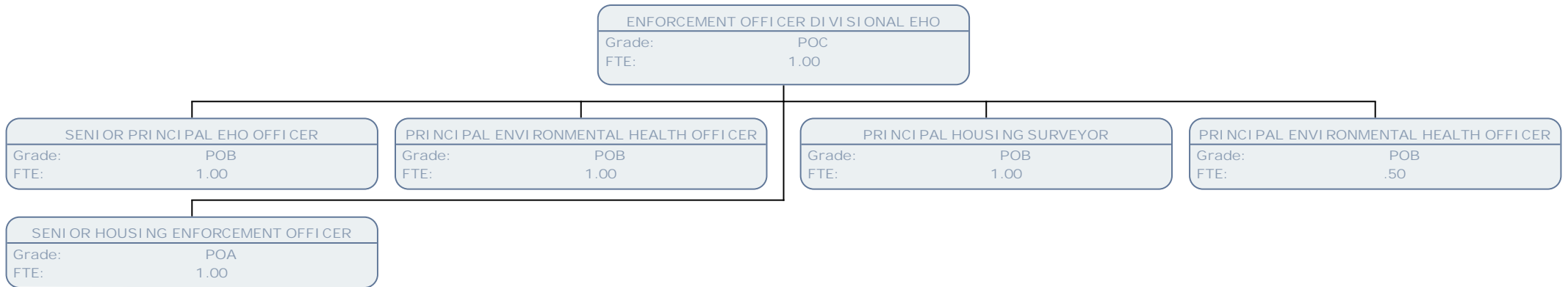

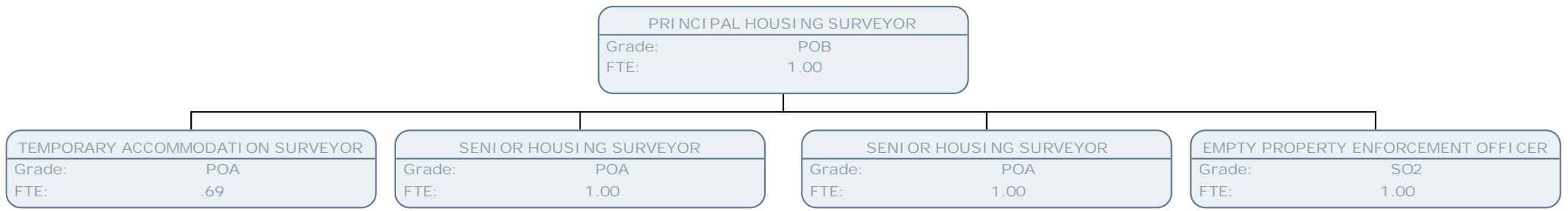

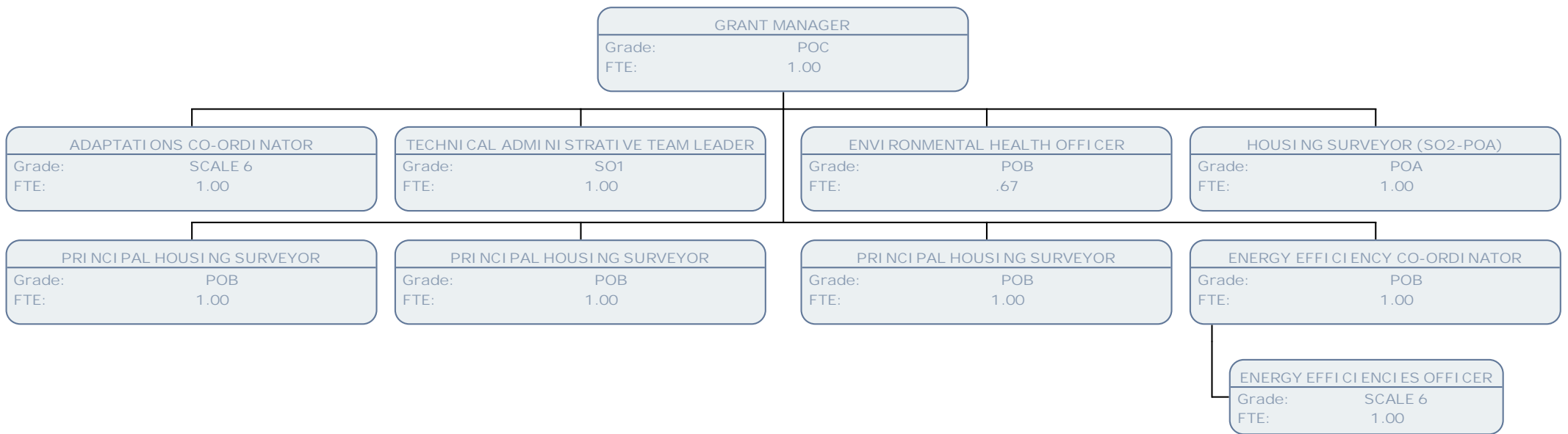

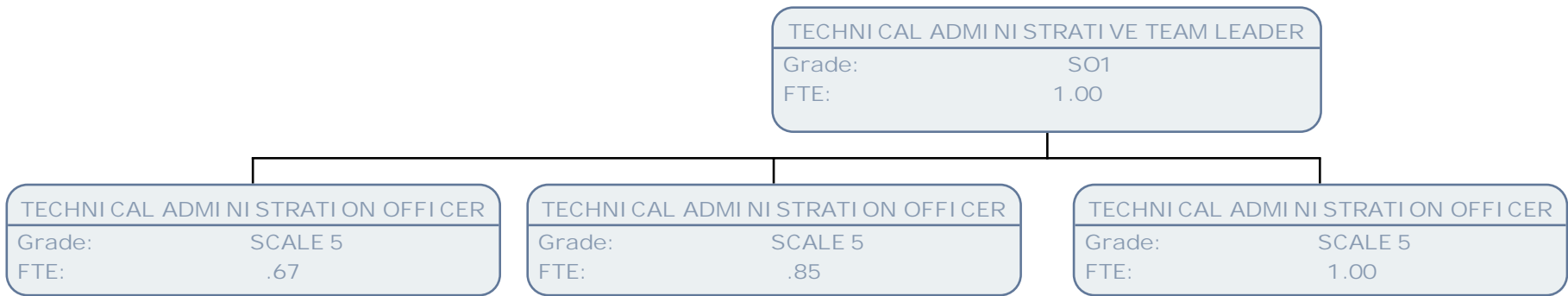

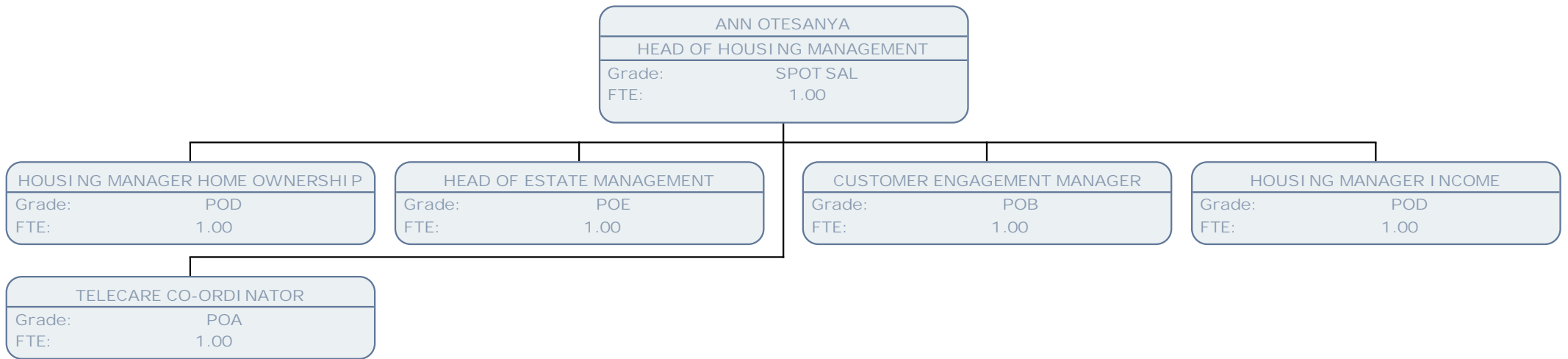

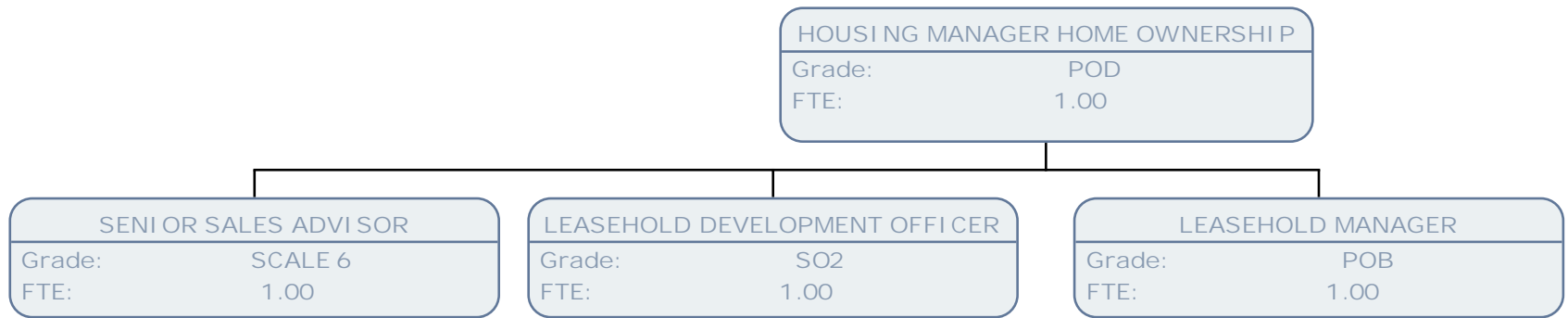

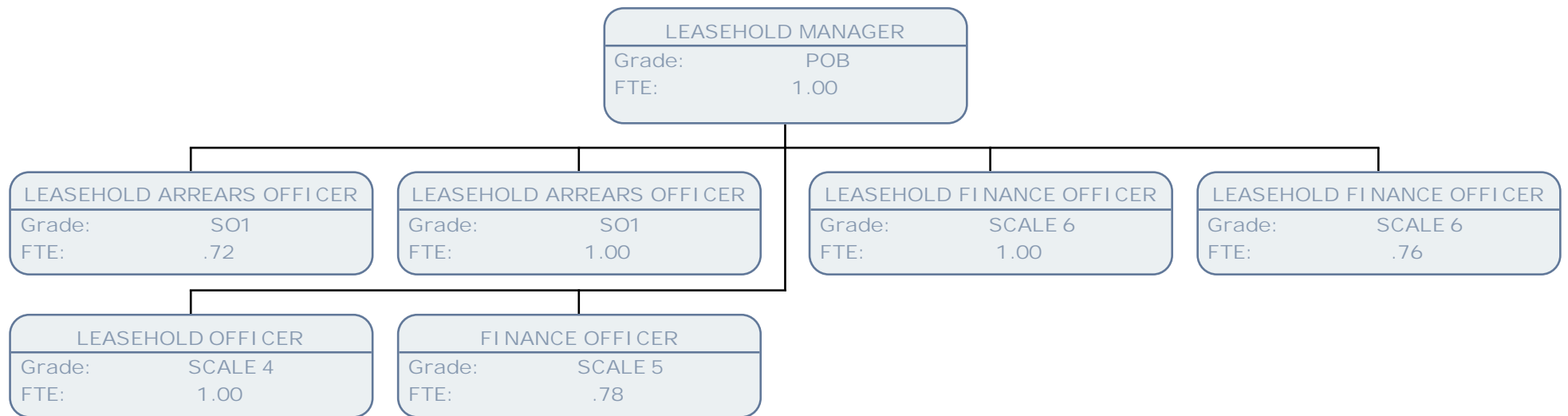

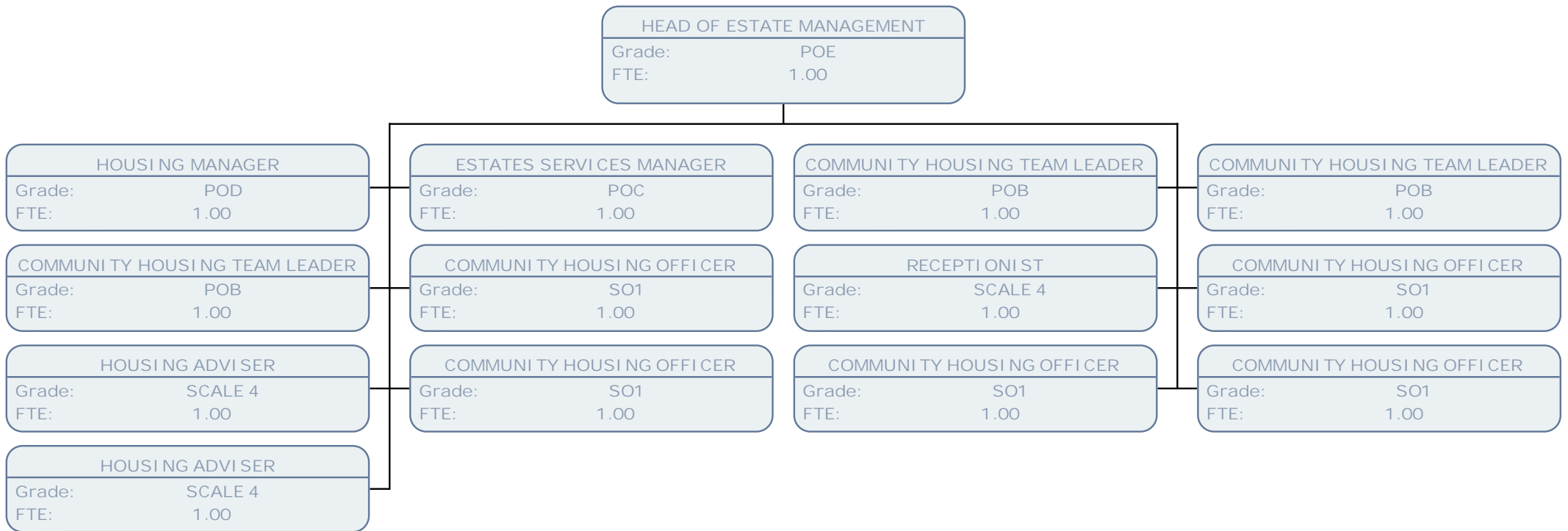

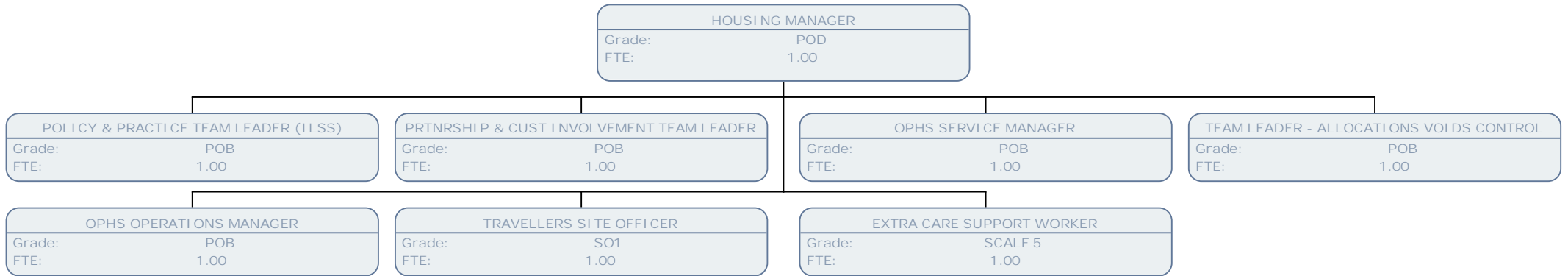

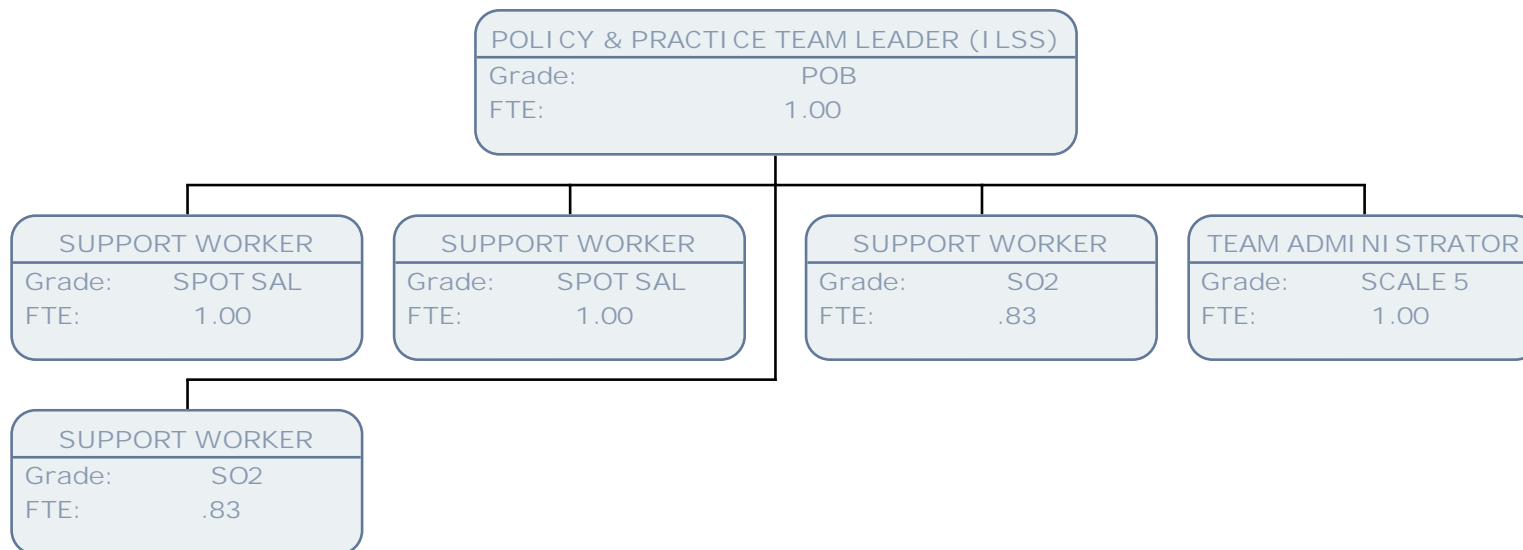

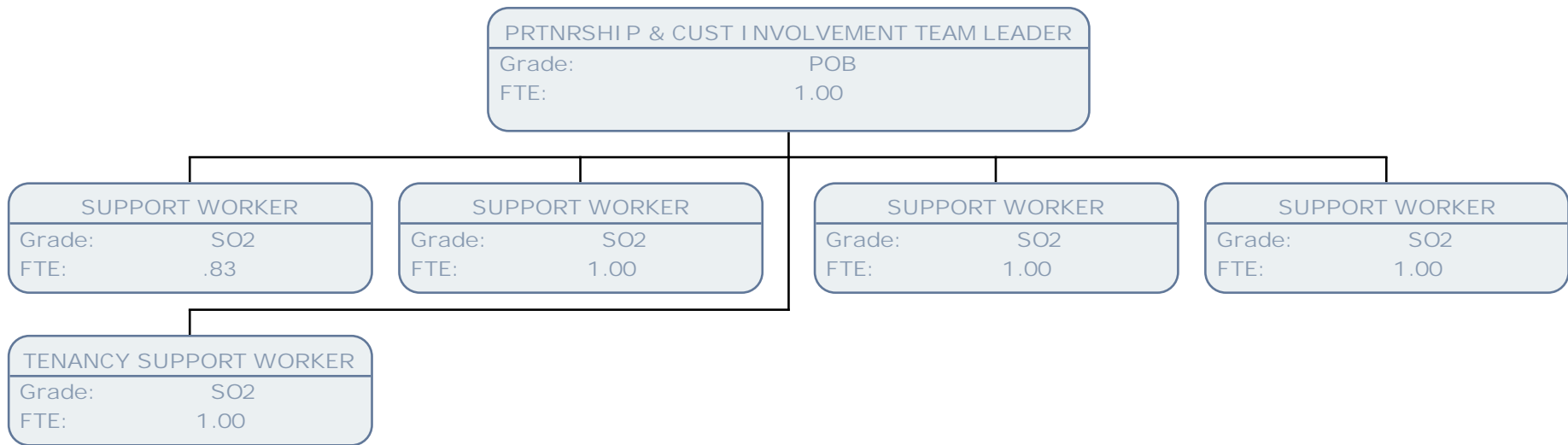

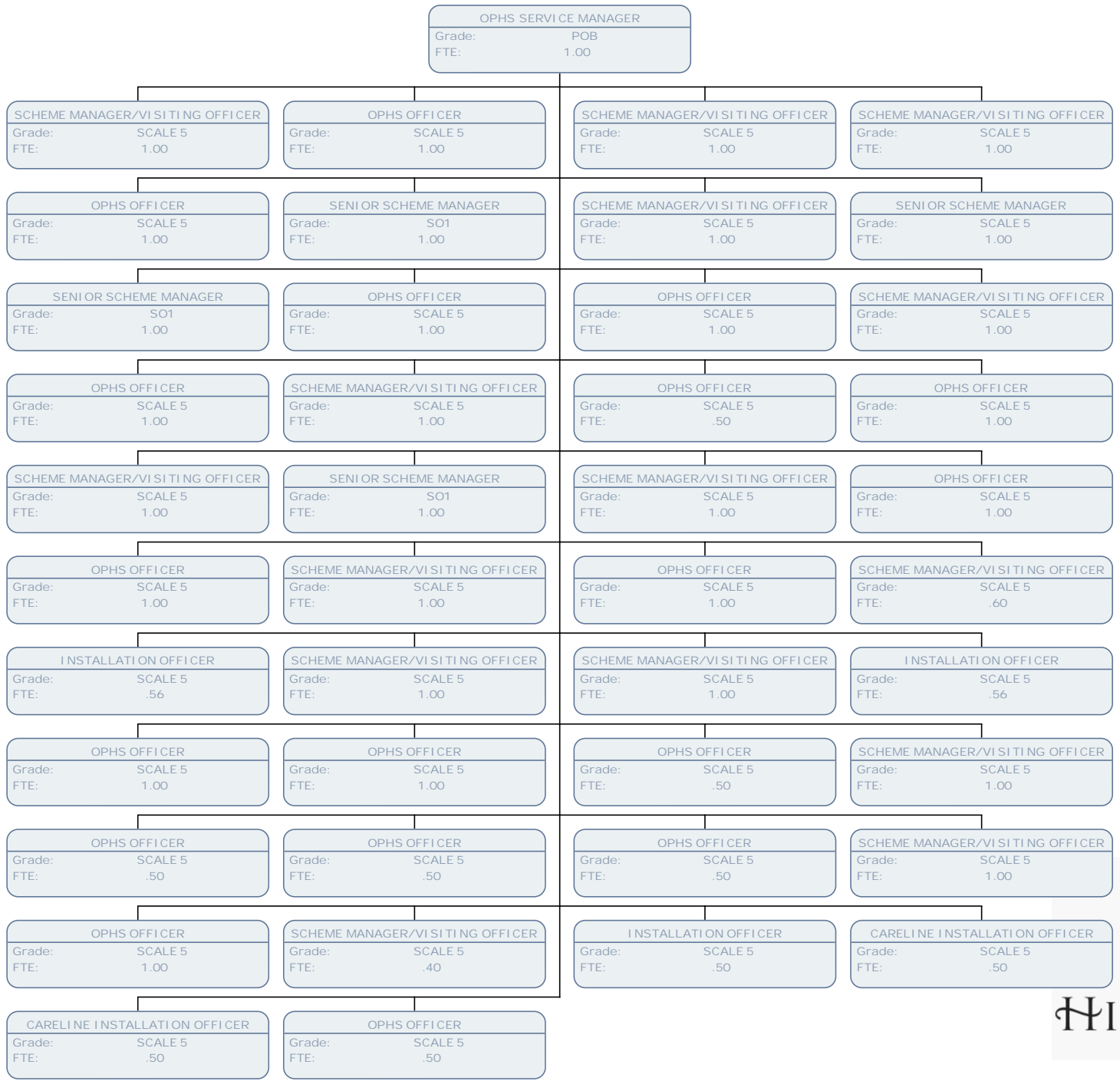

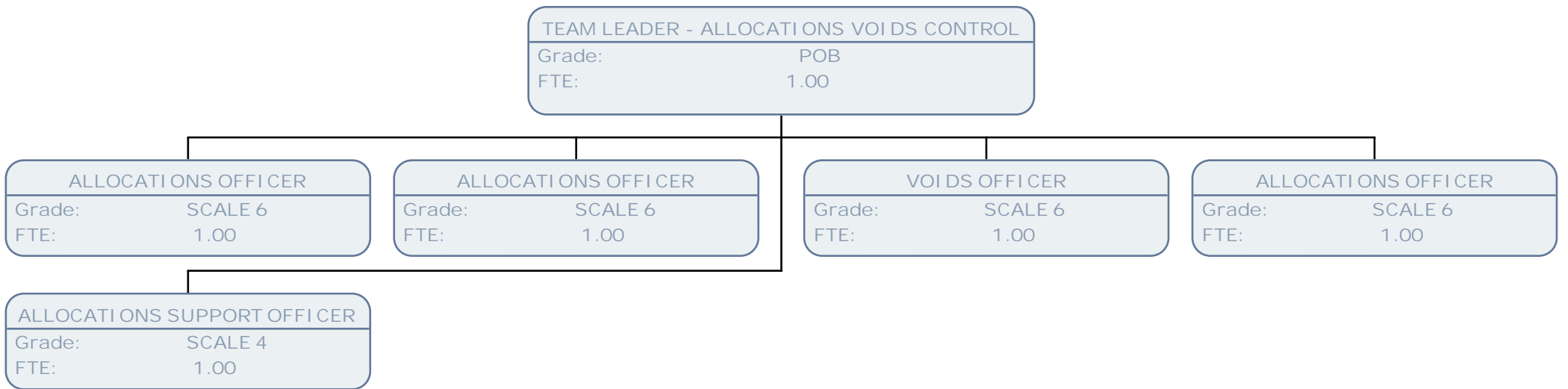

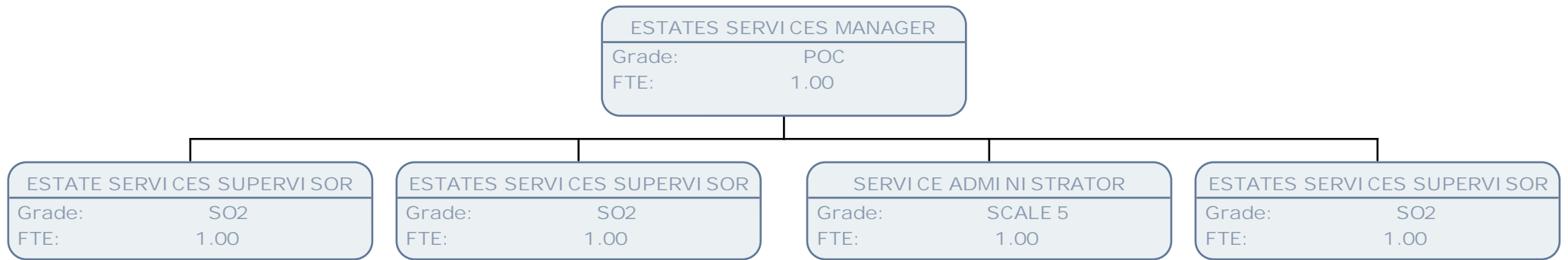

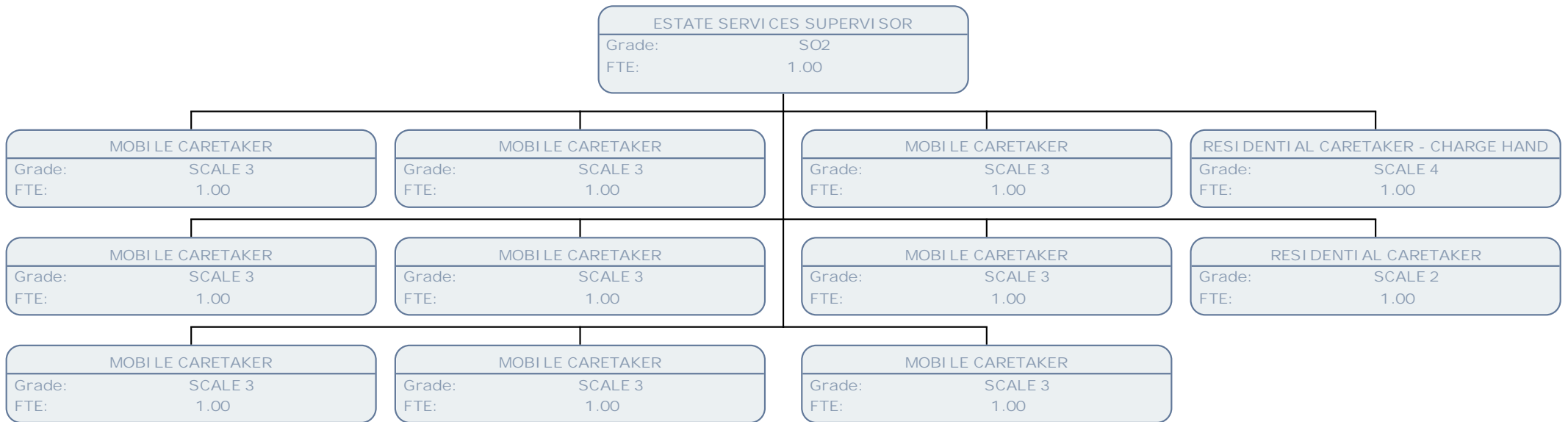

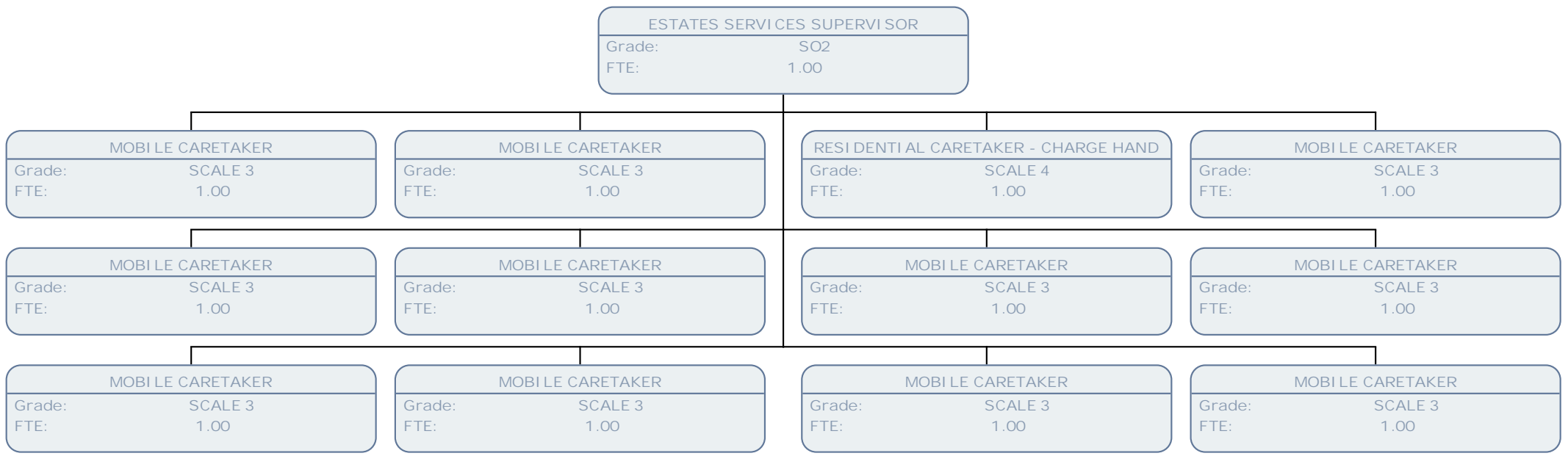

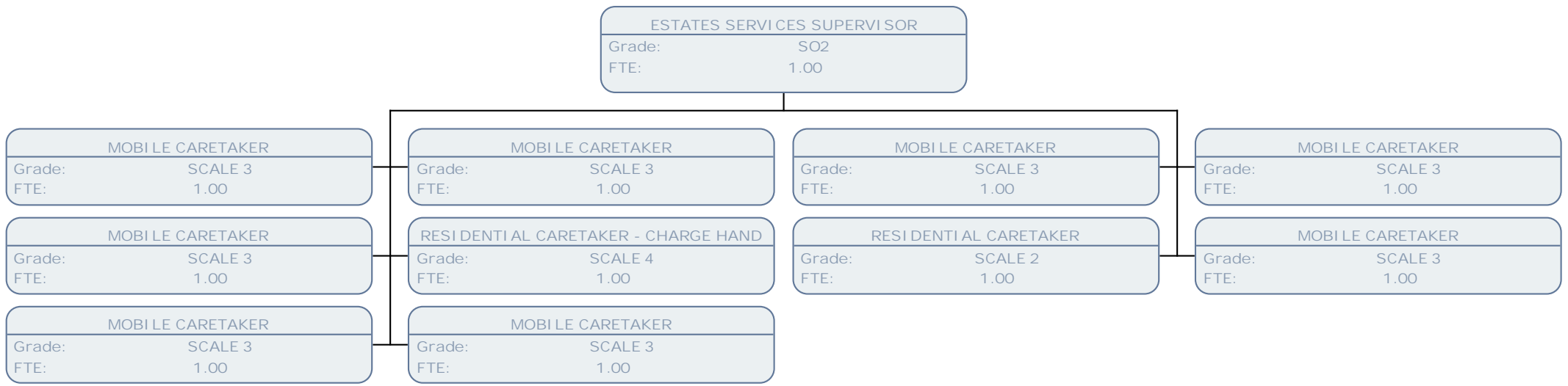

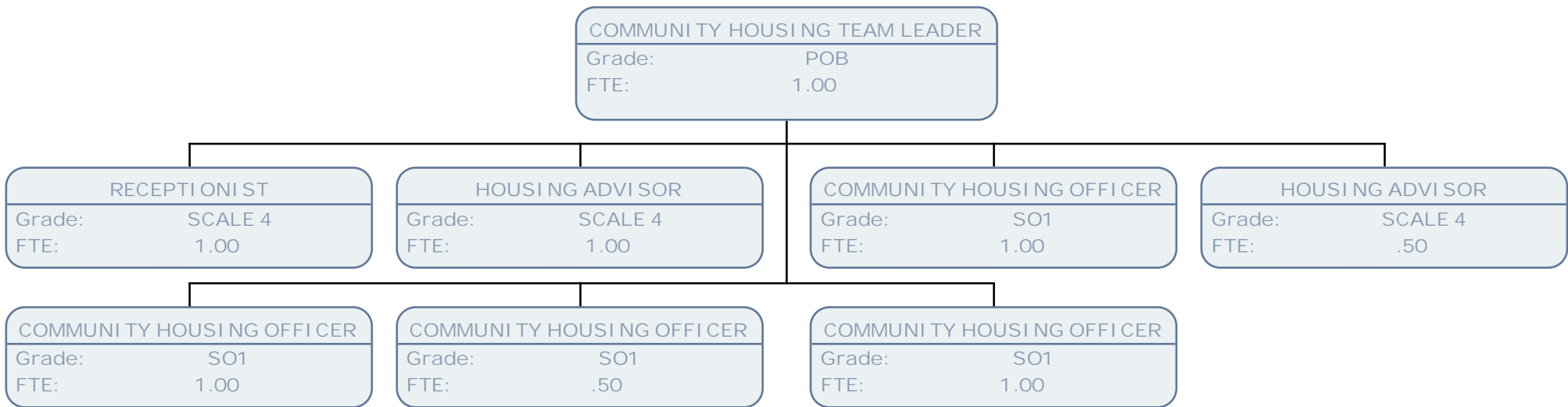

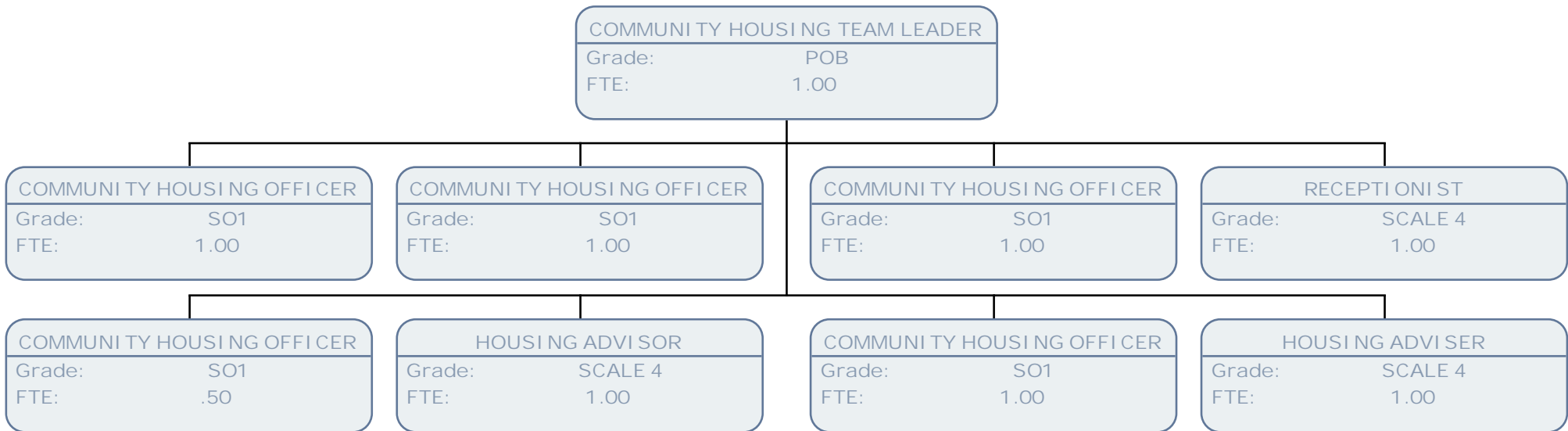

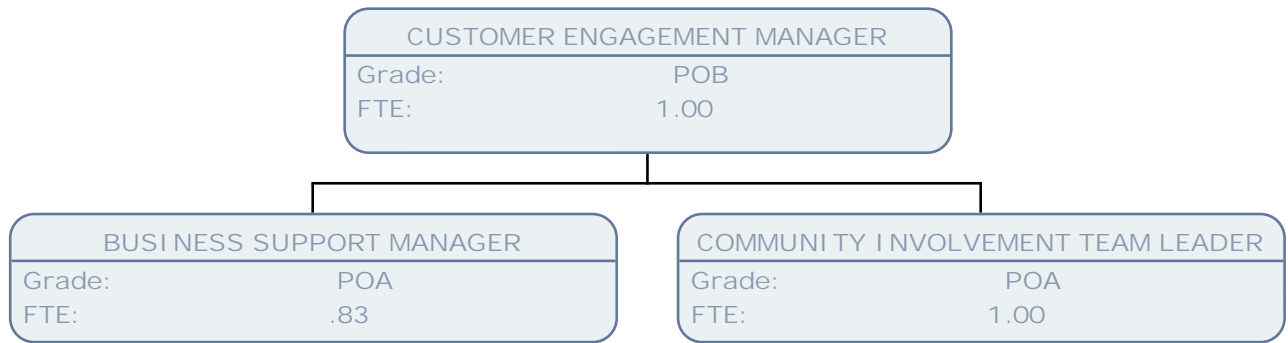

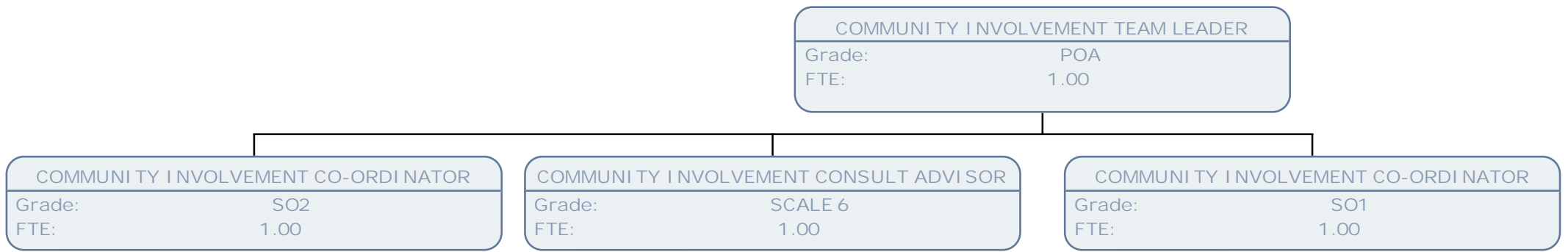

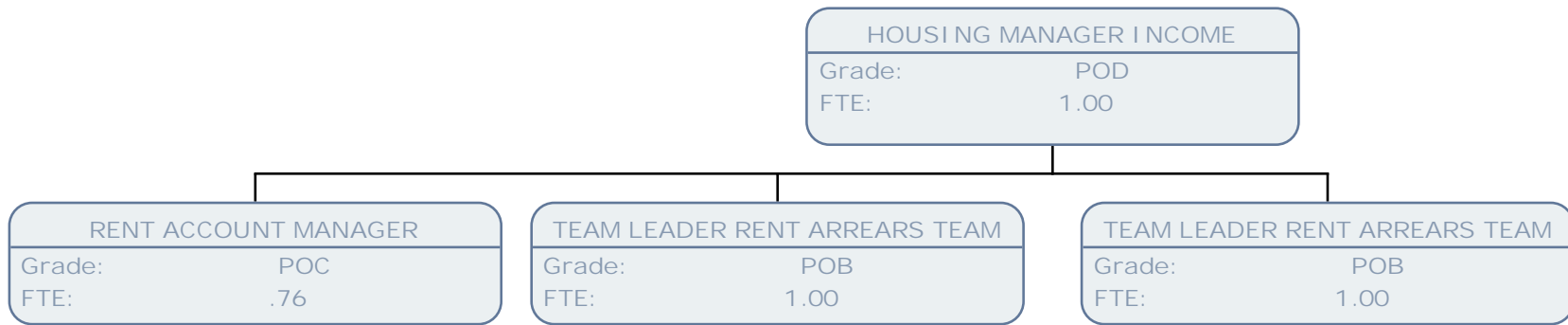

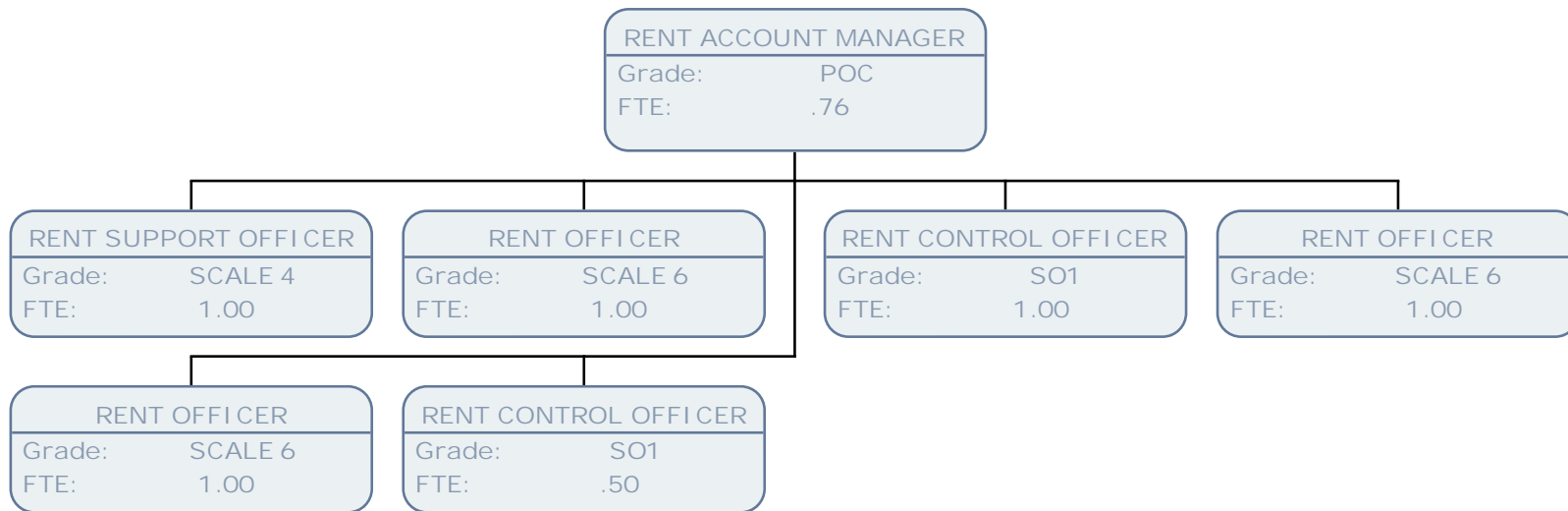

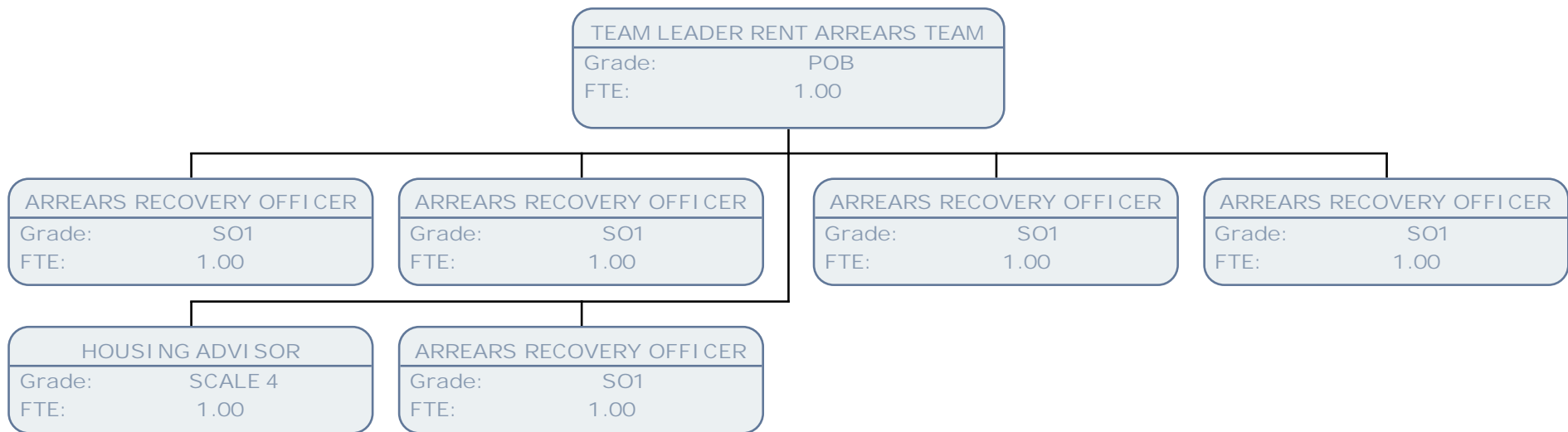

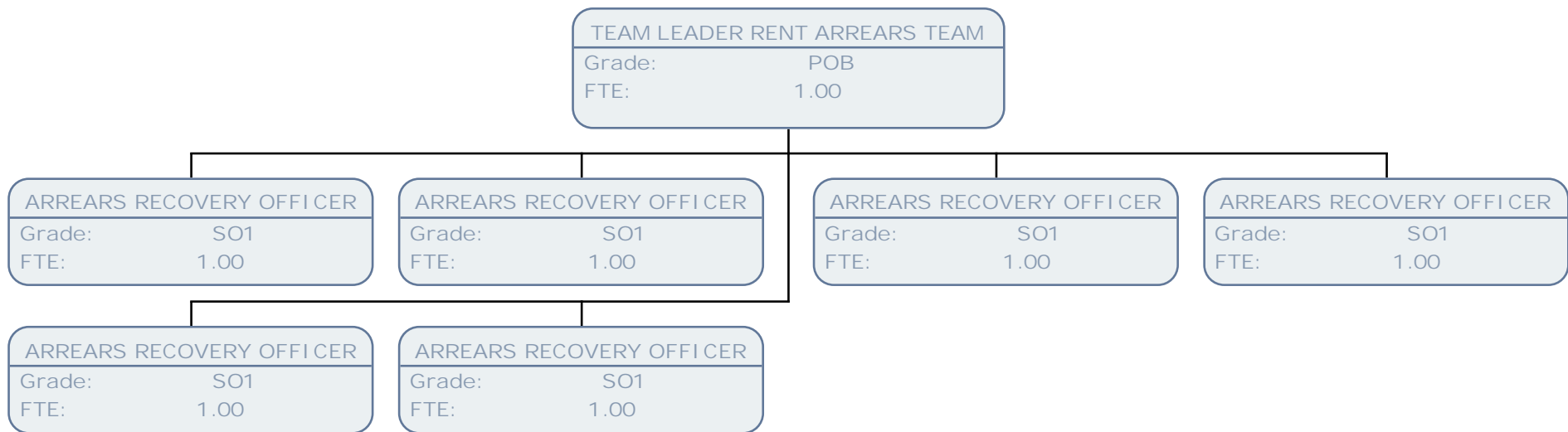

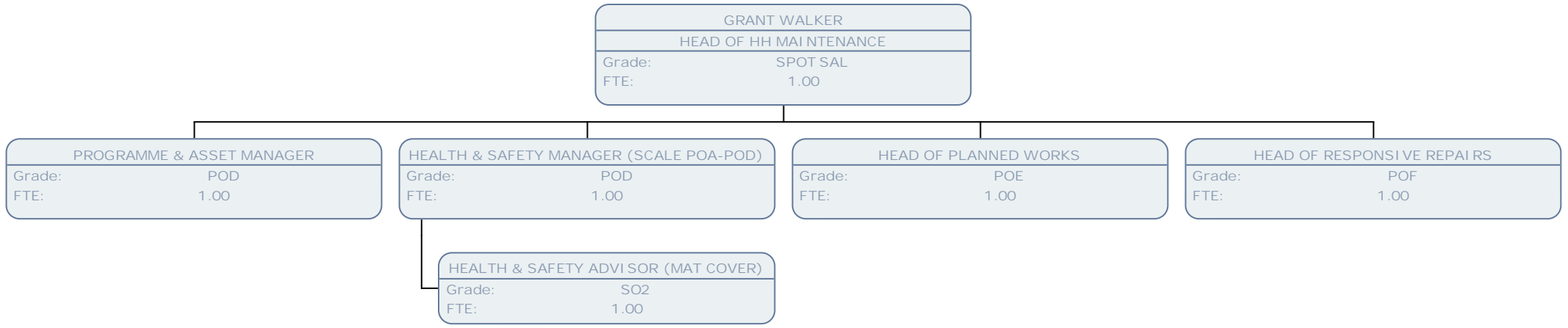

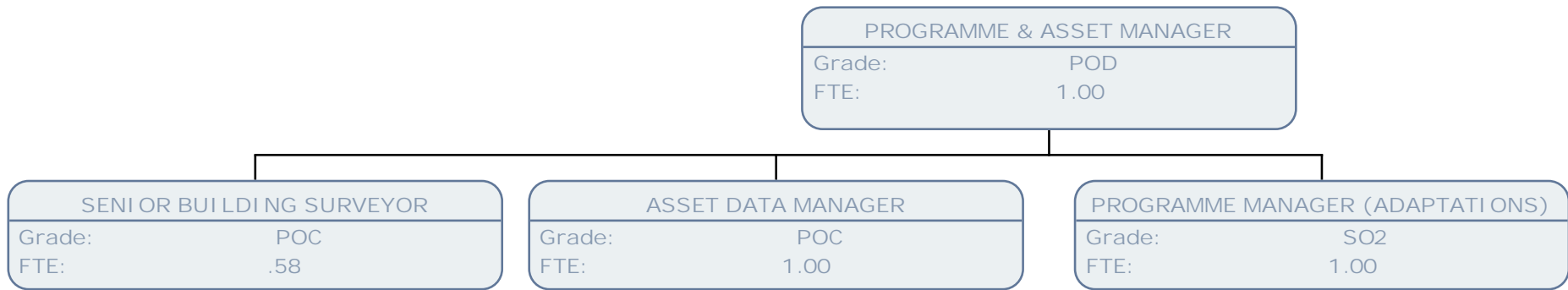

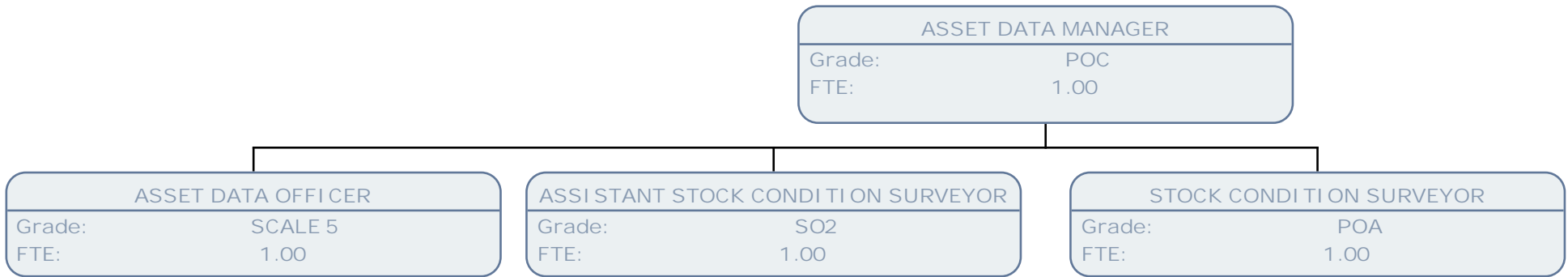

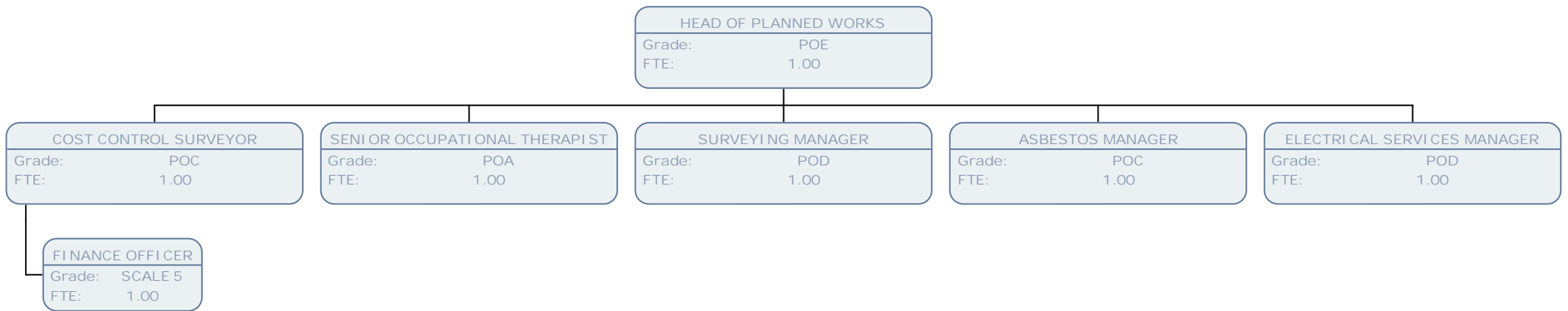

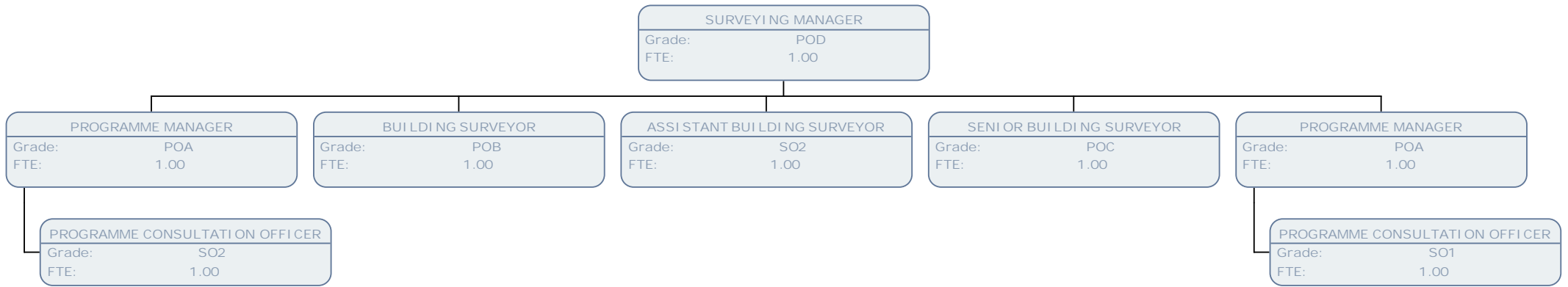

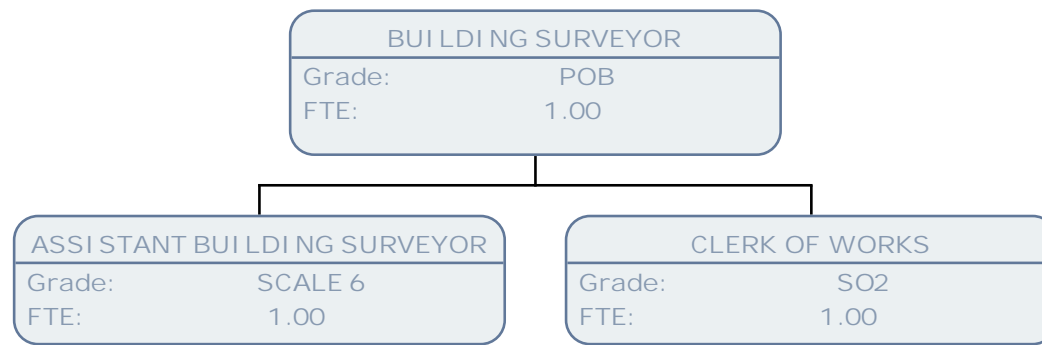

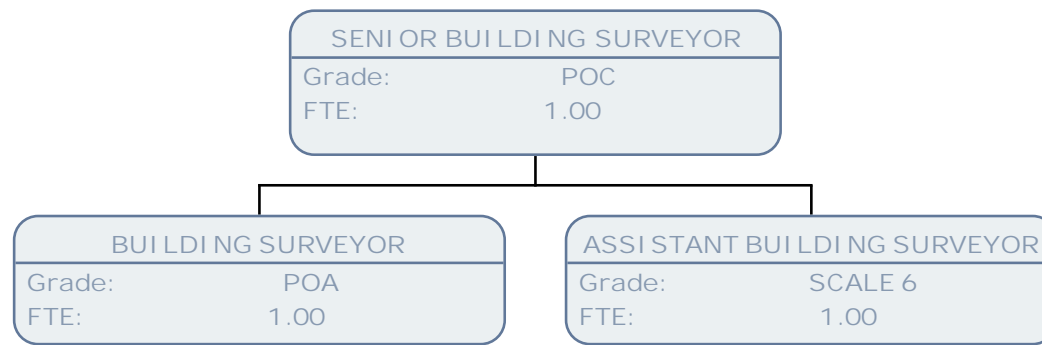

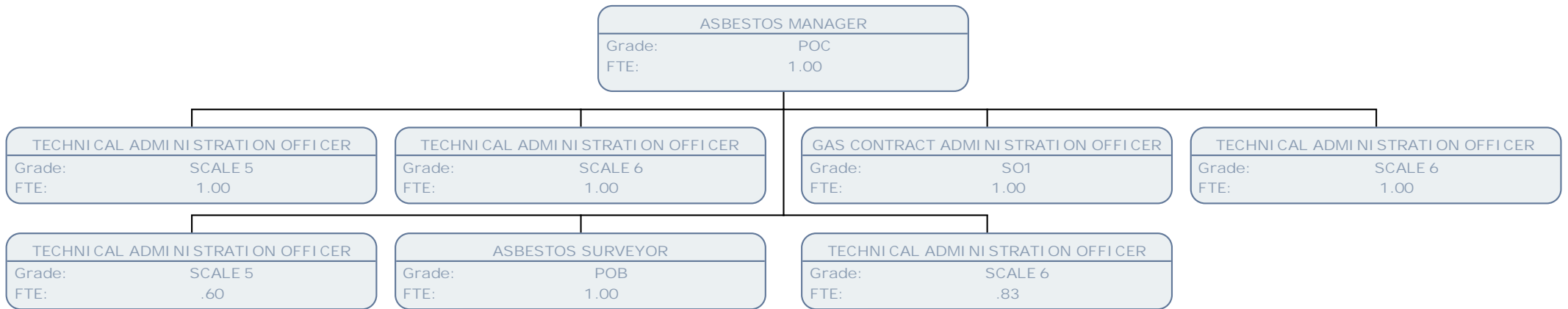

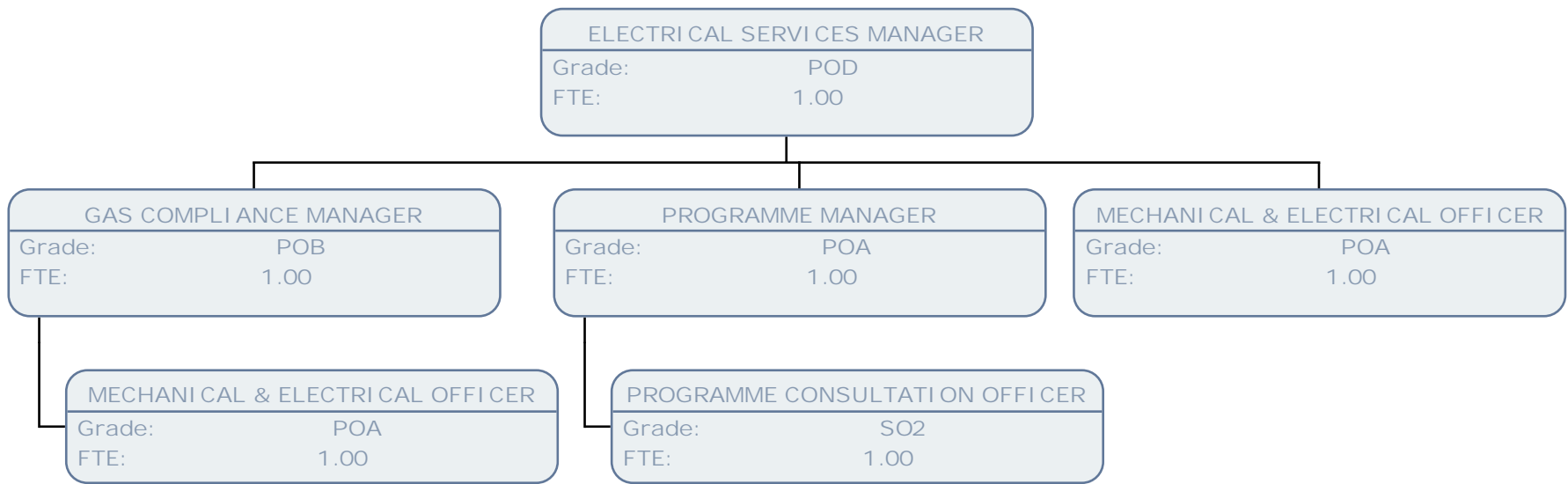

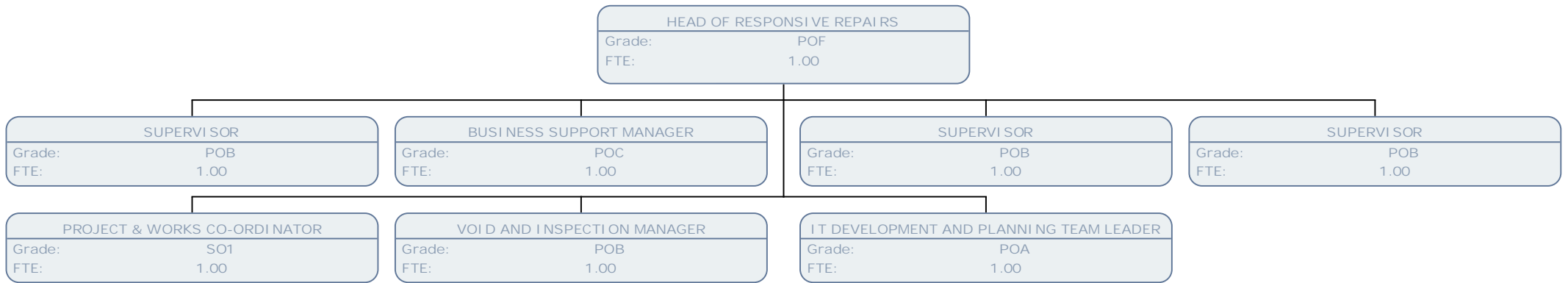

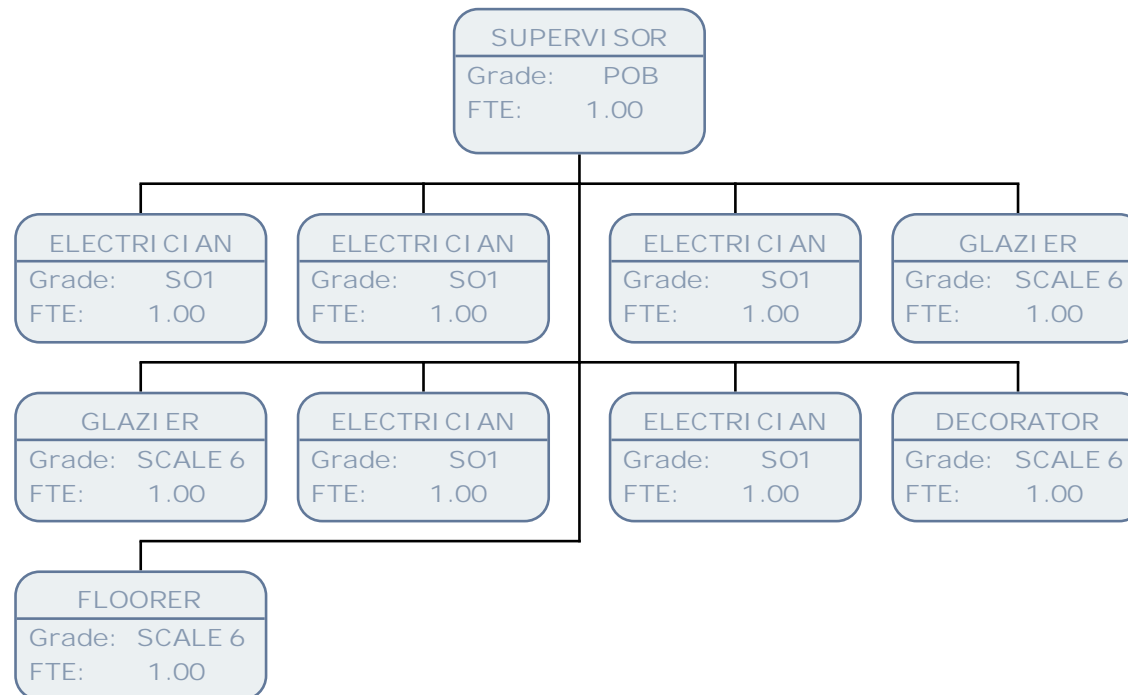

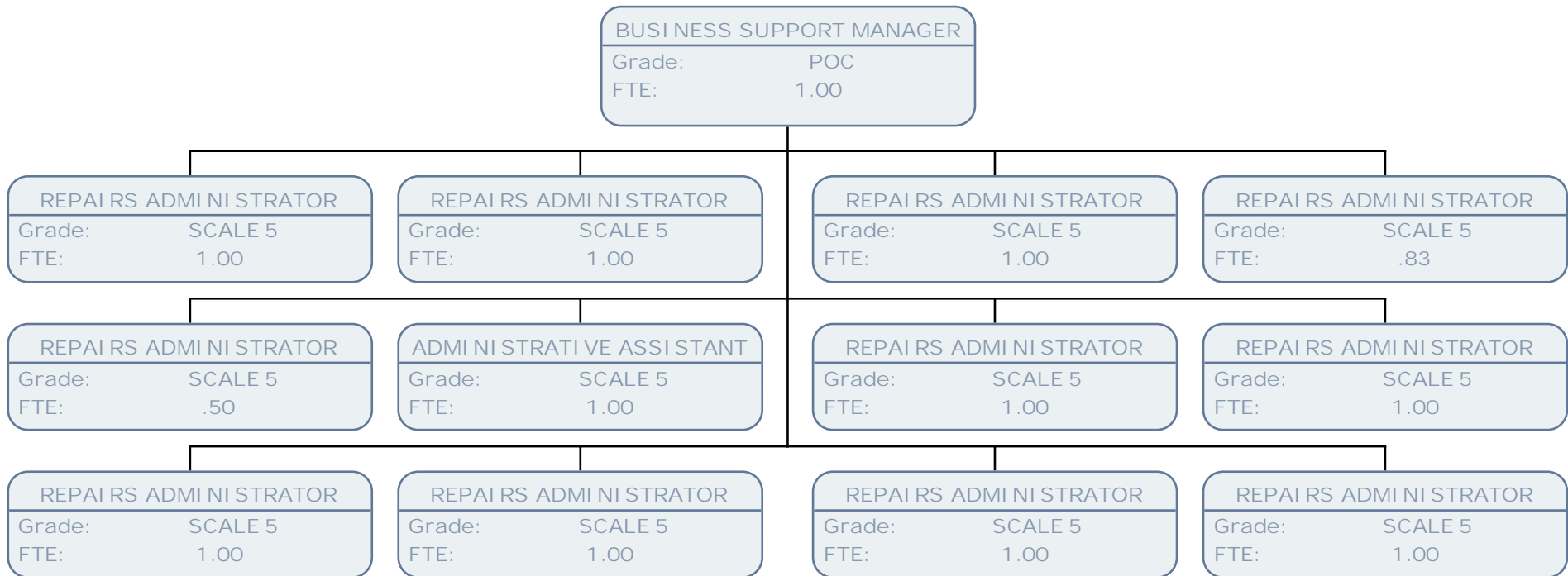

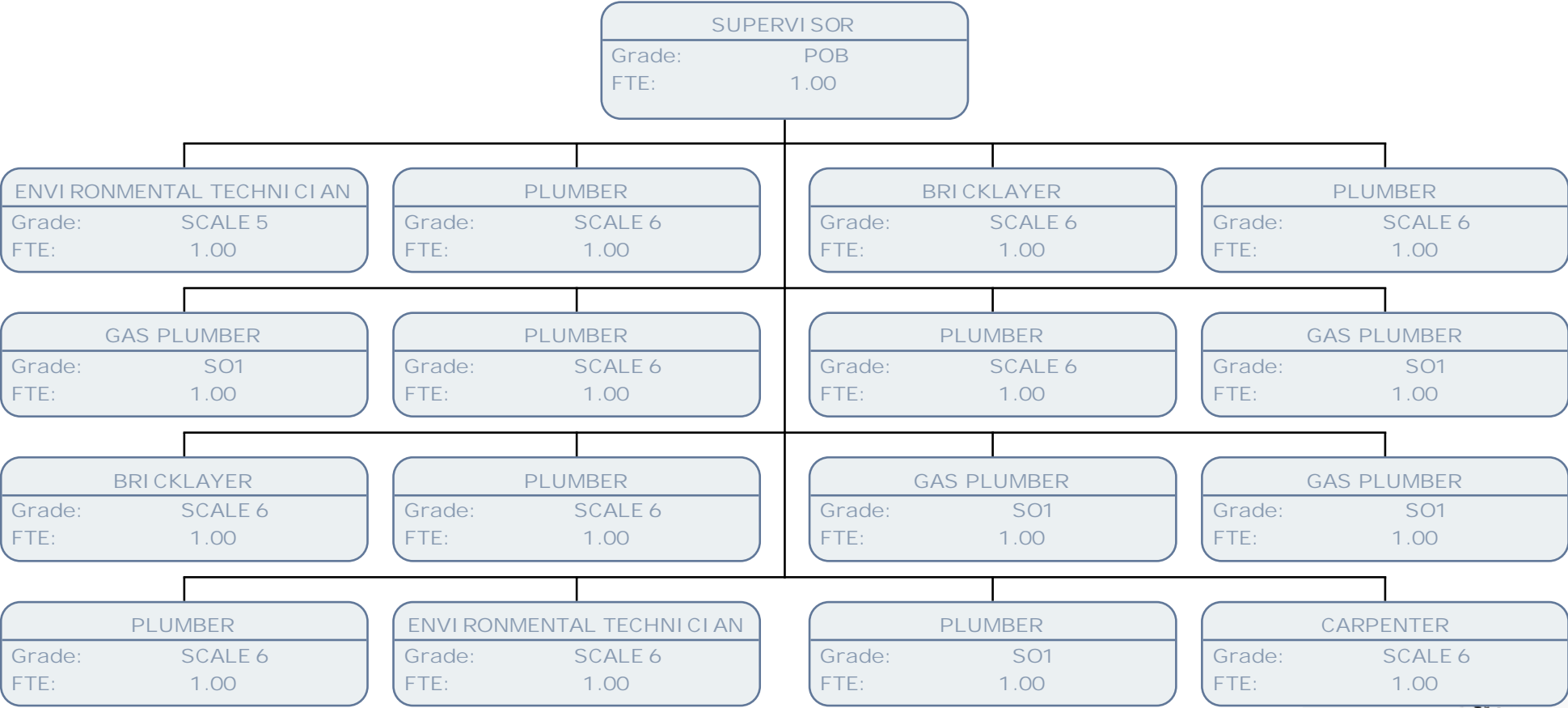

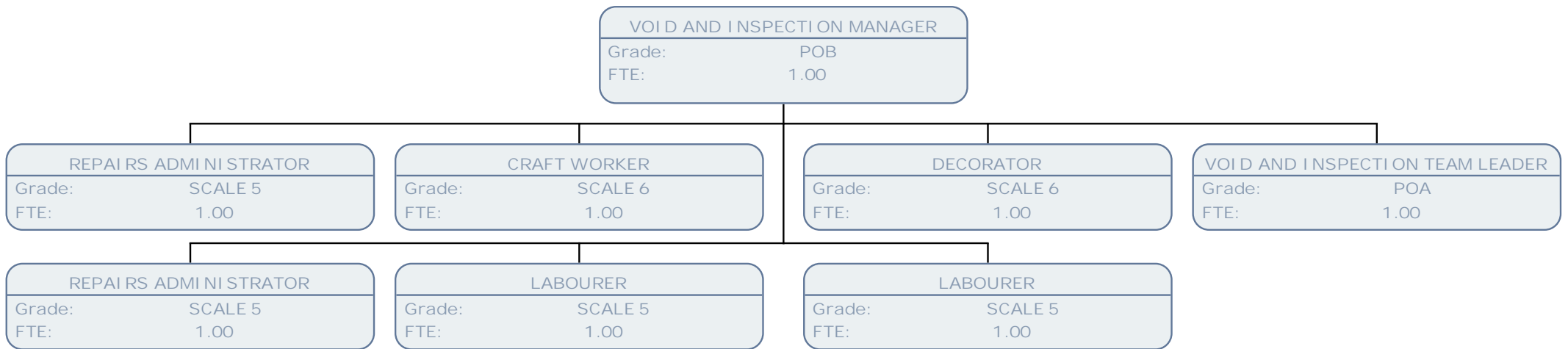

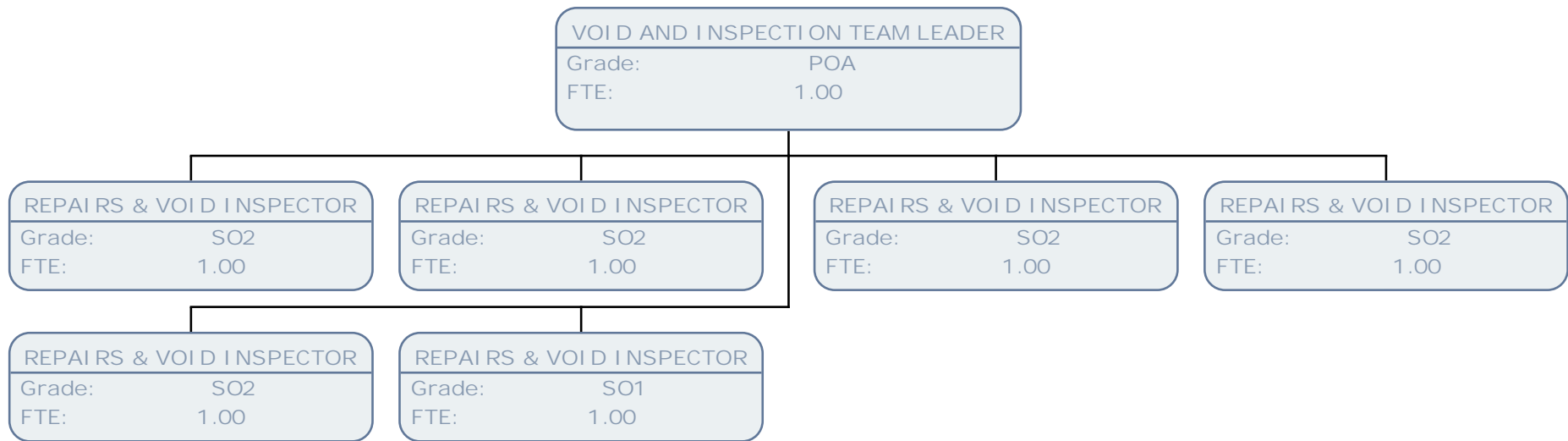

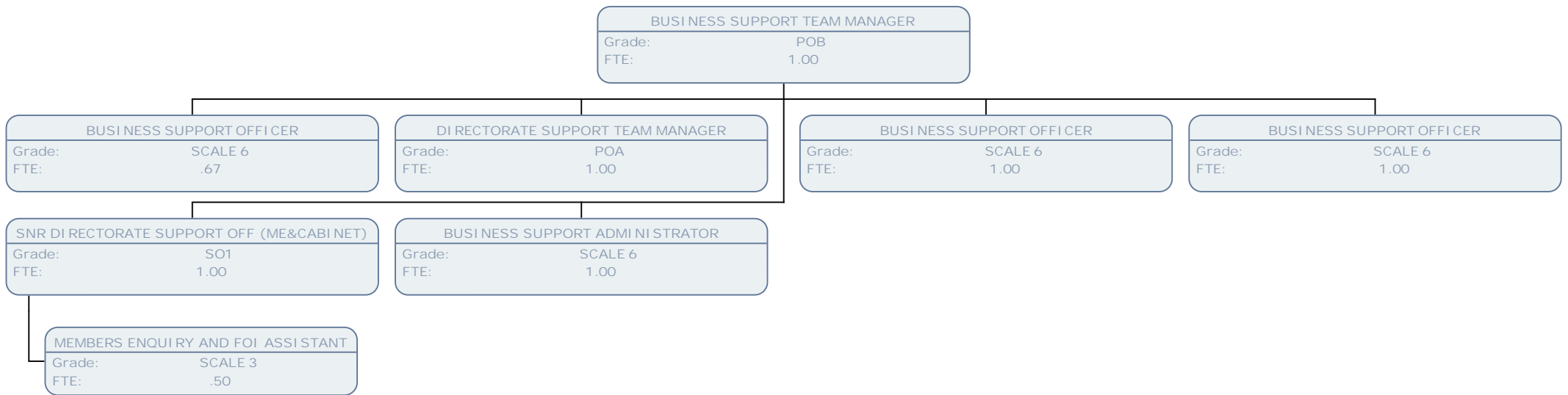

DI RECTORATE SUPPORT TEAM MANAGER	
Grade:	POA
FTE:	1.00

SENIOR DI RECTORATE SUPPORT OFFICER	
Grade:	SO1
FTE:	.42

SENIOR DI RECTORATE SUPPORT OFFICER	
Grade:	SO1
FTE:	1.00

SENIOR DI RECTORATE SUPPORT OFFICER	
Grade:	SO1
FTE:	.56

SENIOR DI RECTORATE SUPPORT OFFICER	
Grade:	SO1
FTE:	1.00

SENIOR DI RECTORATE SUPPORT OFFICER	
Grade:	SO1
FTE:	.50

SENIOR DI RECTORATE SUPPORT OFFICER	
Grade:	SO1
FTE:	1.00

PERSONAL ASSISTANT TO HEAD HSG MGMT	
Grade:	SCALE 6
FTE:	1.00



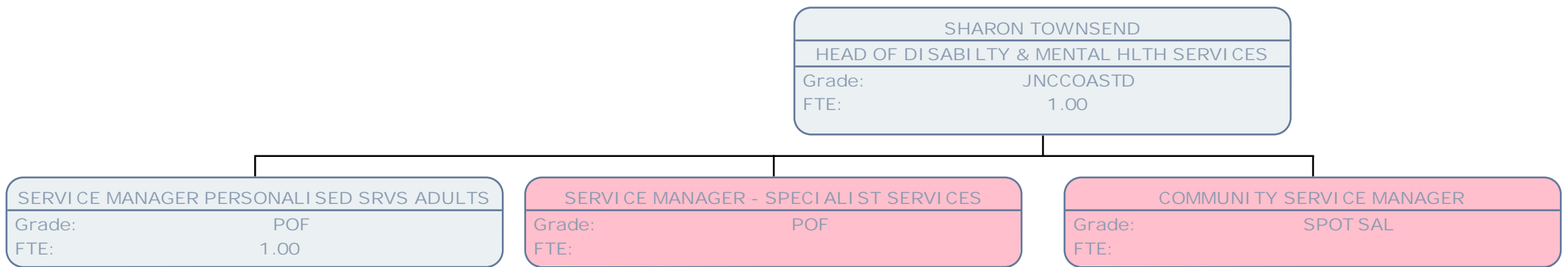

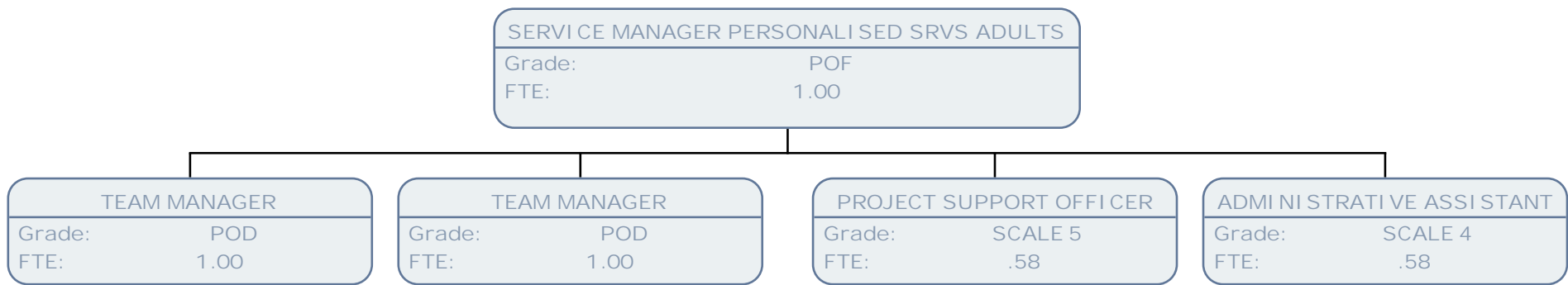

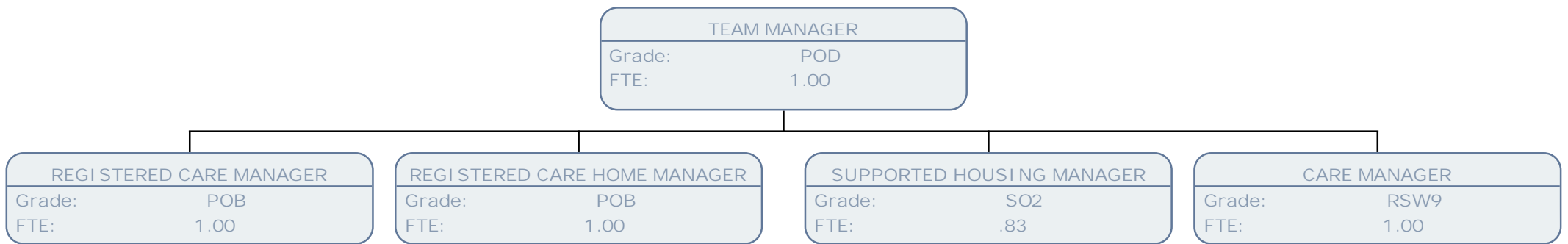



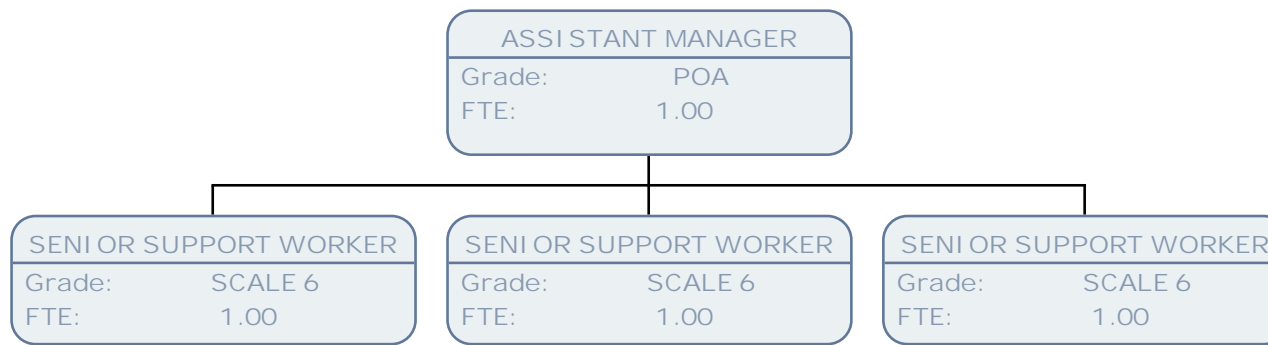

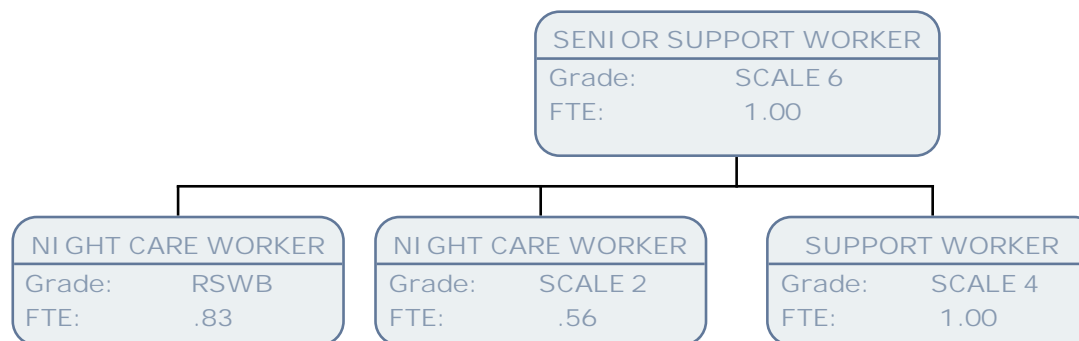

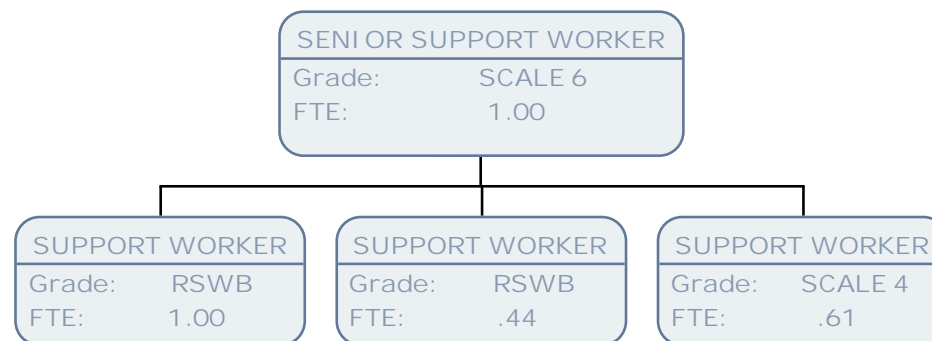

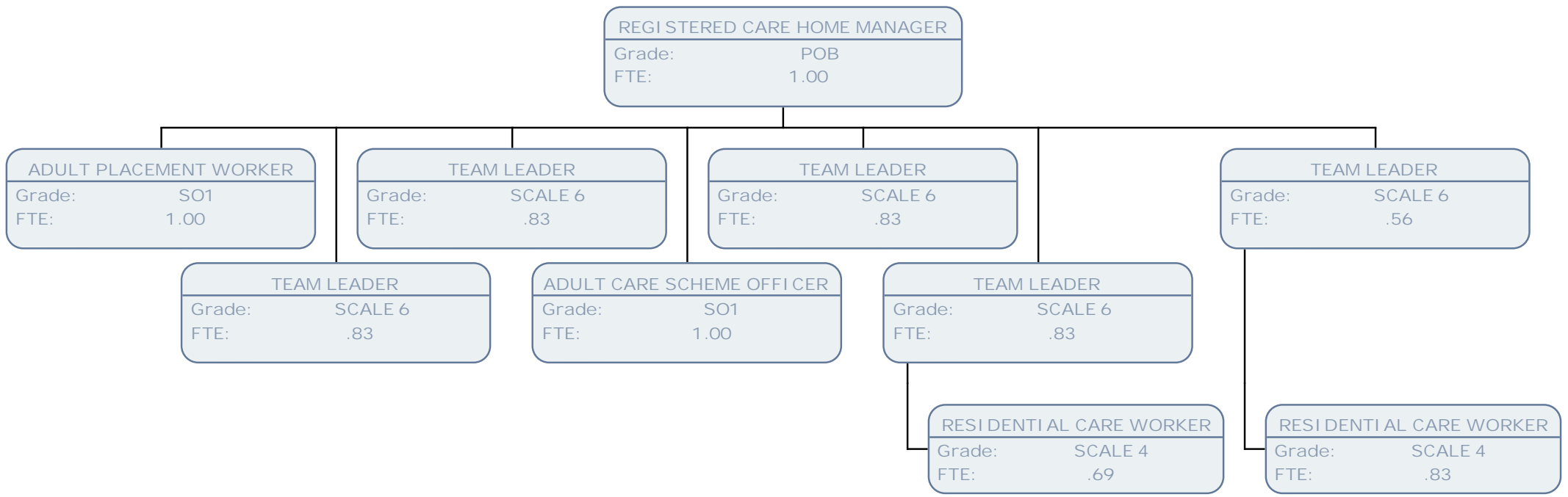

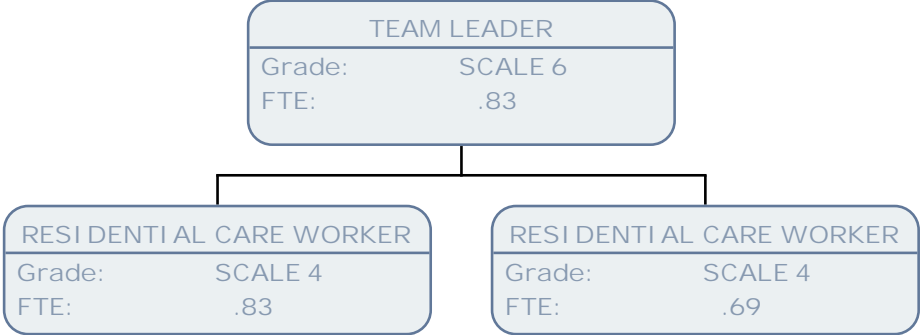

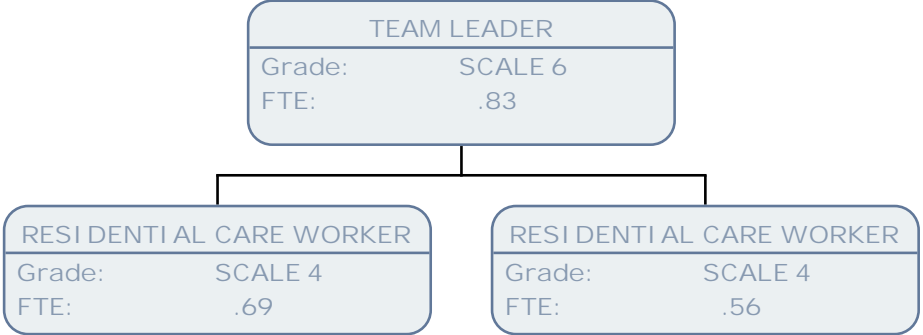

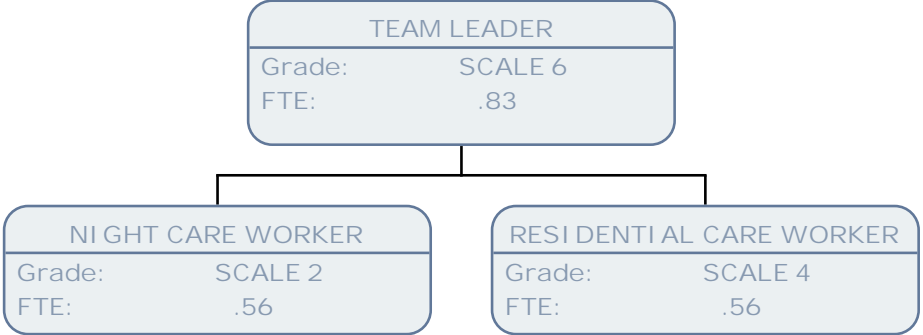

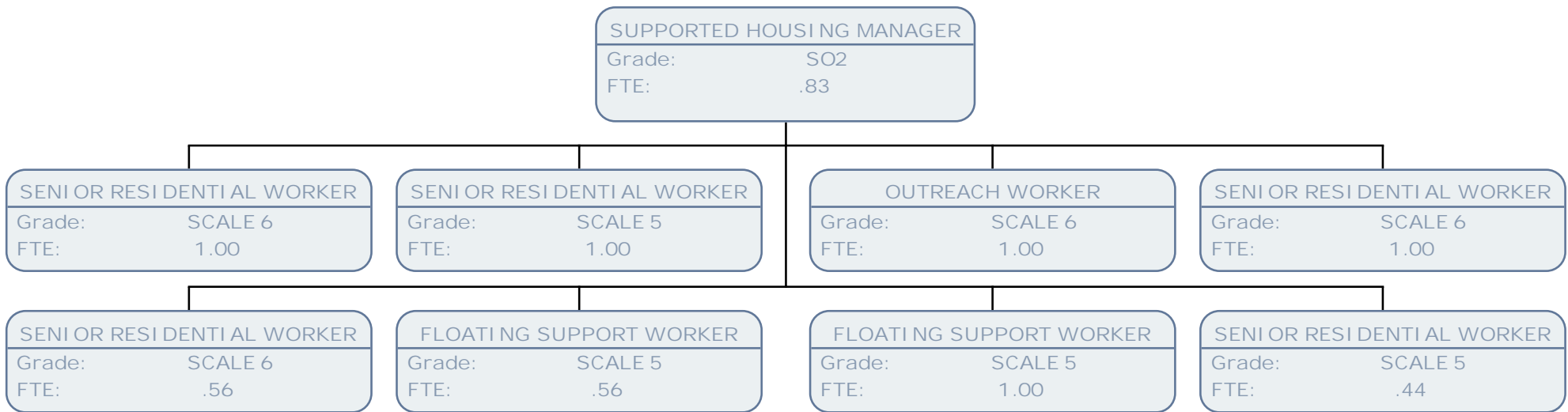

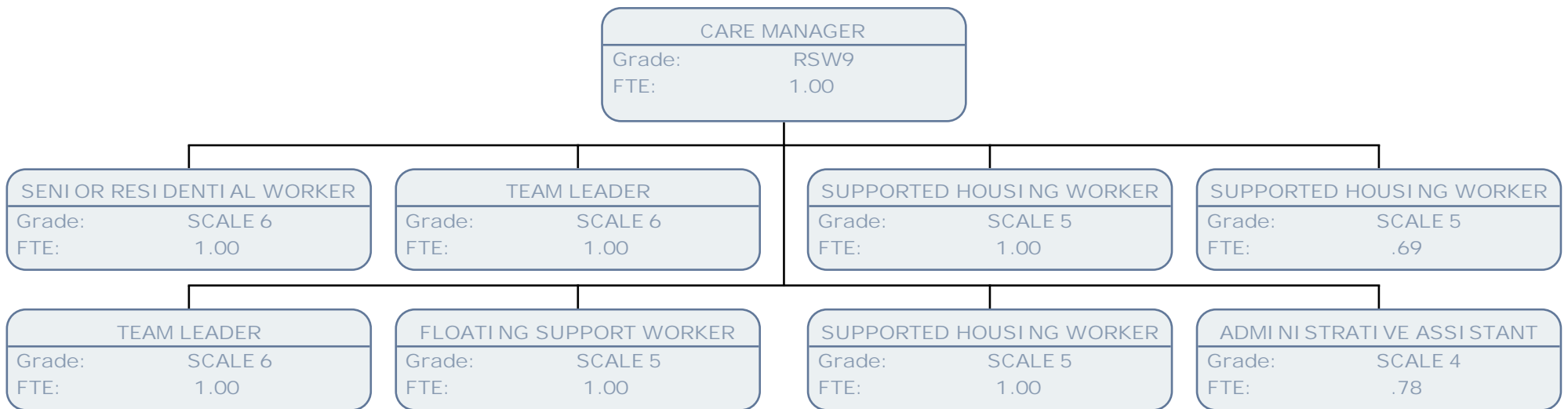

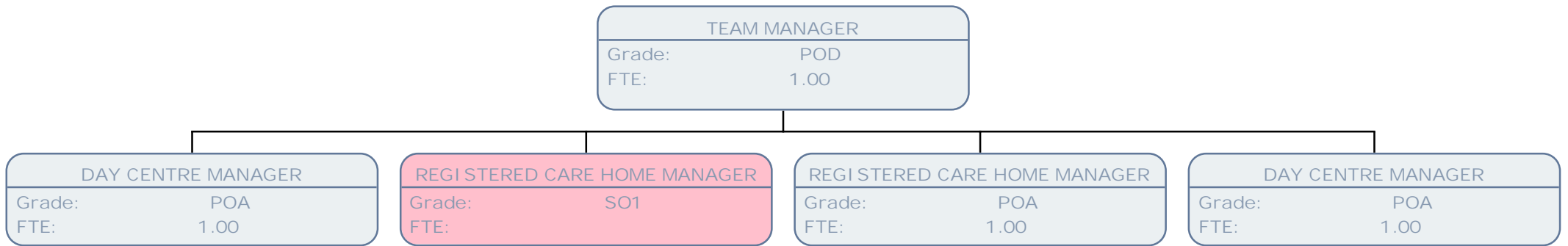

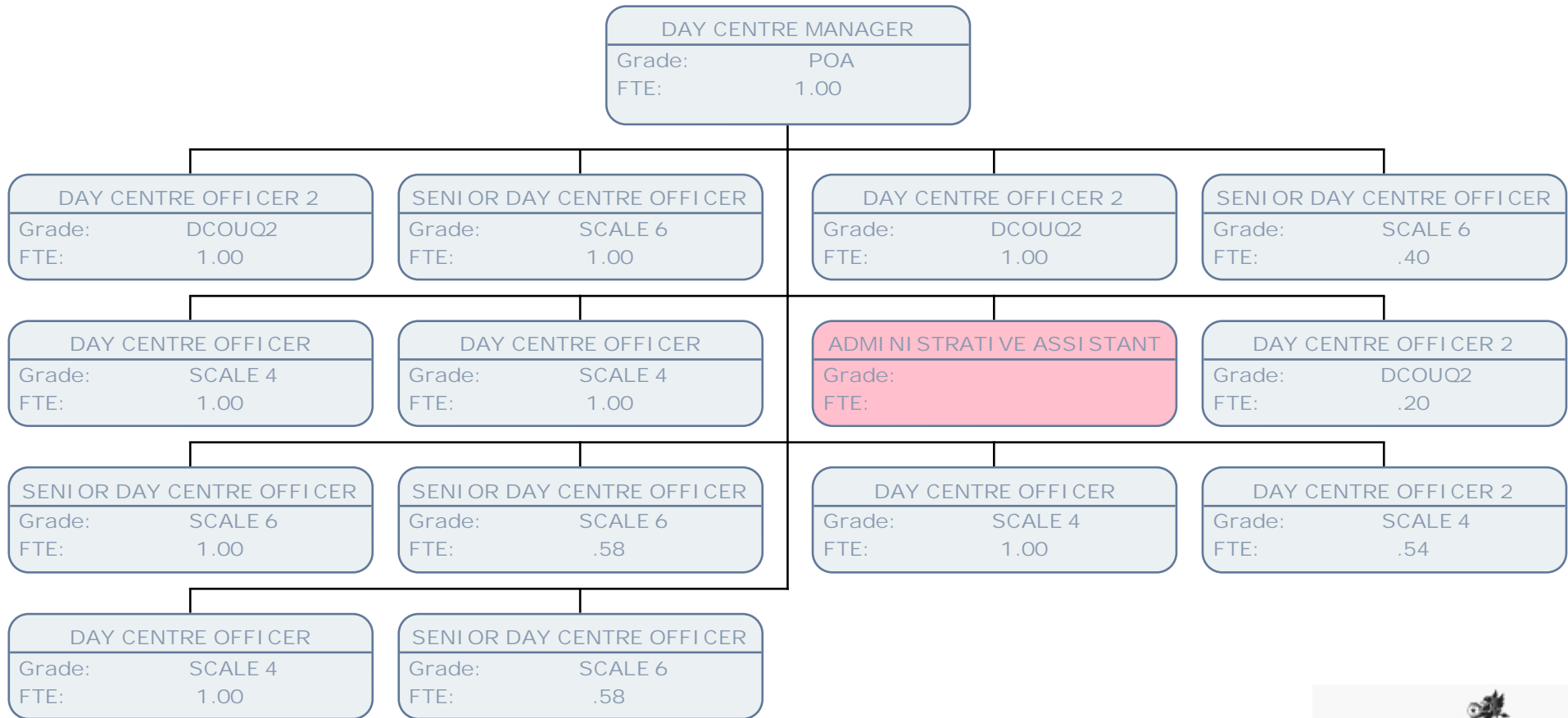

REGISTERED CARE HOME MANAGER
 Grade: SO1
 FTE:

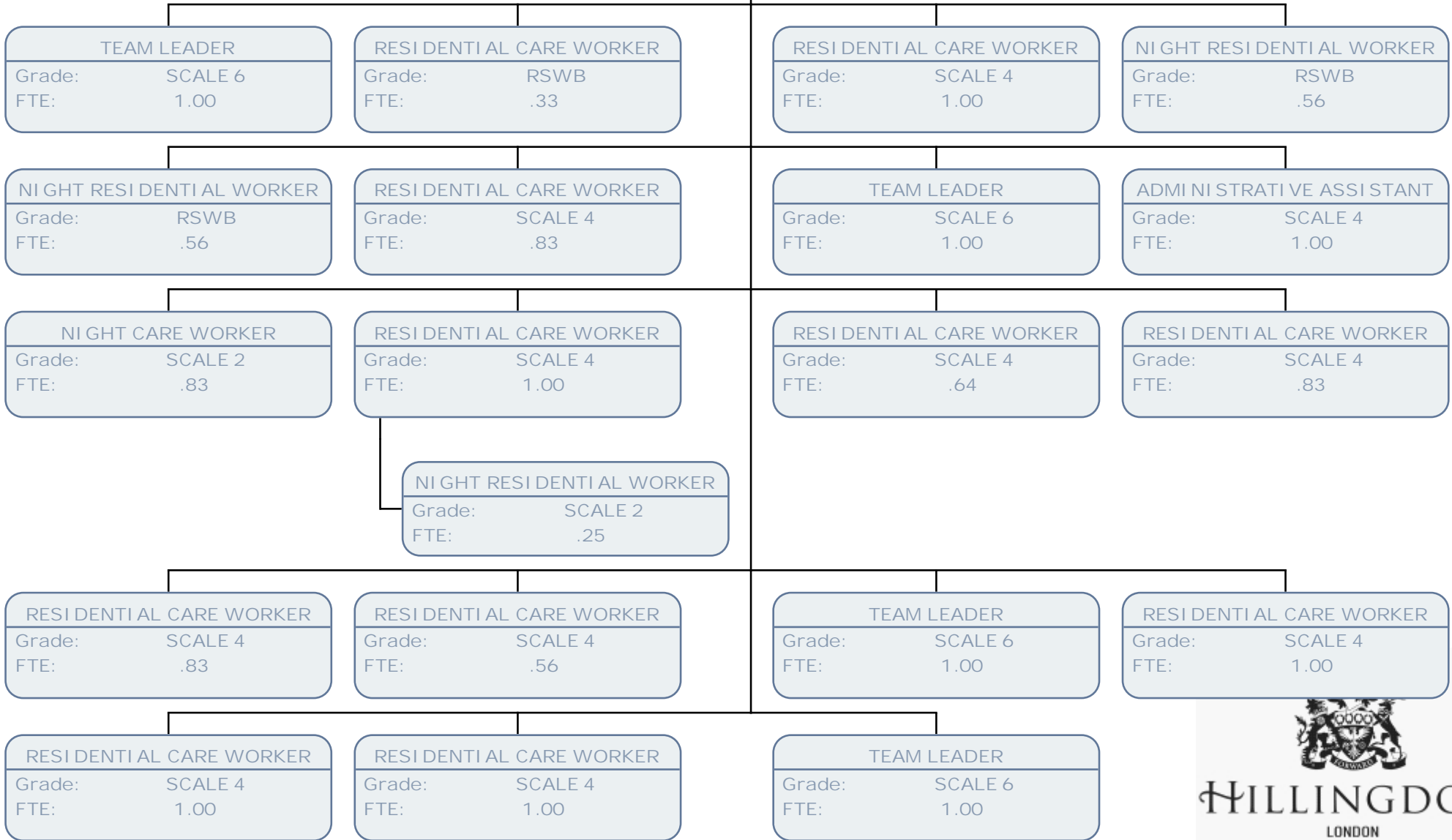

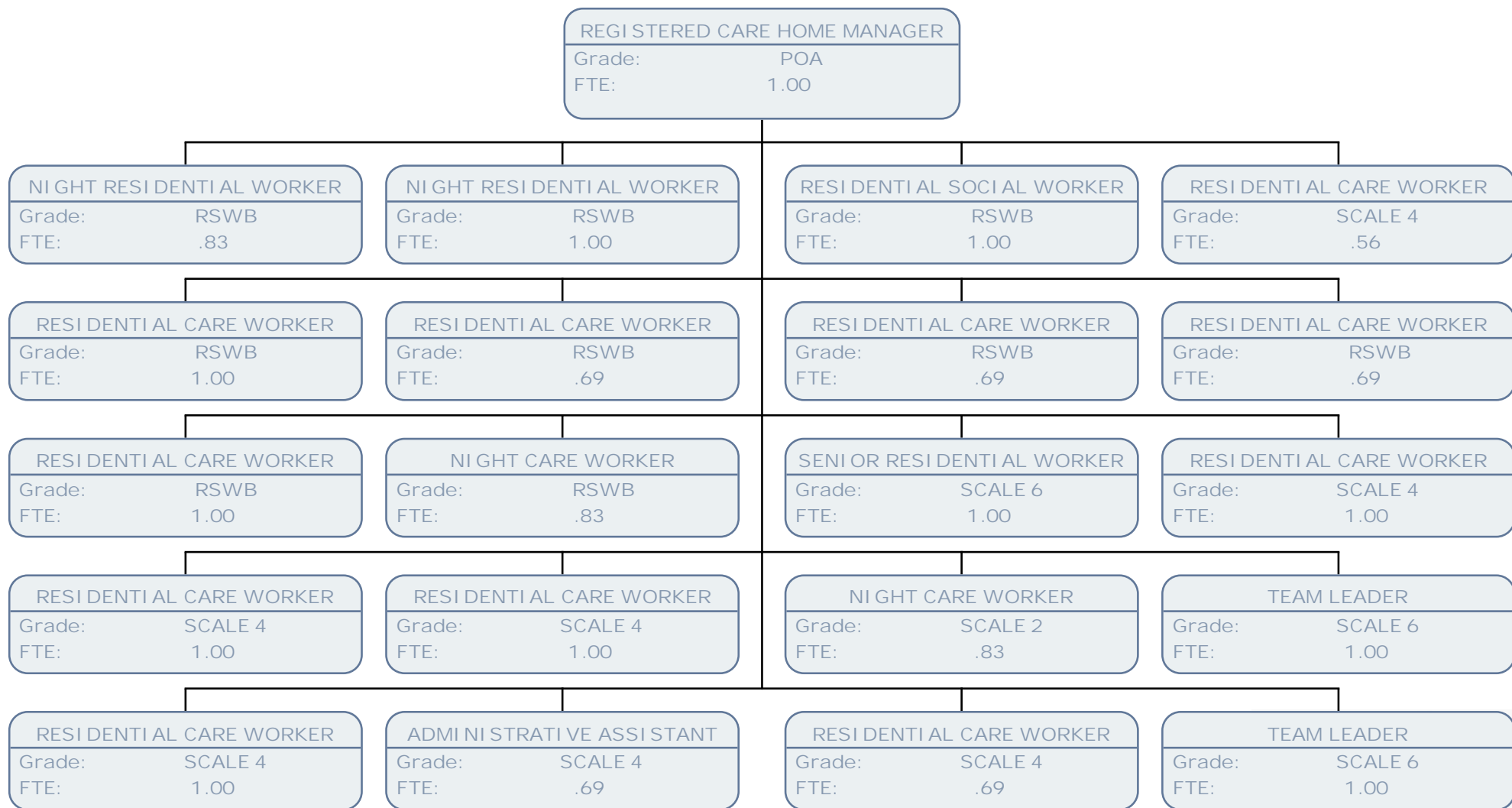

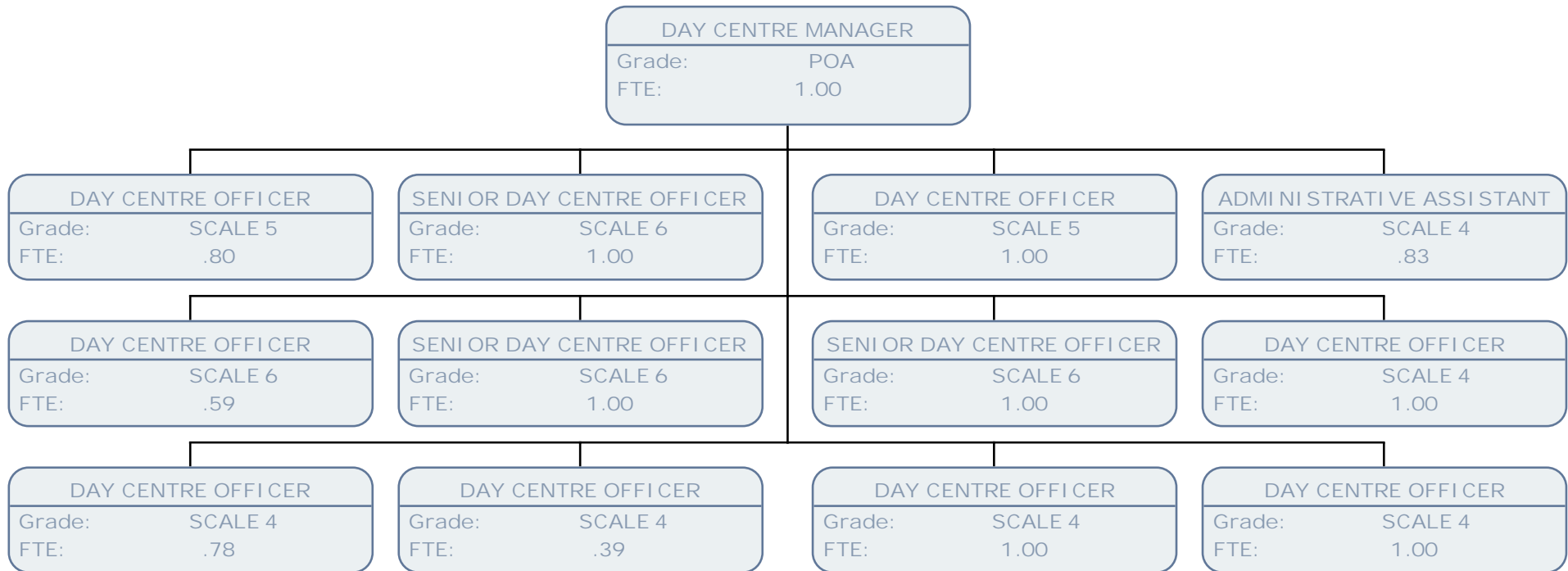

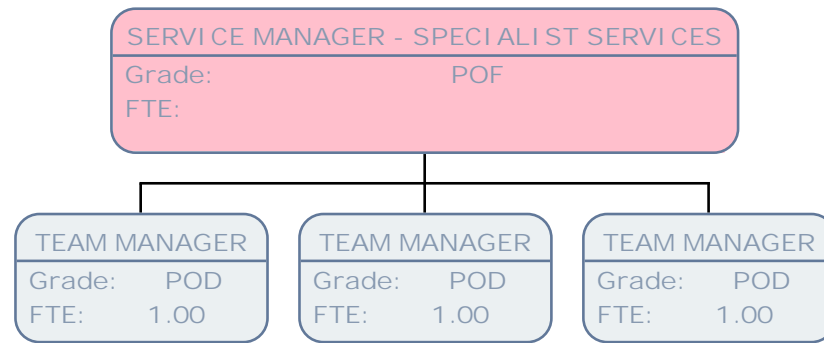

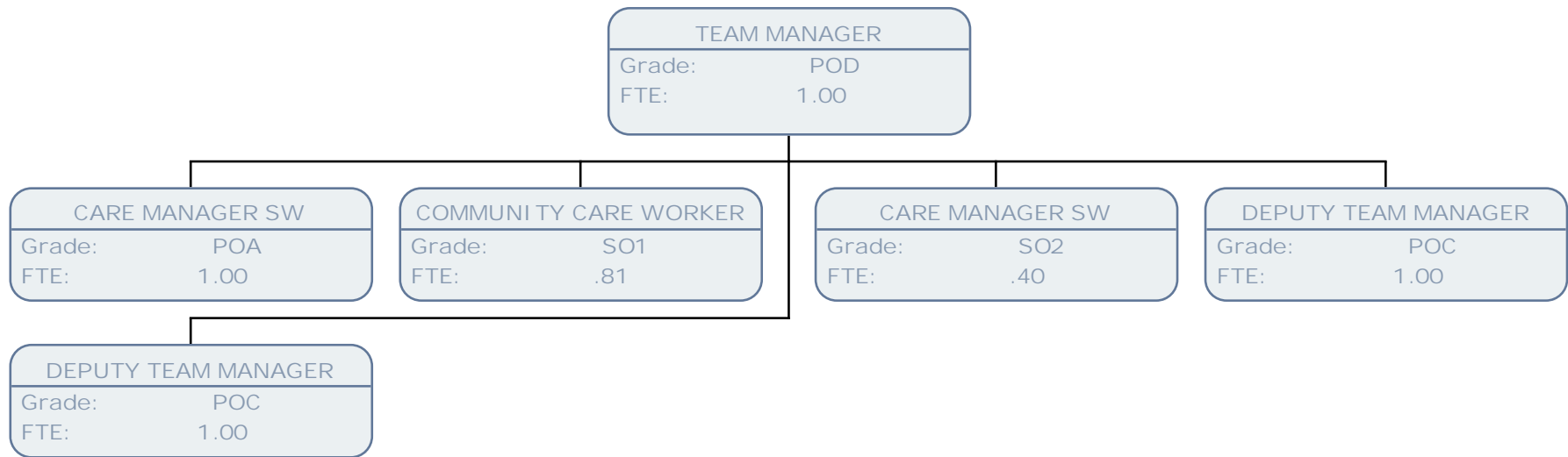

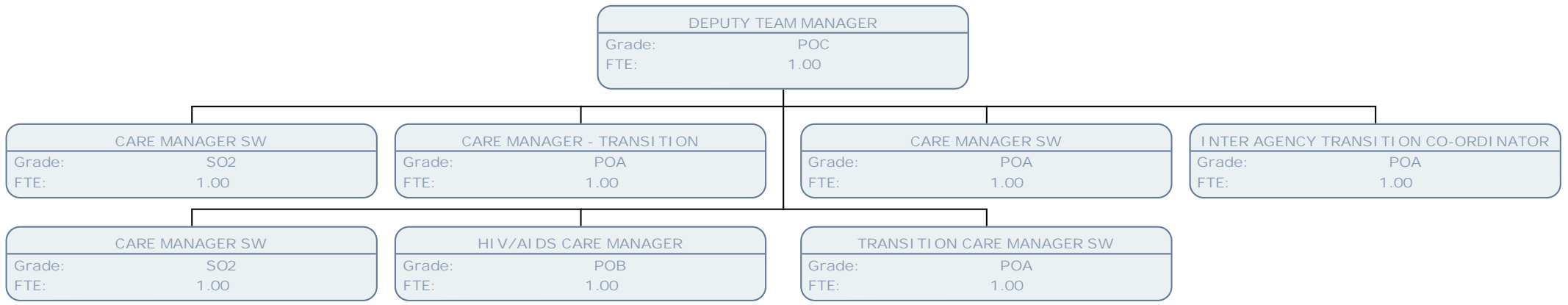

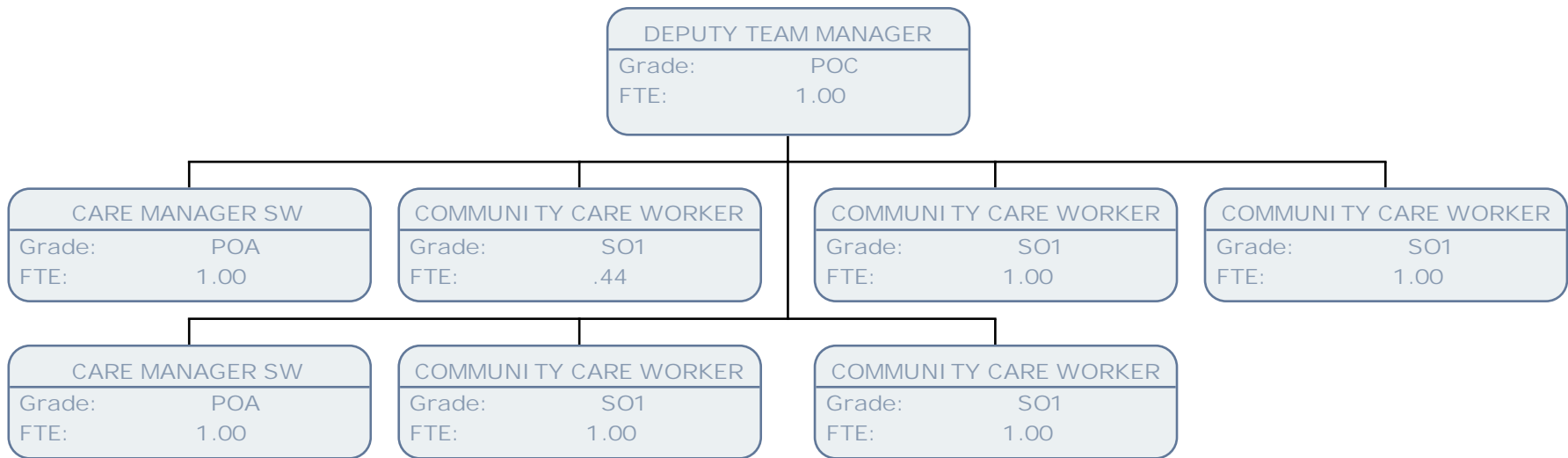

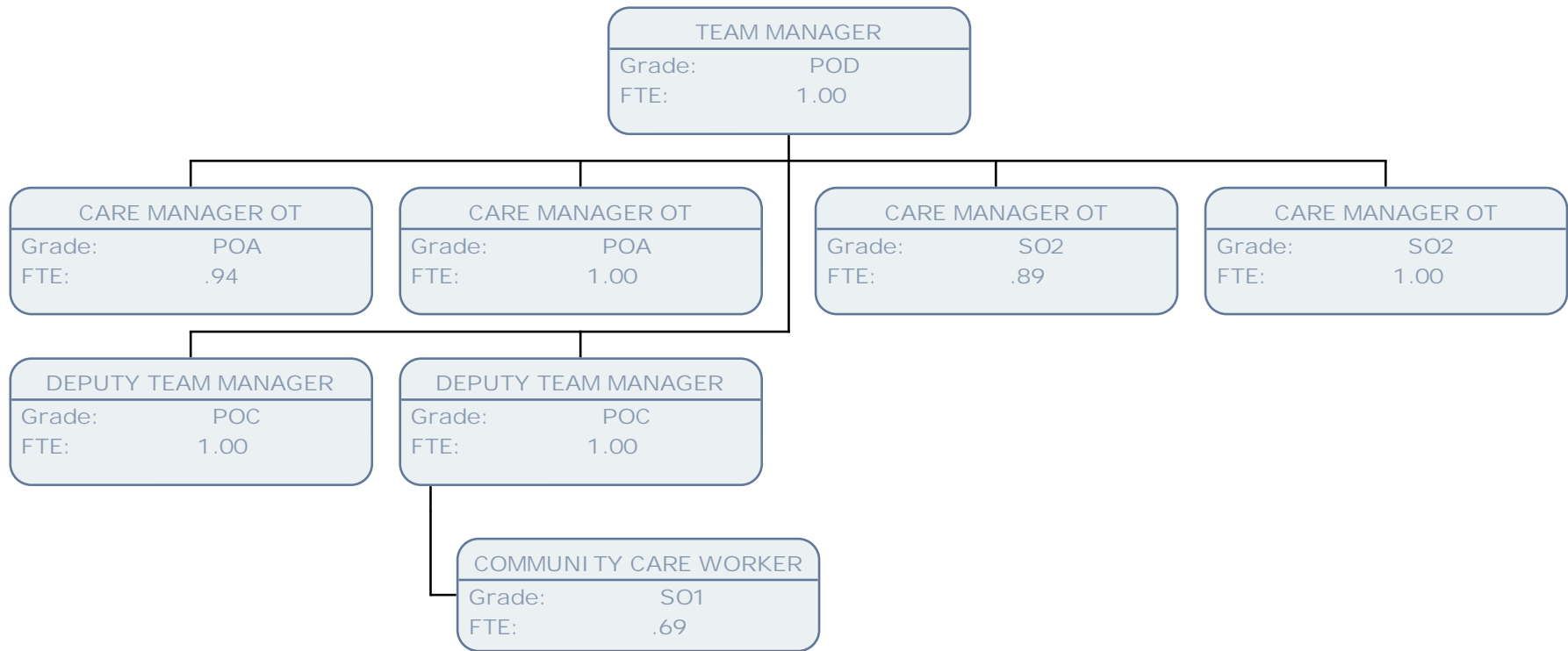

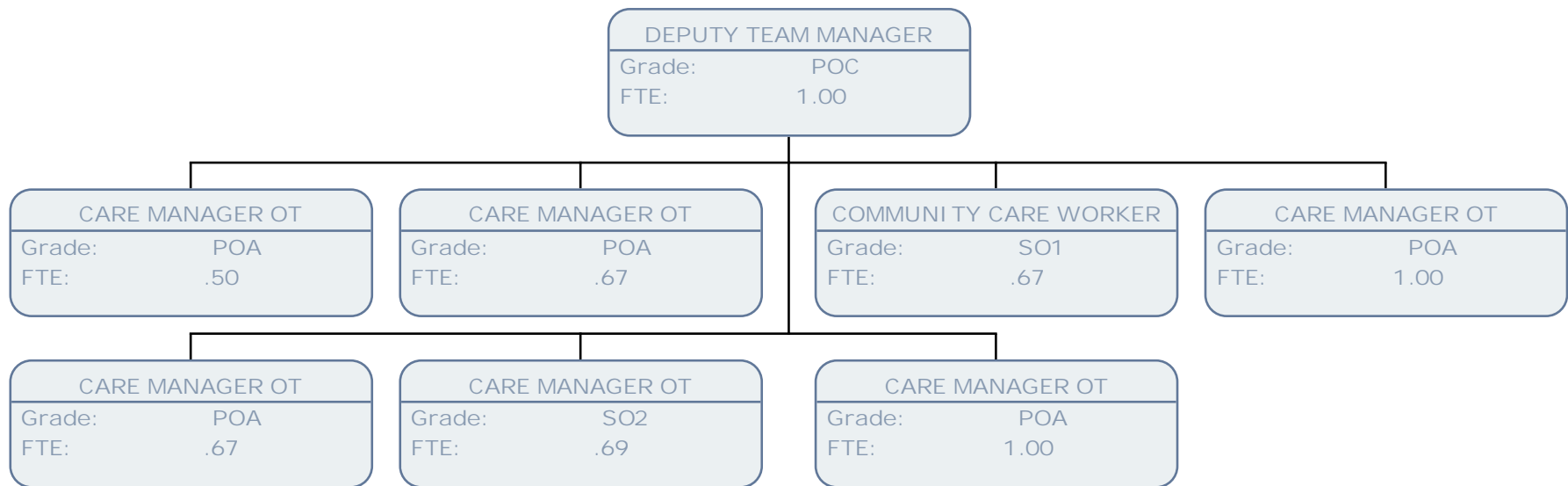

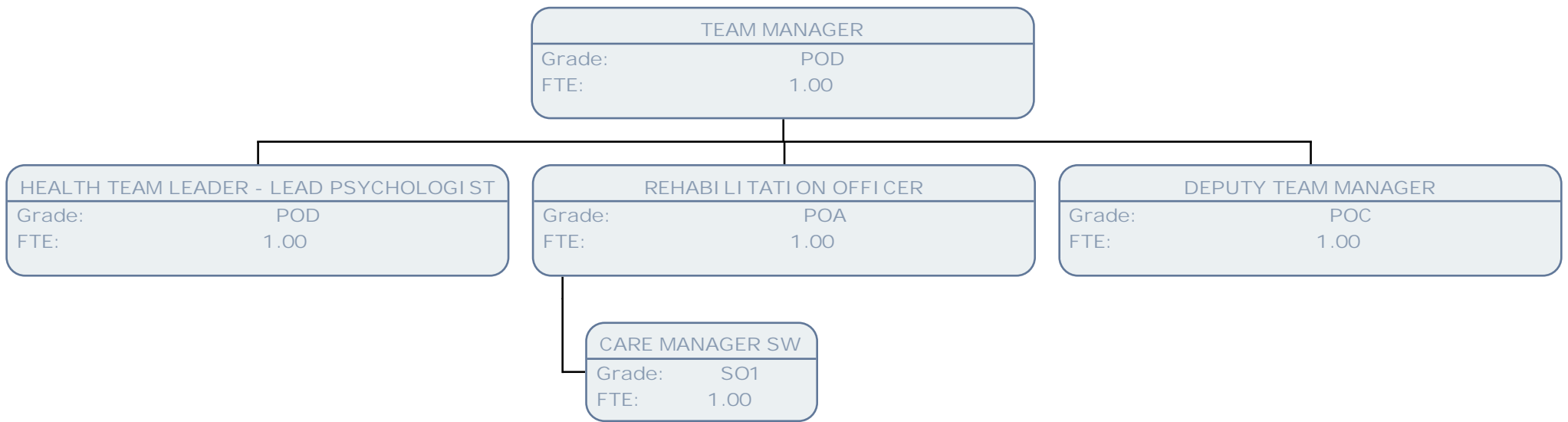

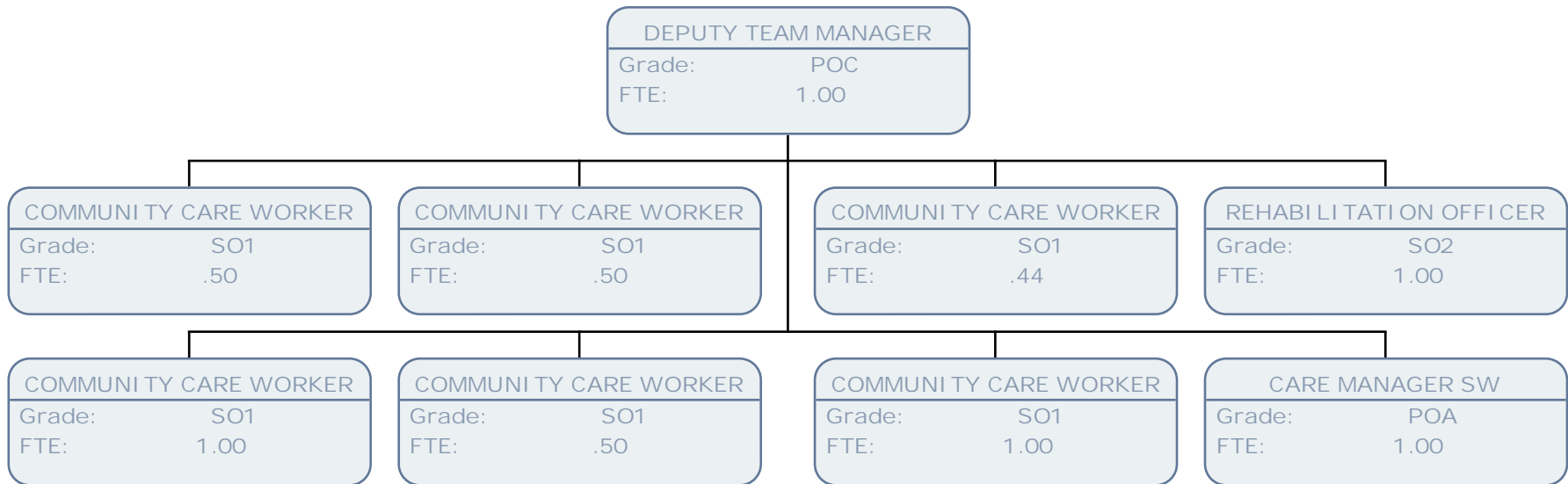

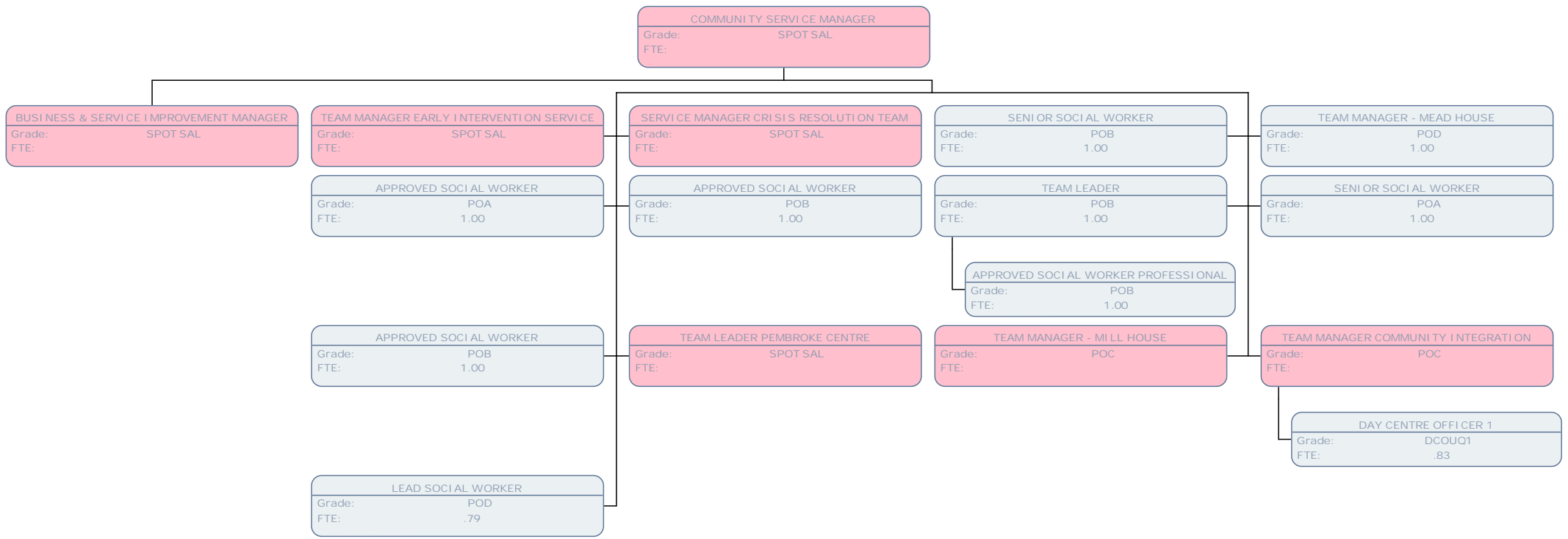

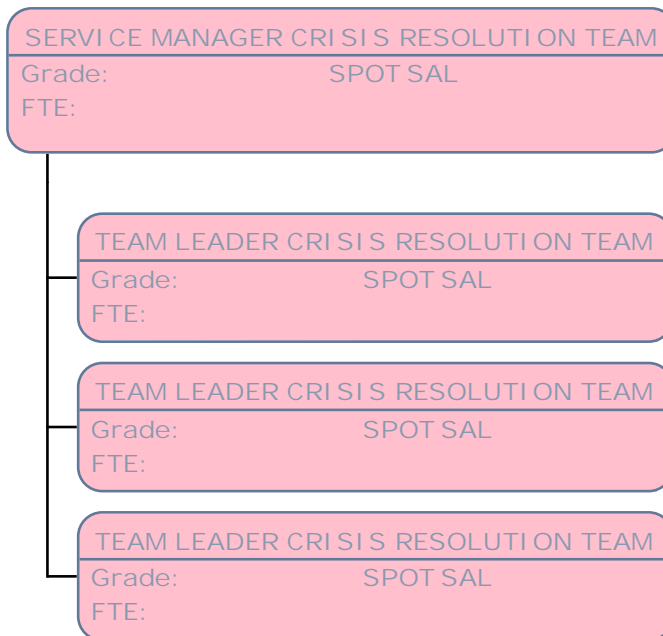

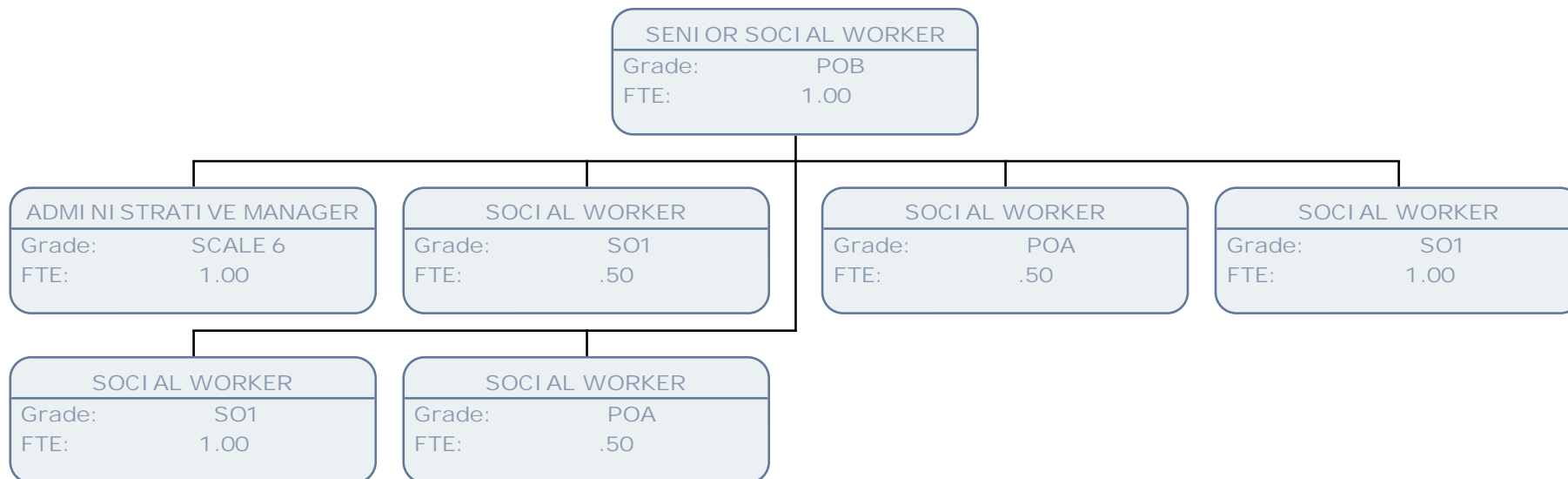

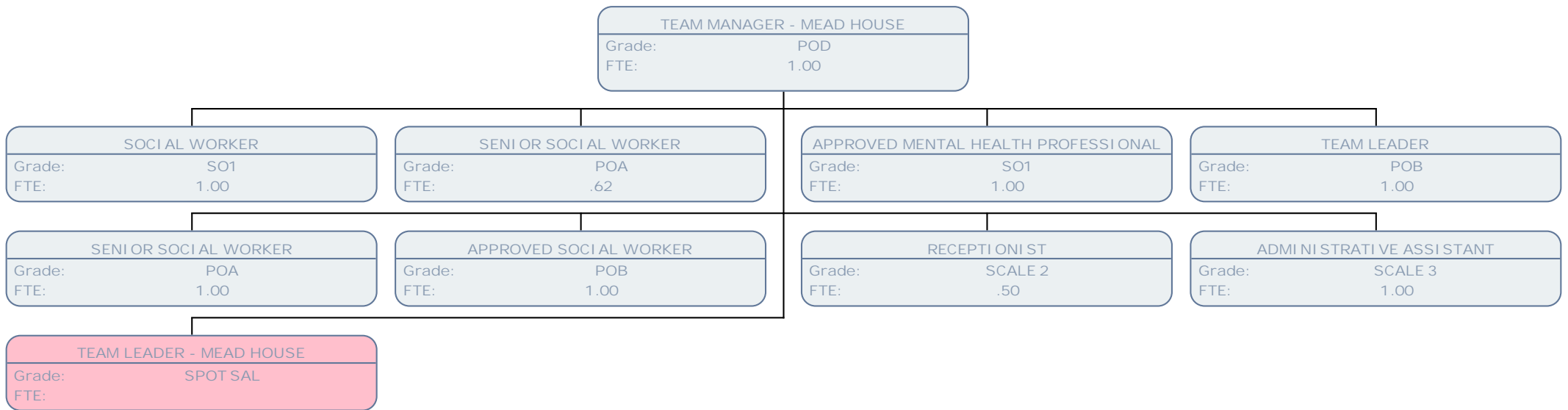

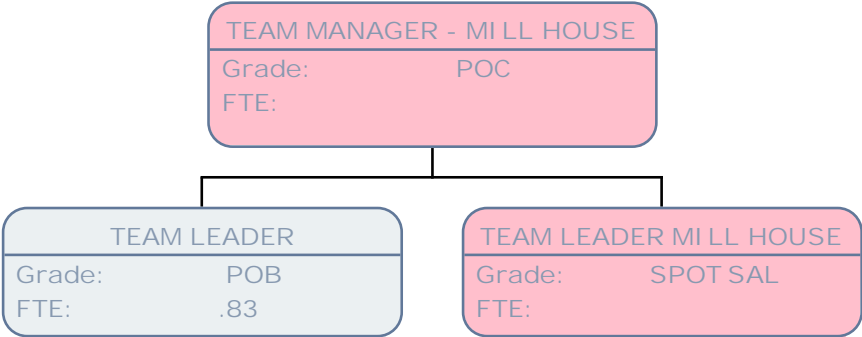

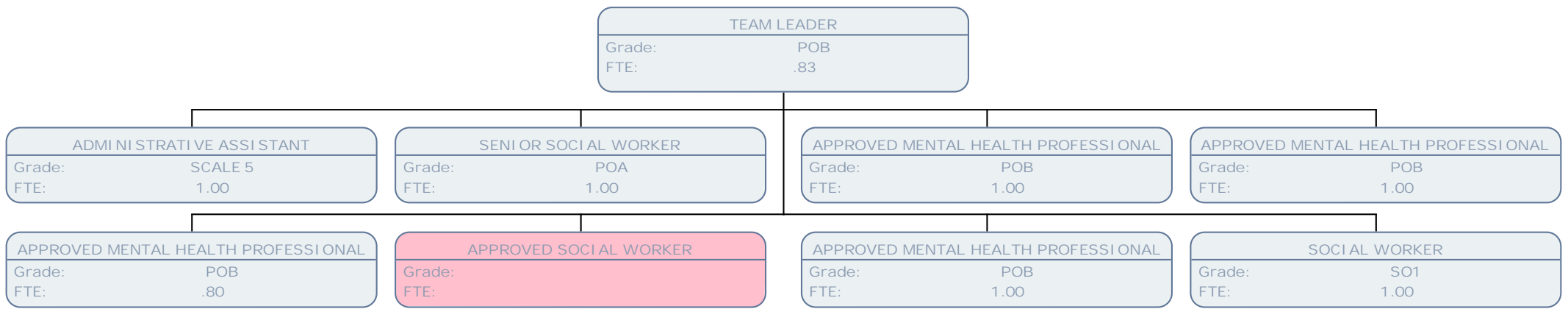

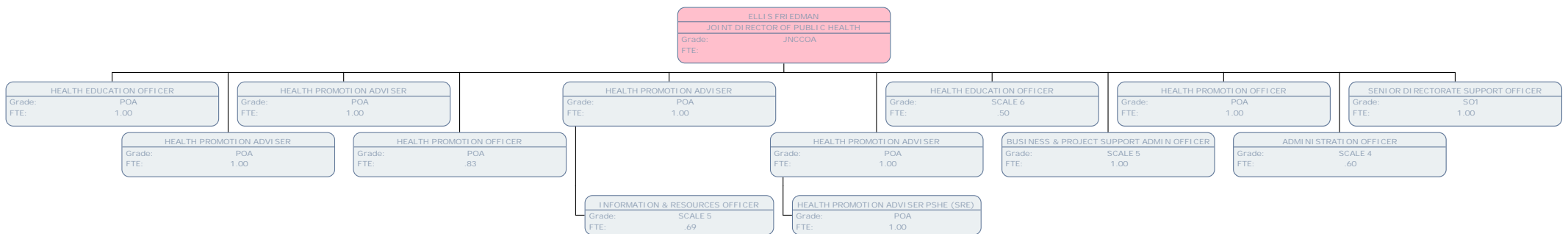

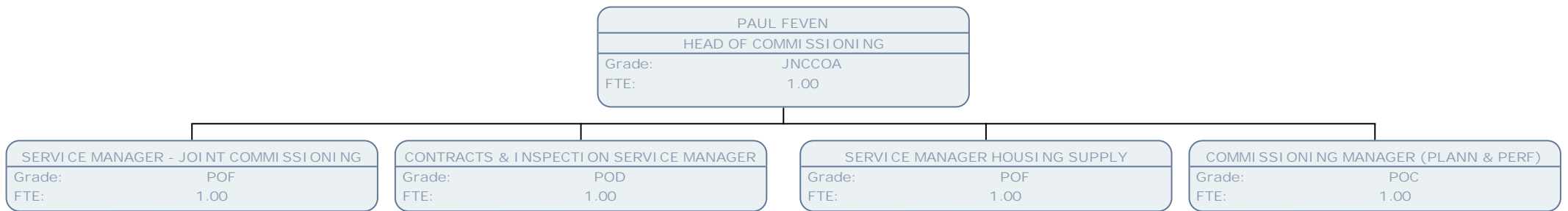

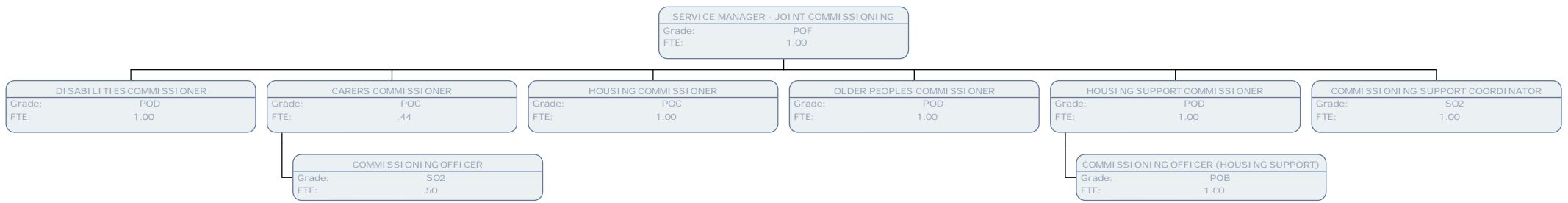

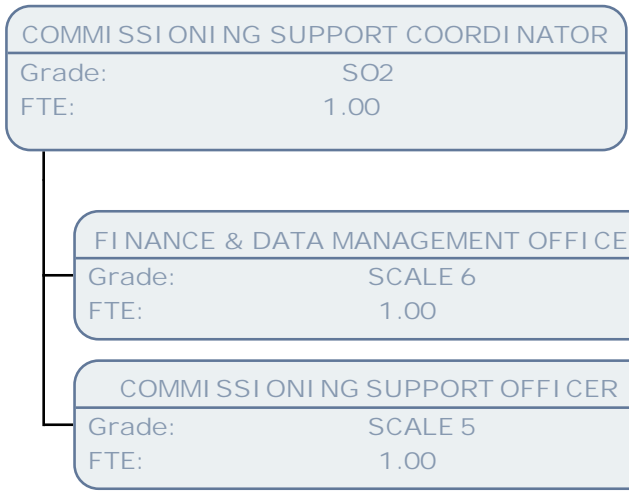

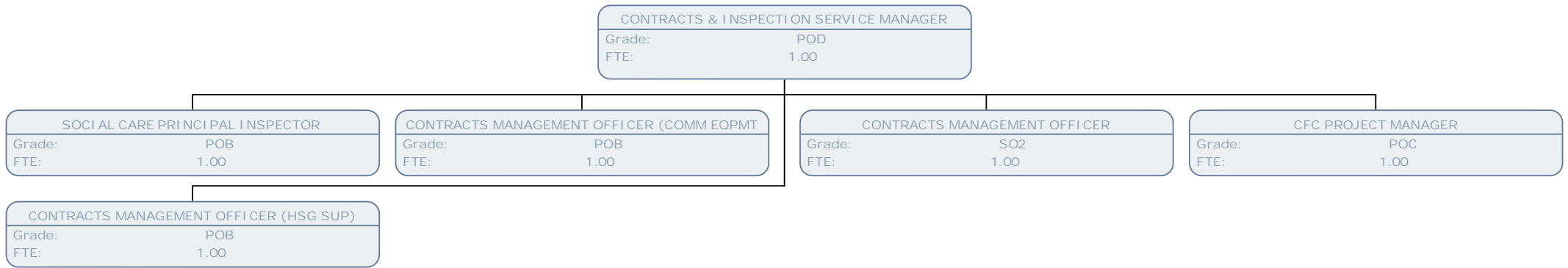

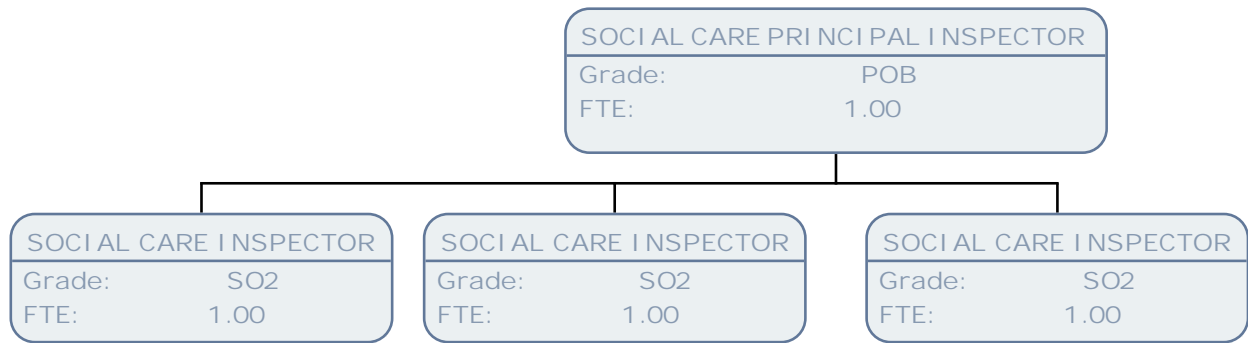

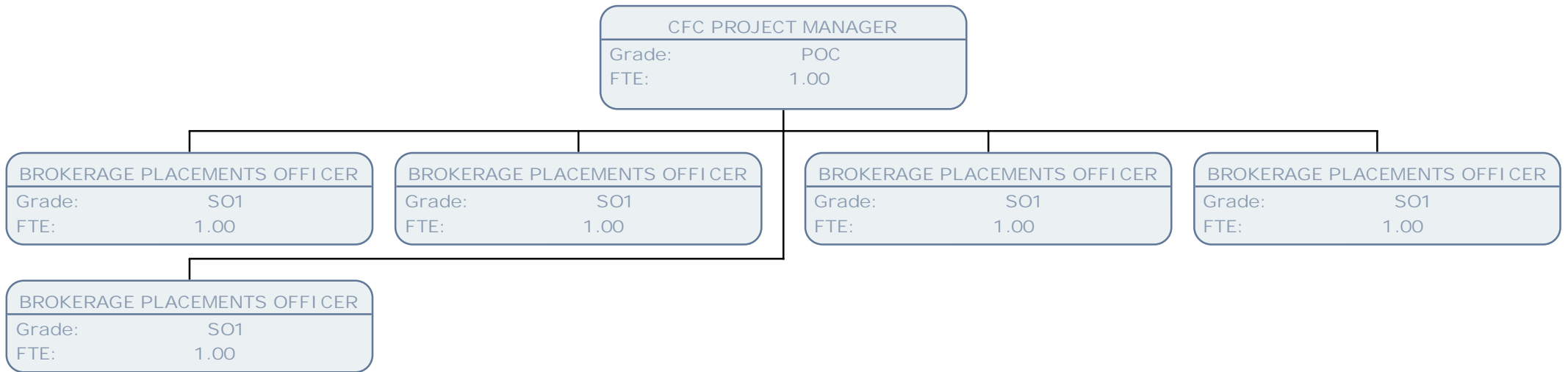

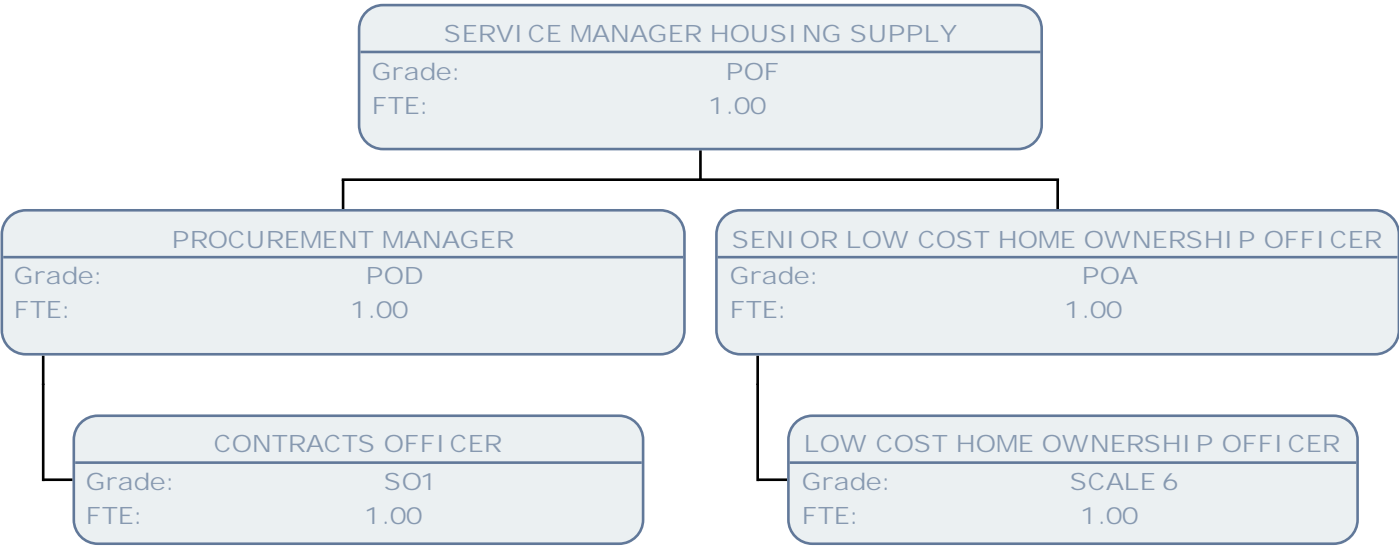

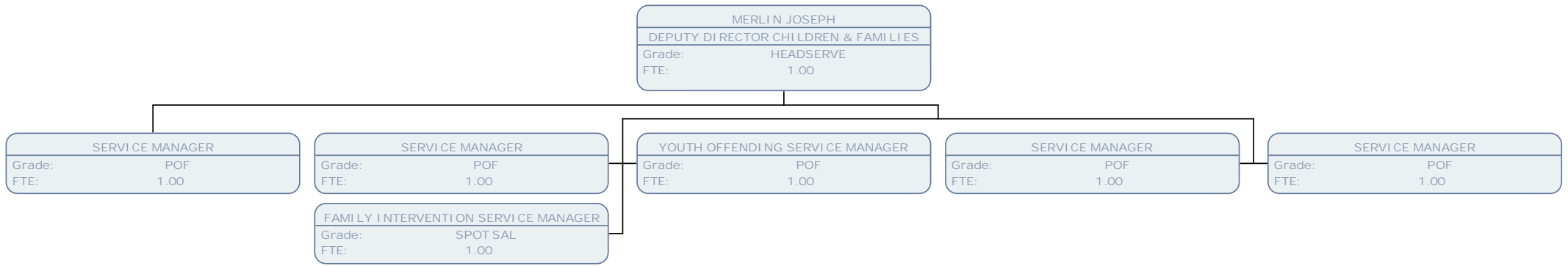

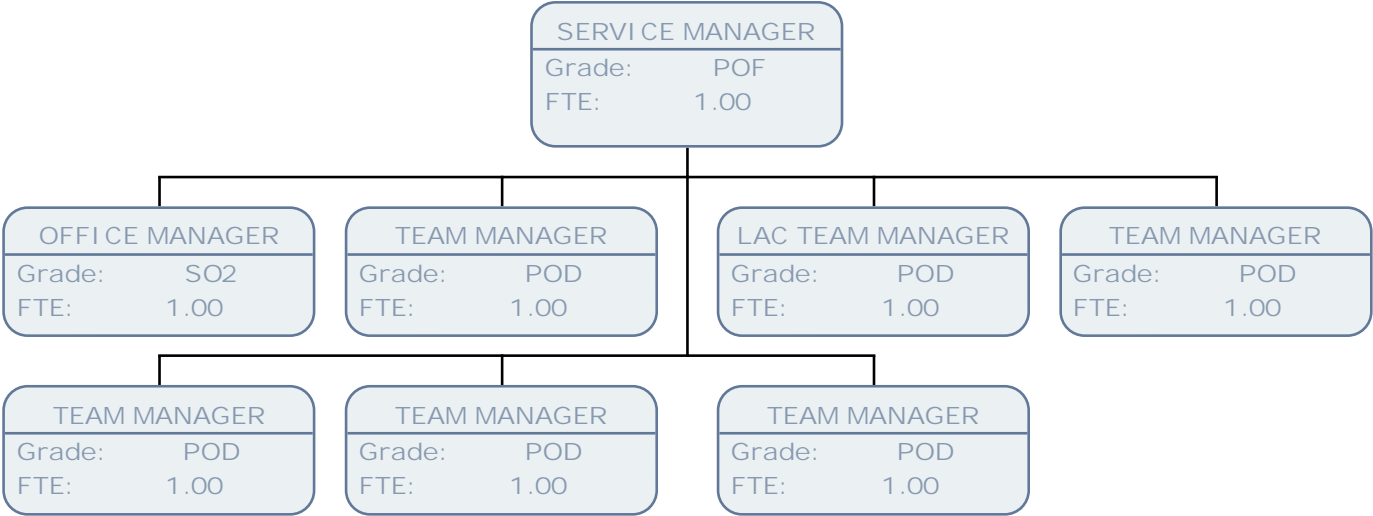

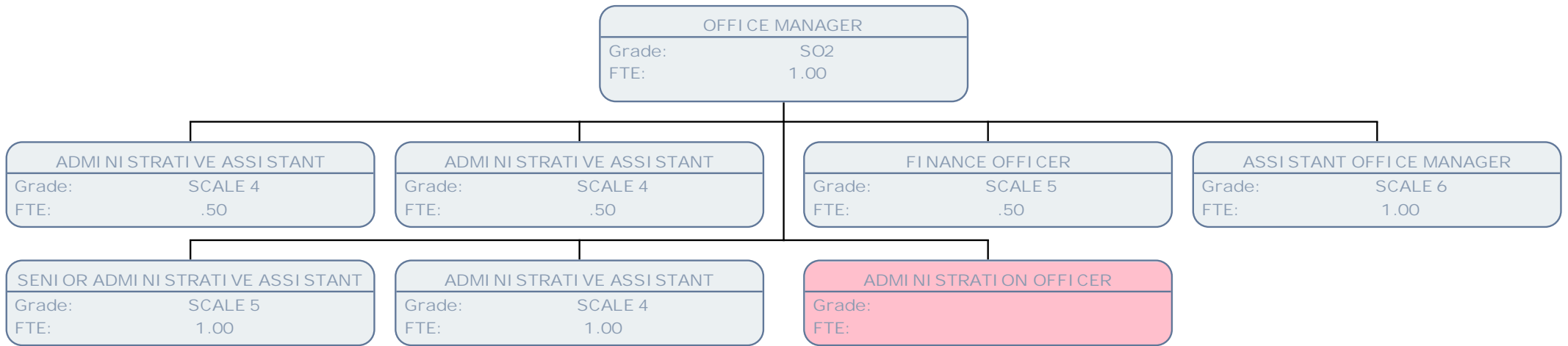

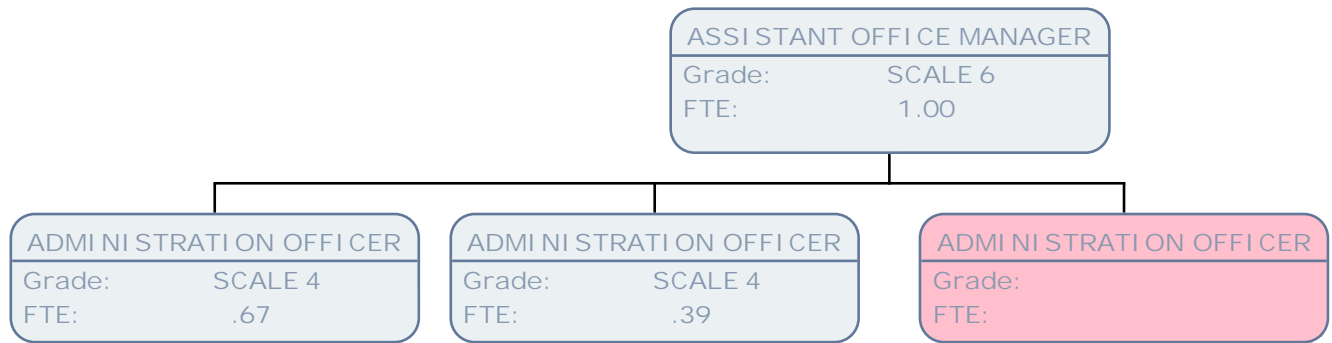

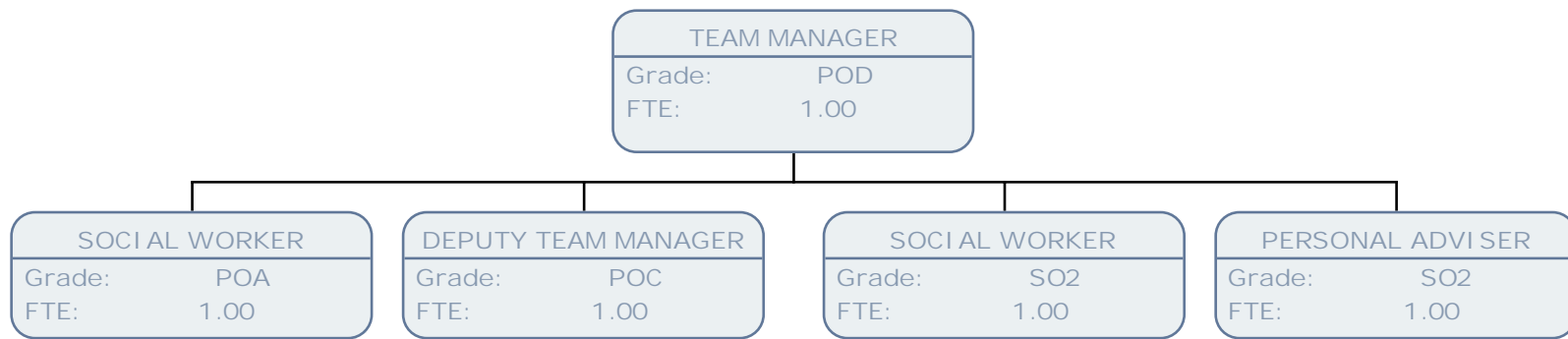

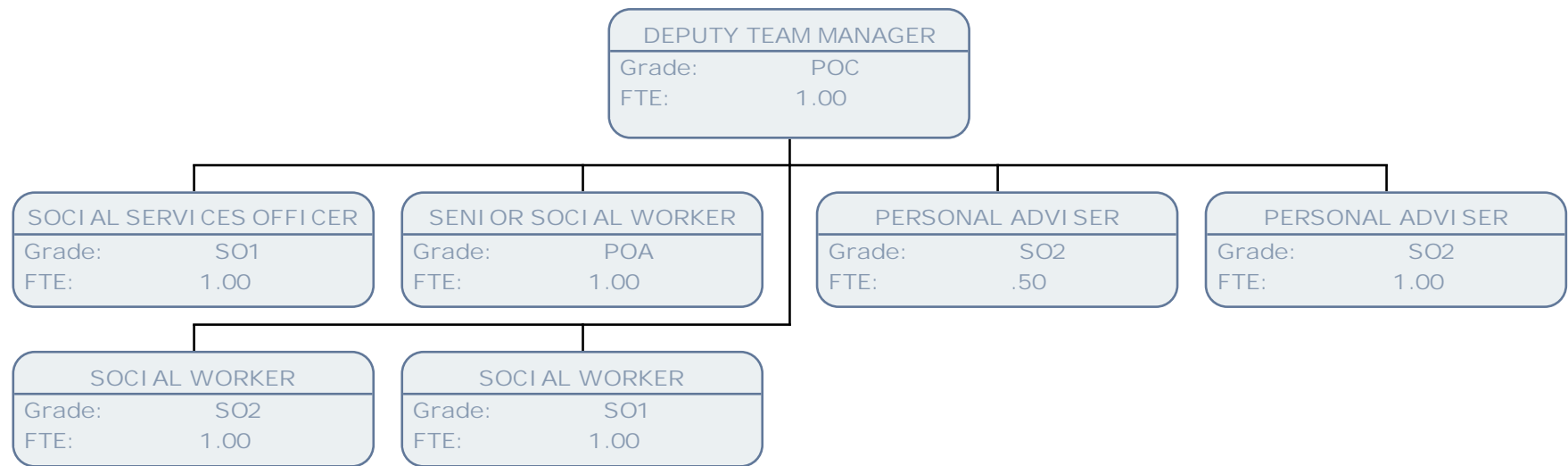

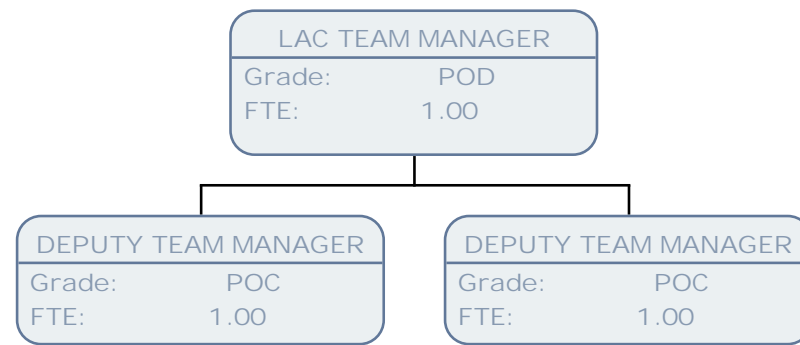

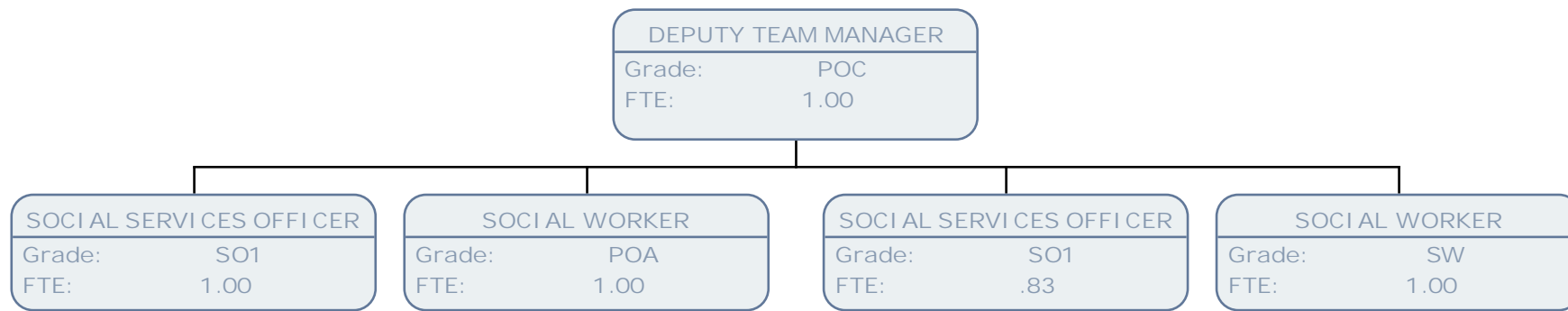

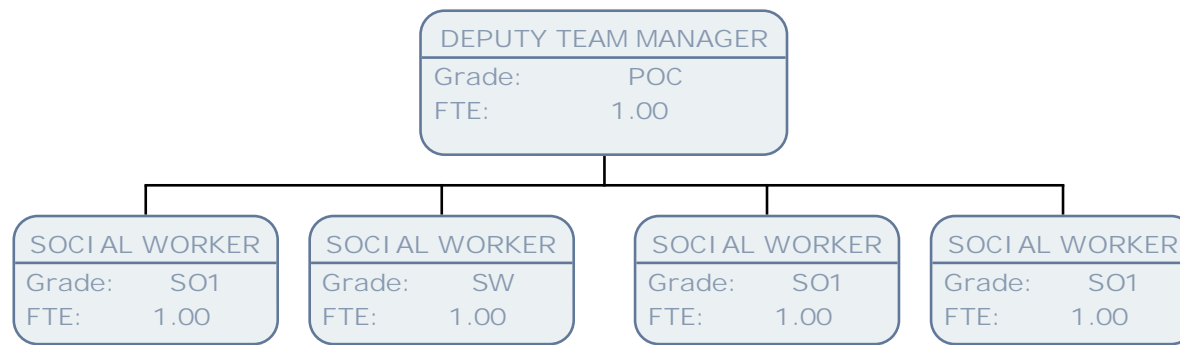

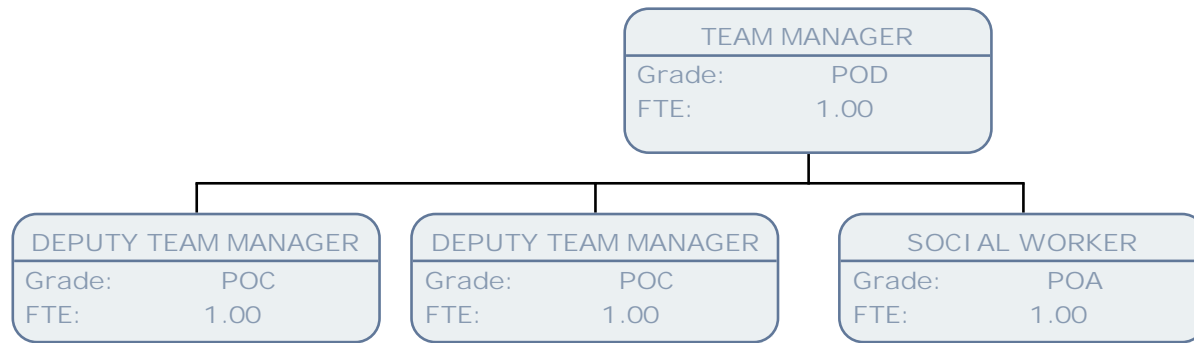

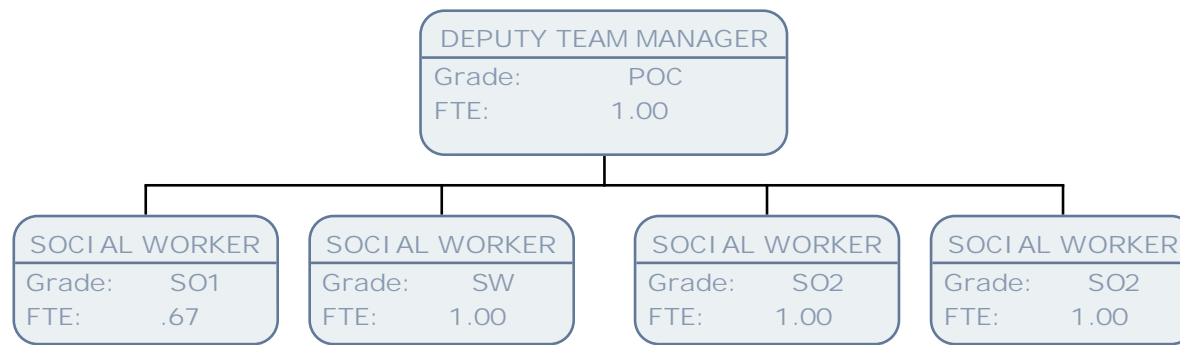

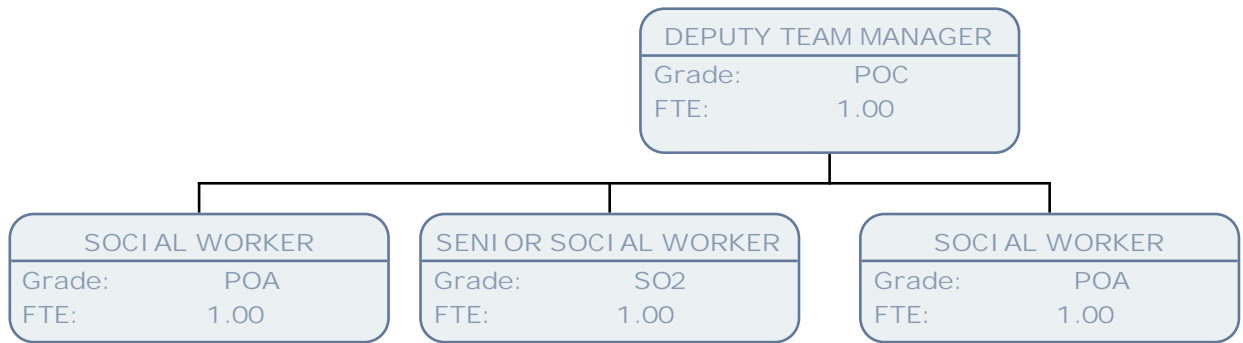

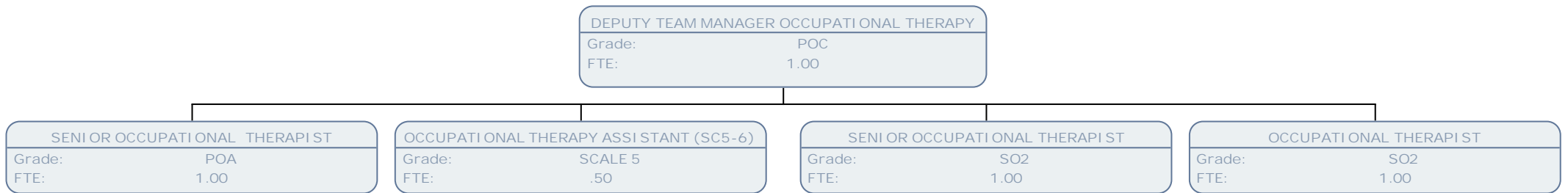

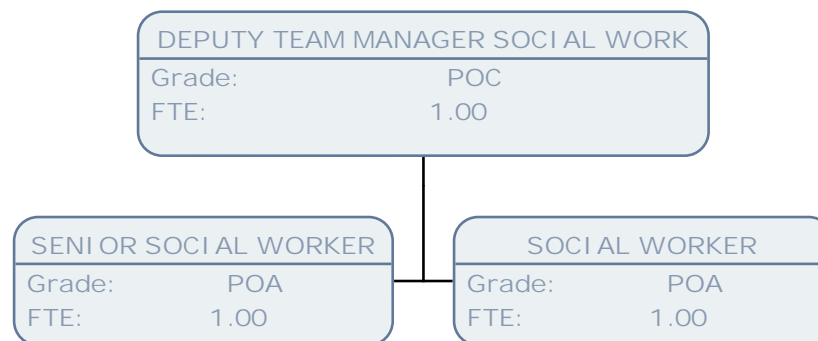

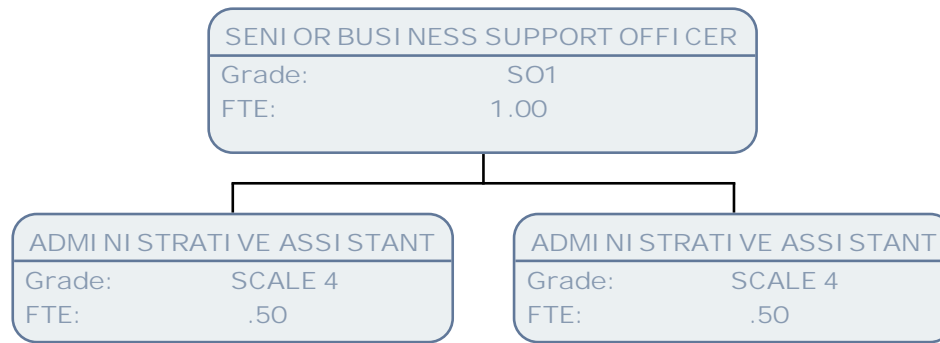

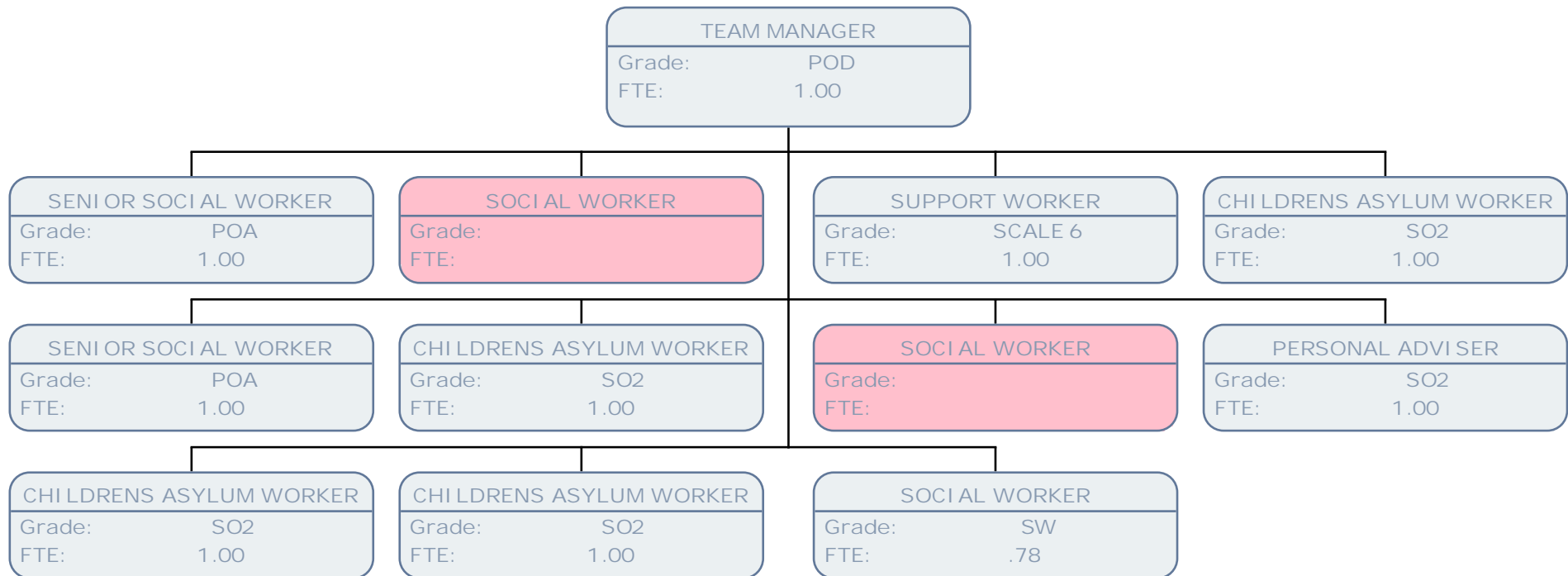

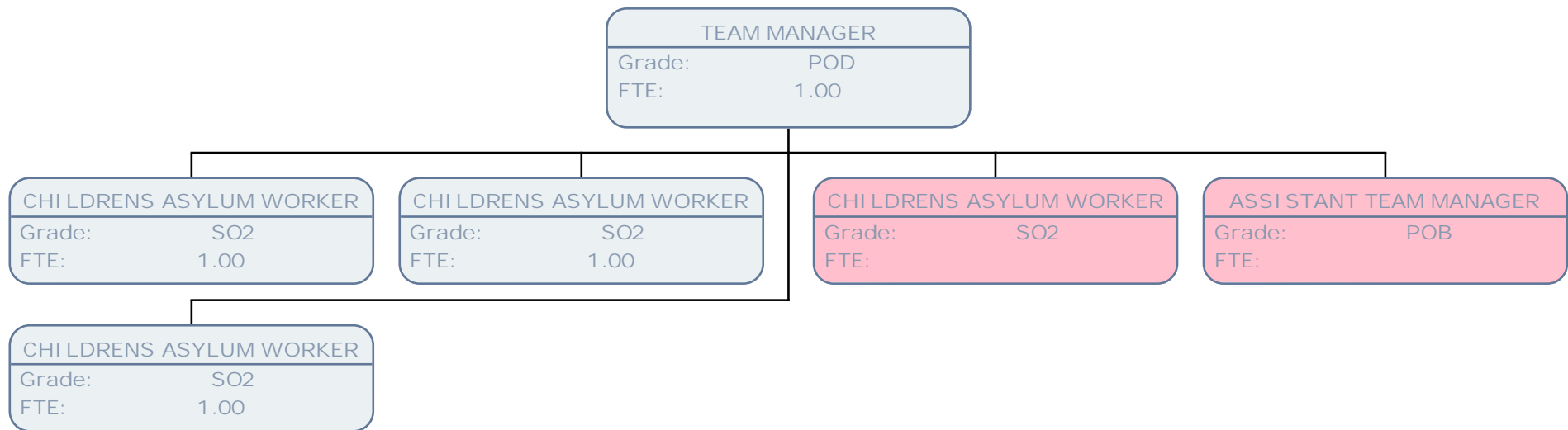

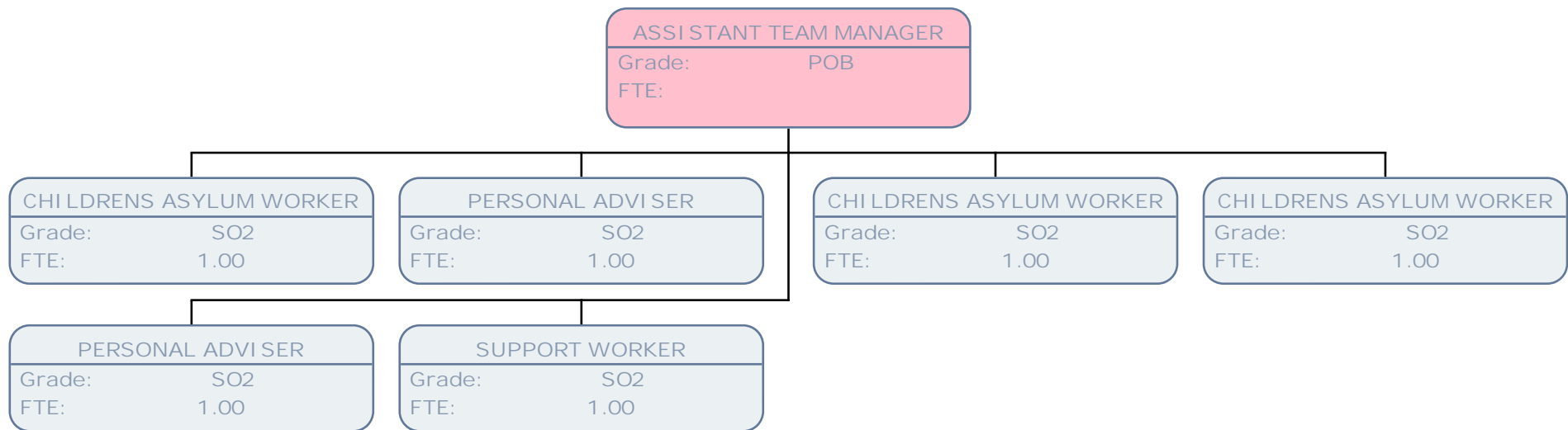

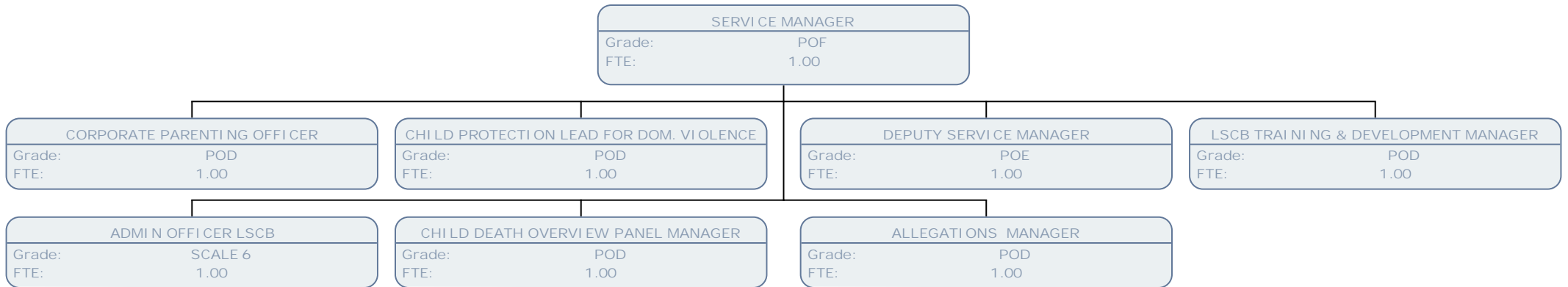

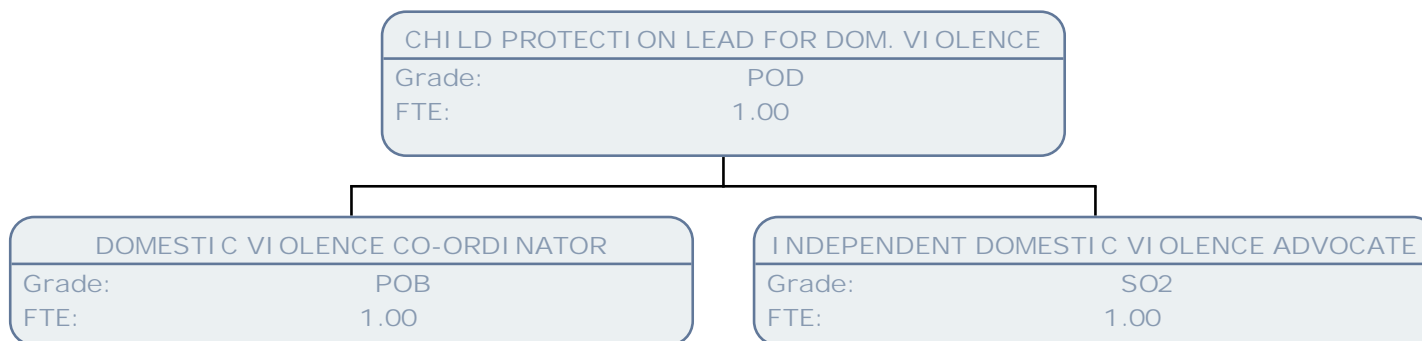

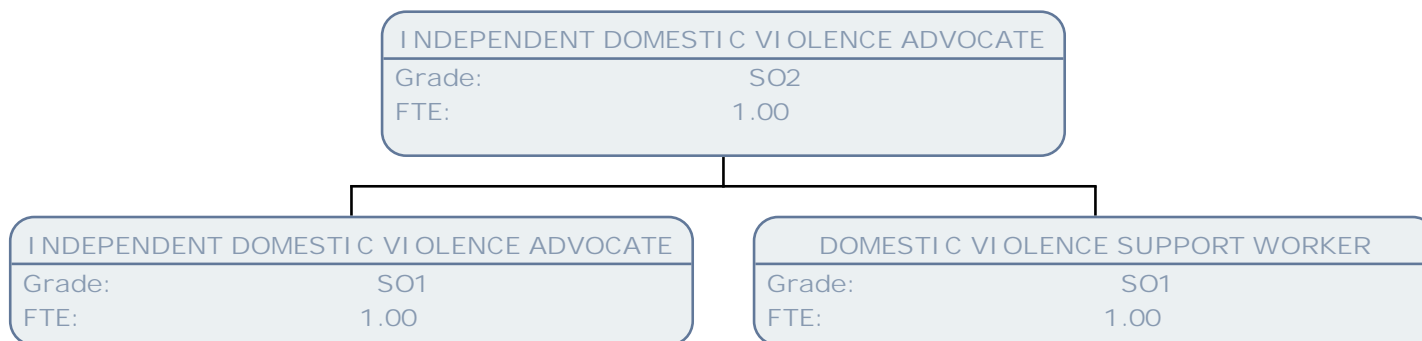

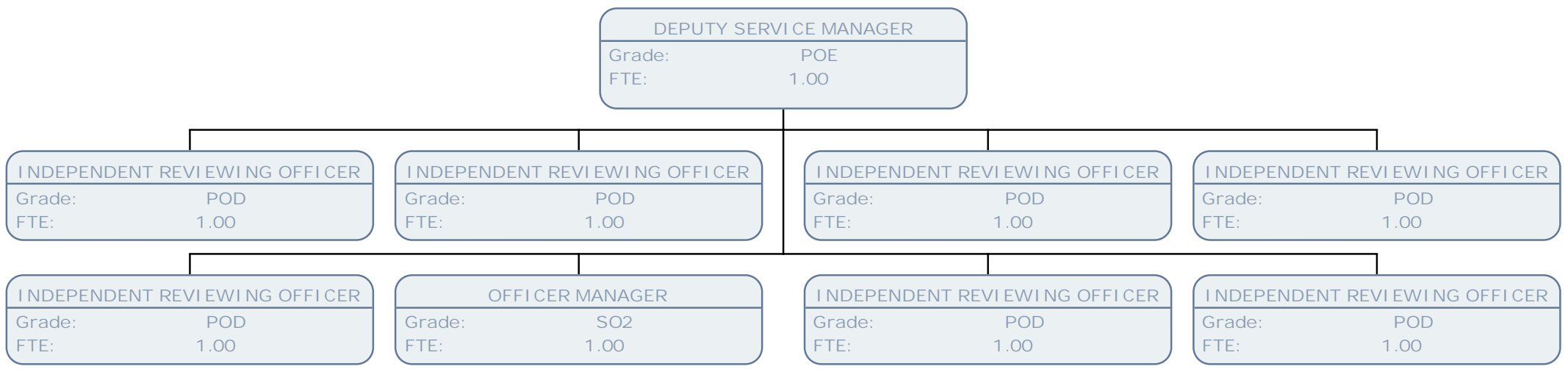

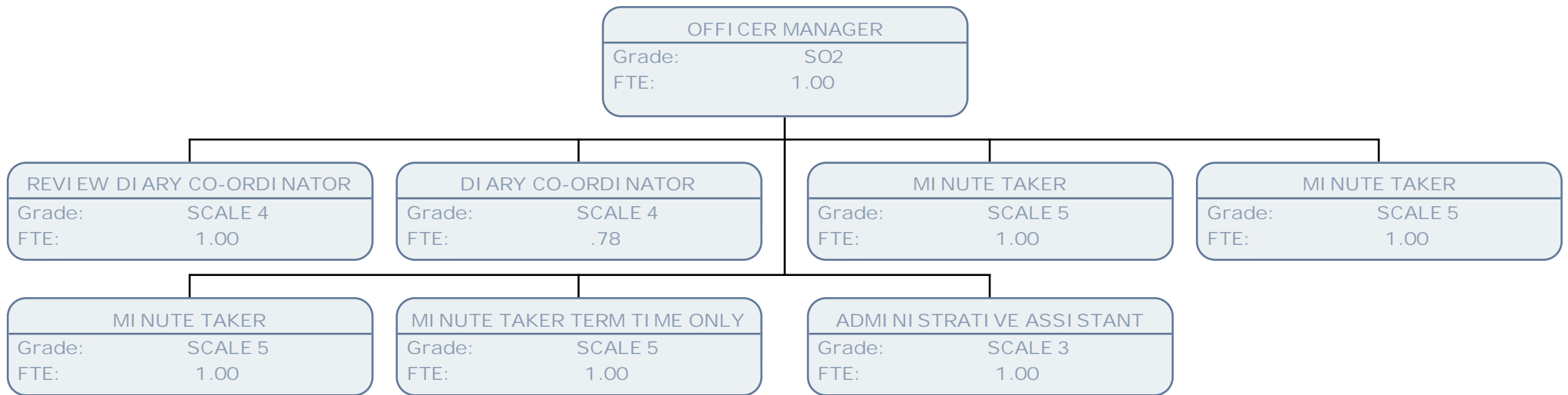

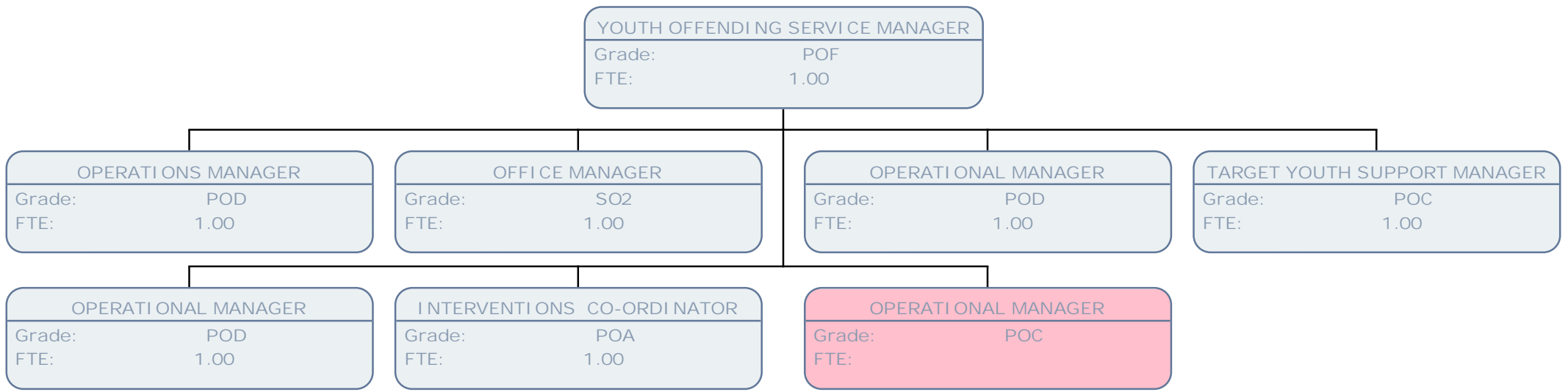

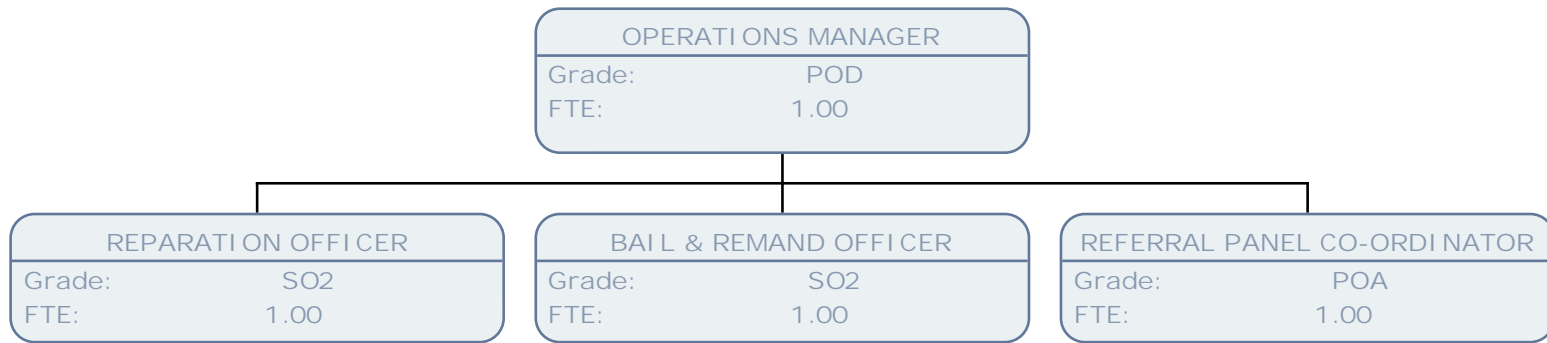

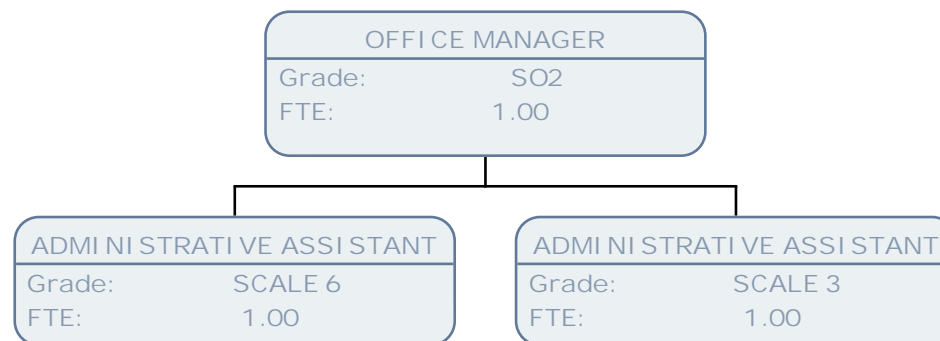

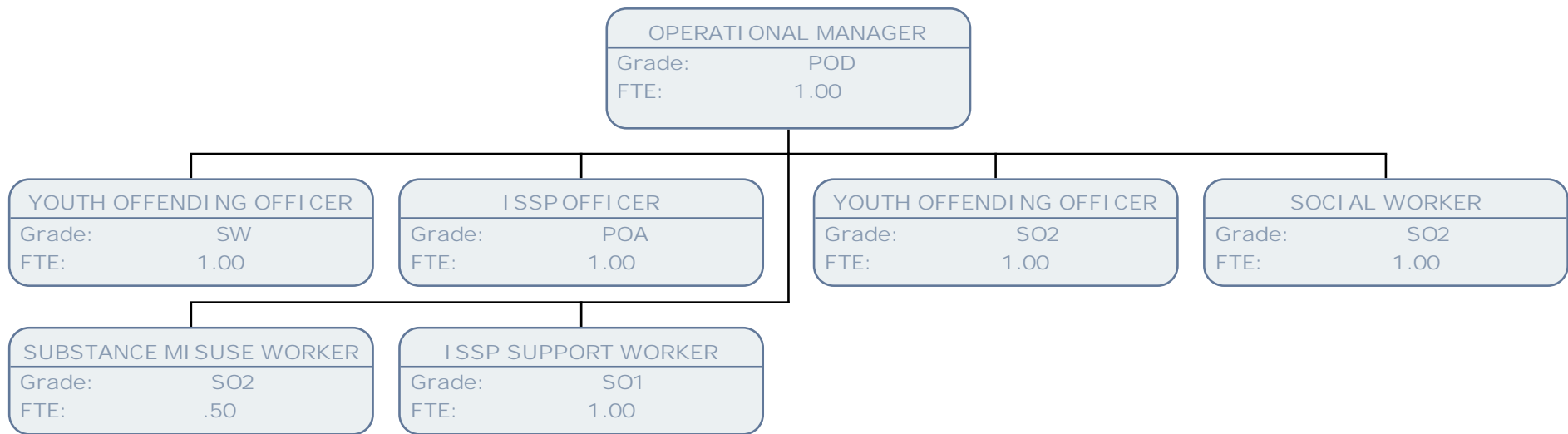

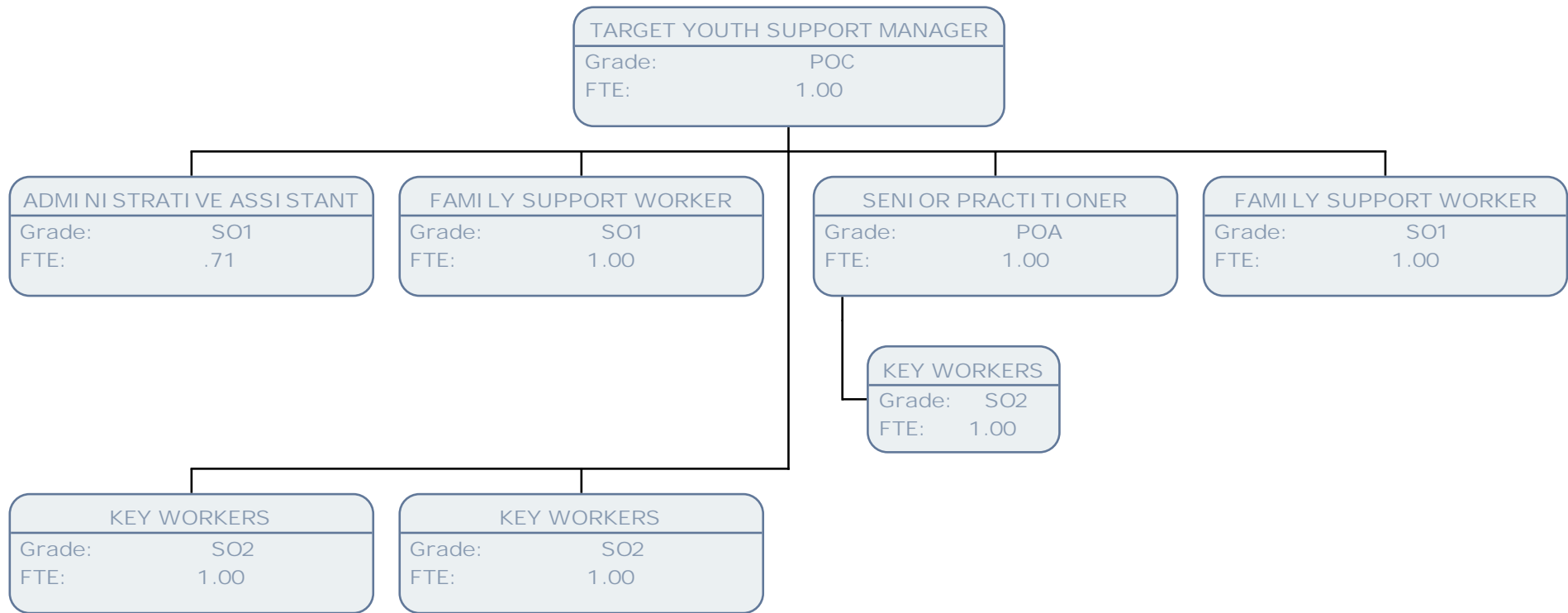

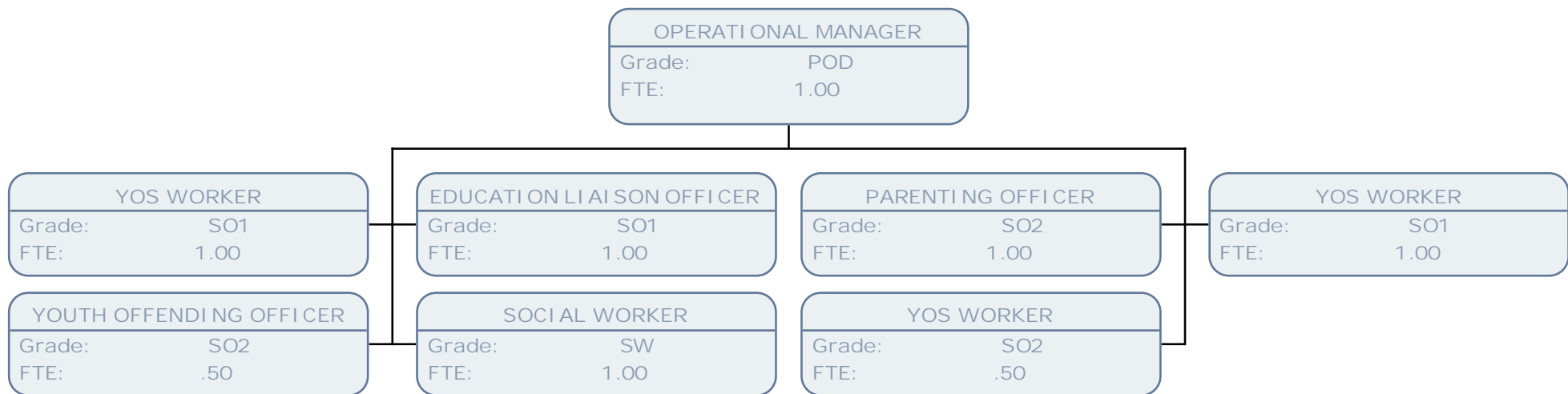

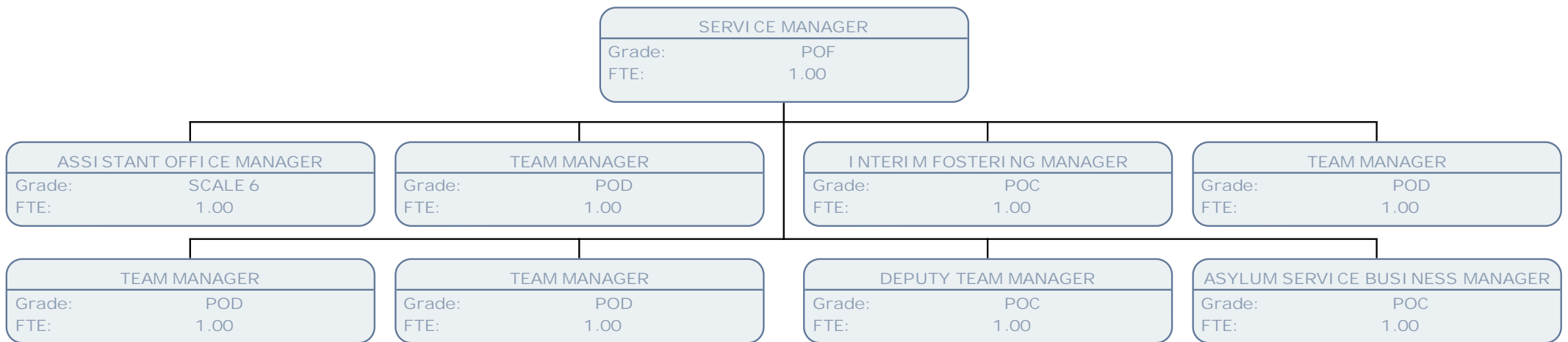

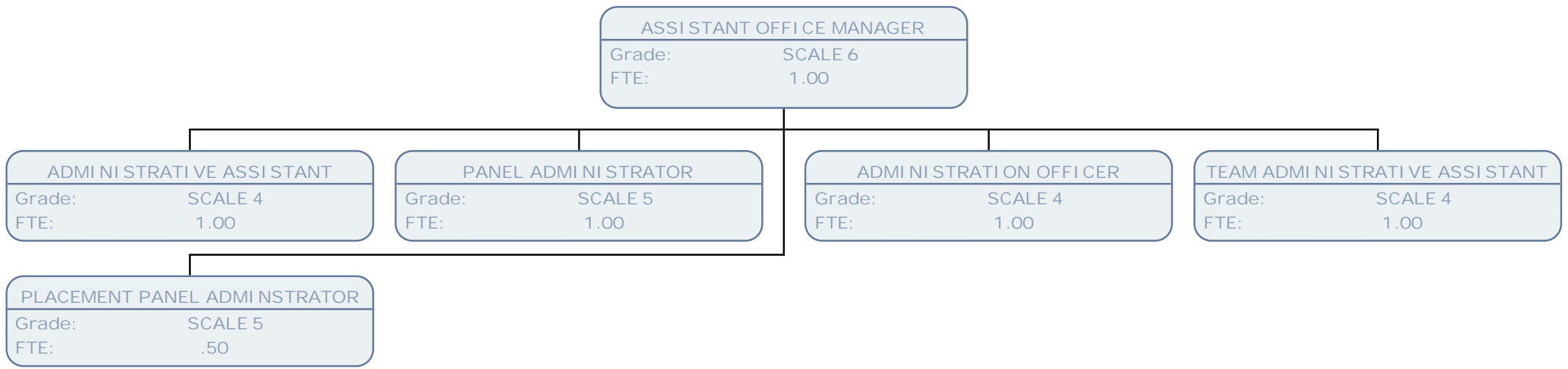

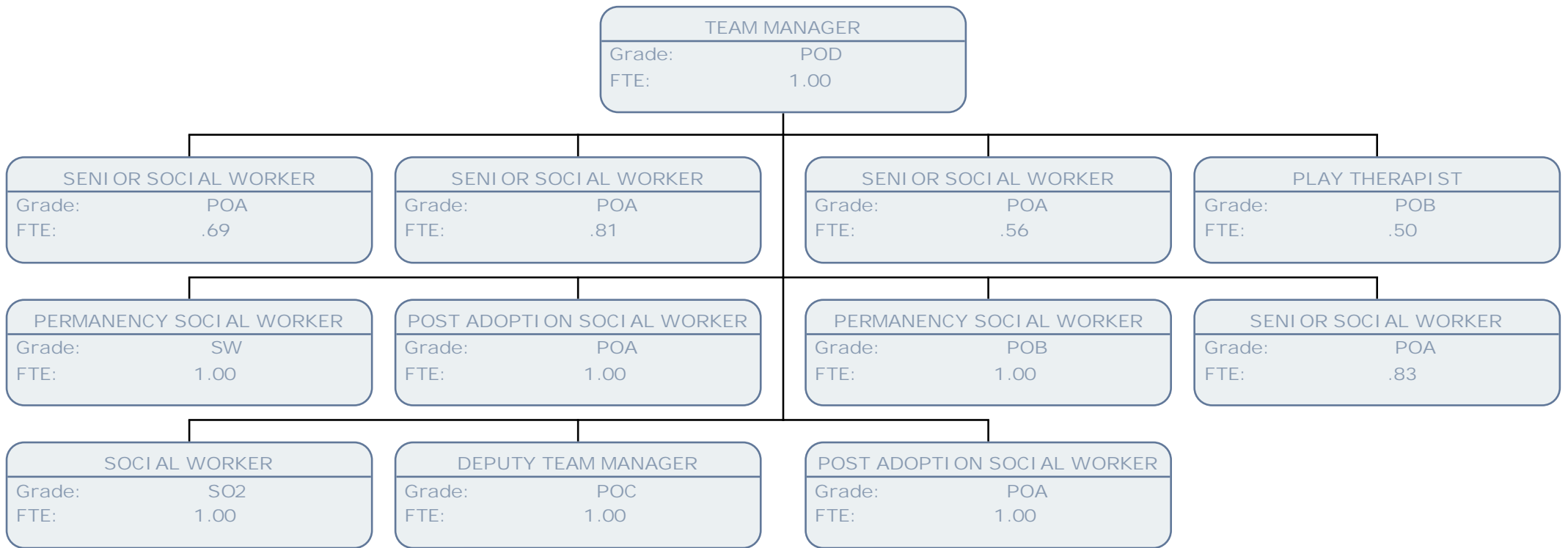

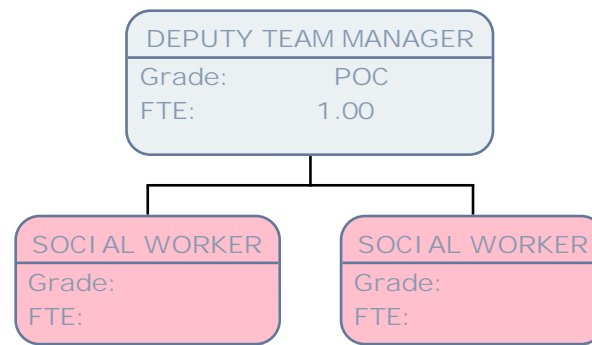

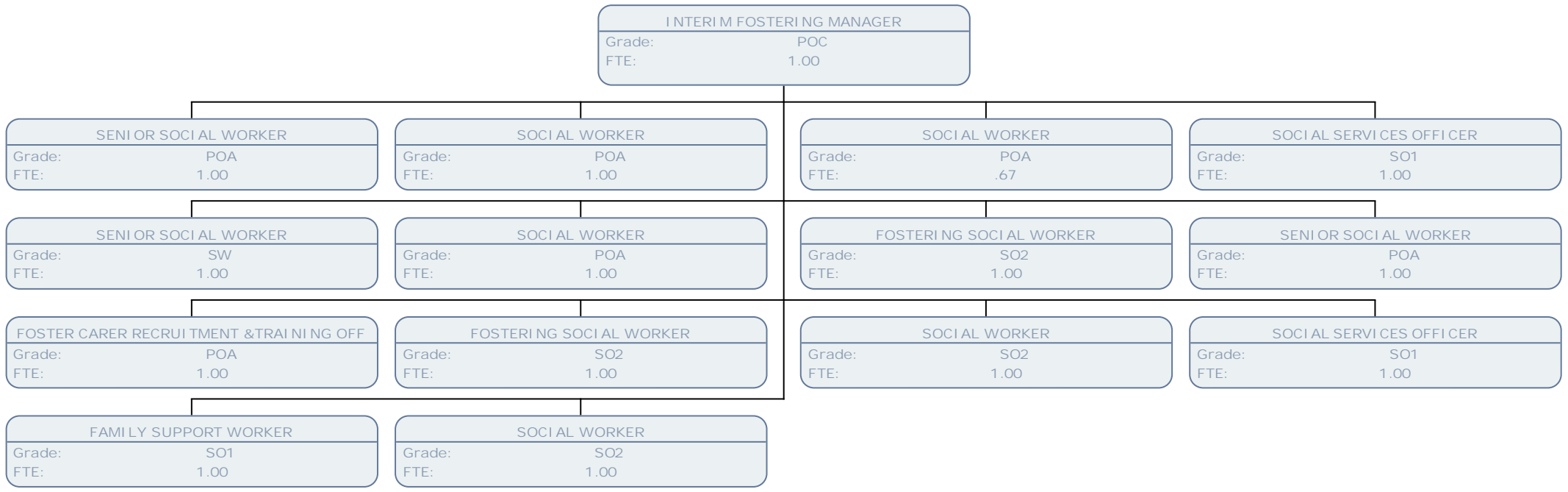

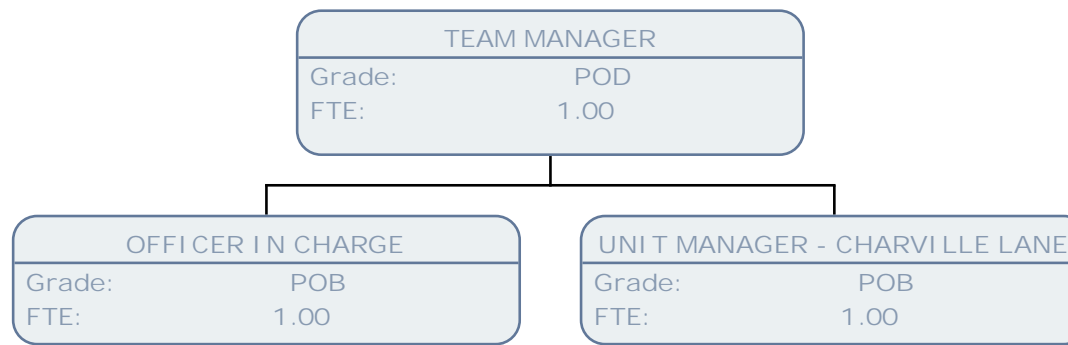

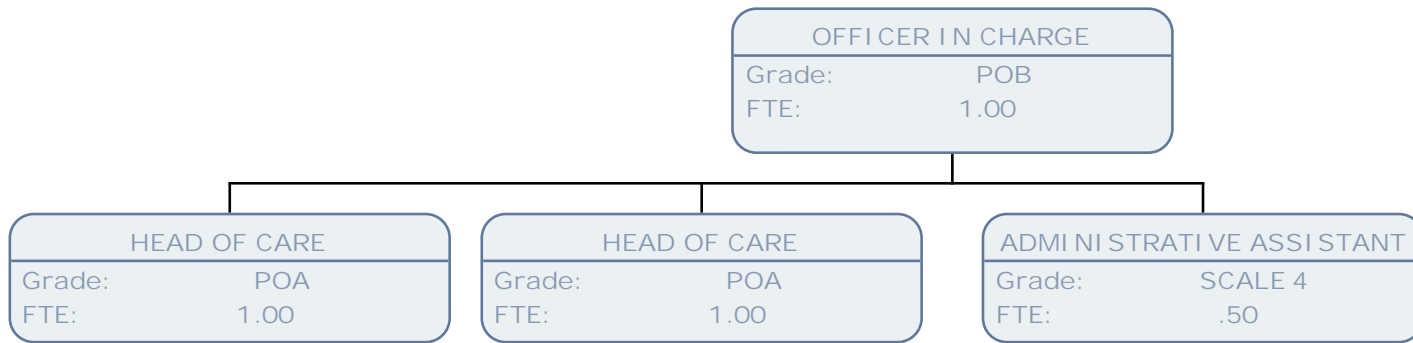

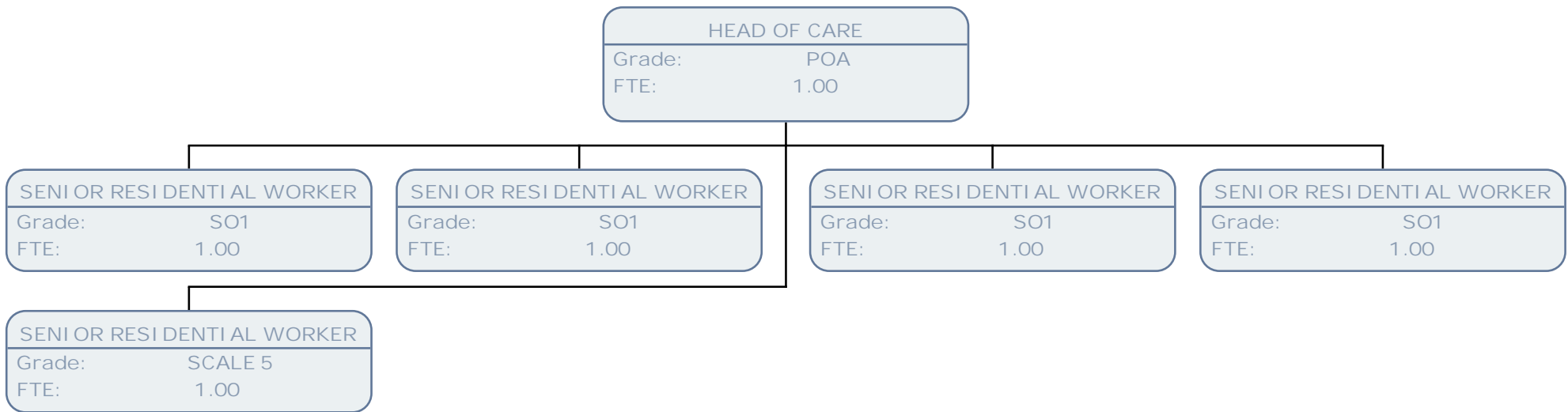

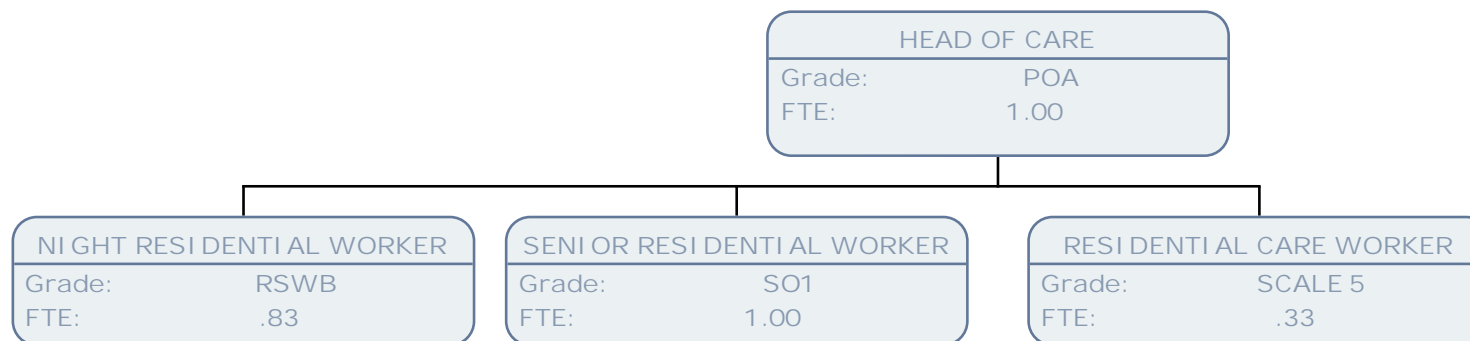

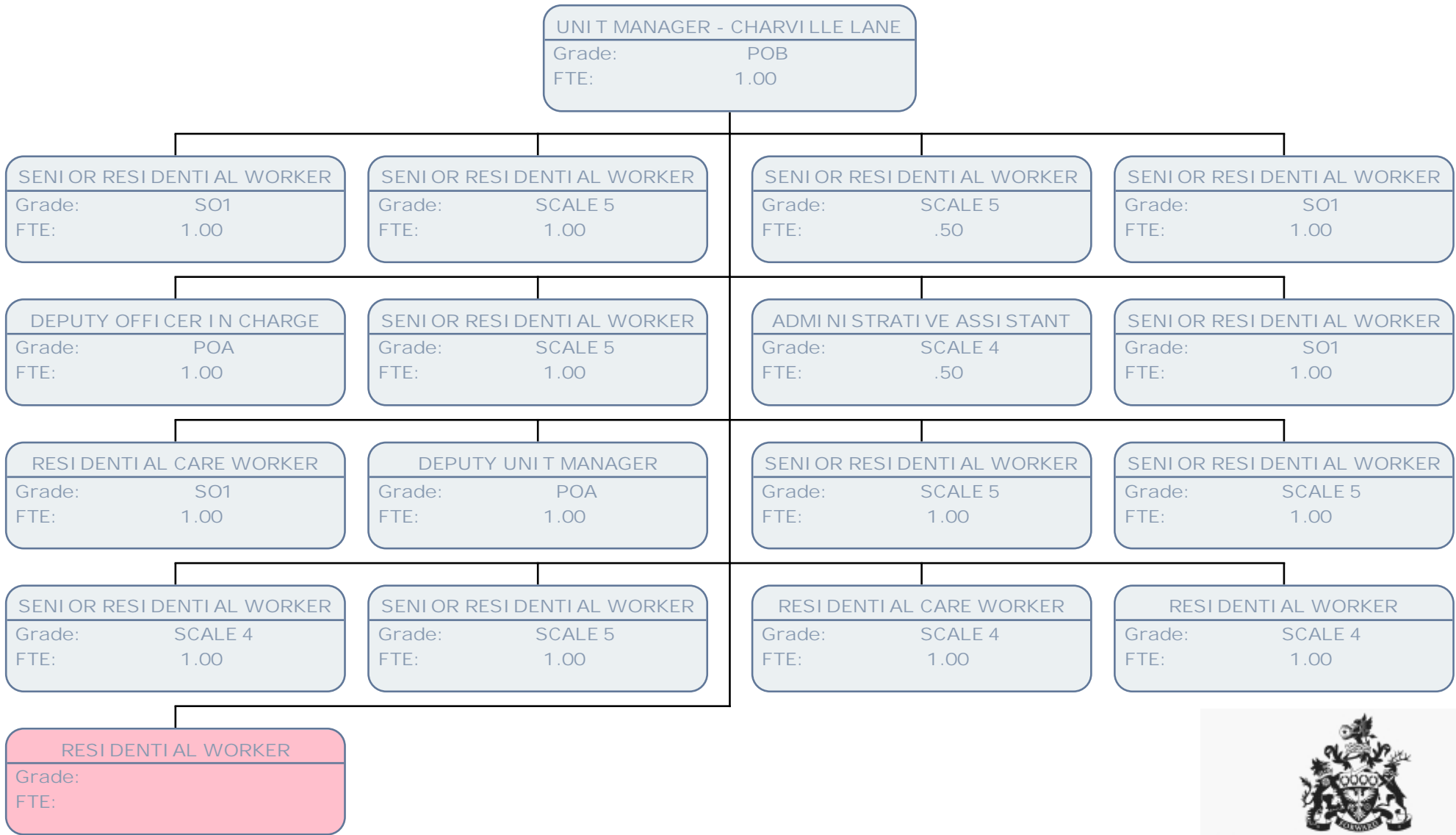

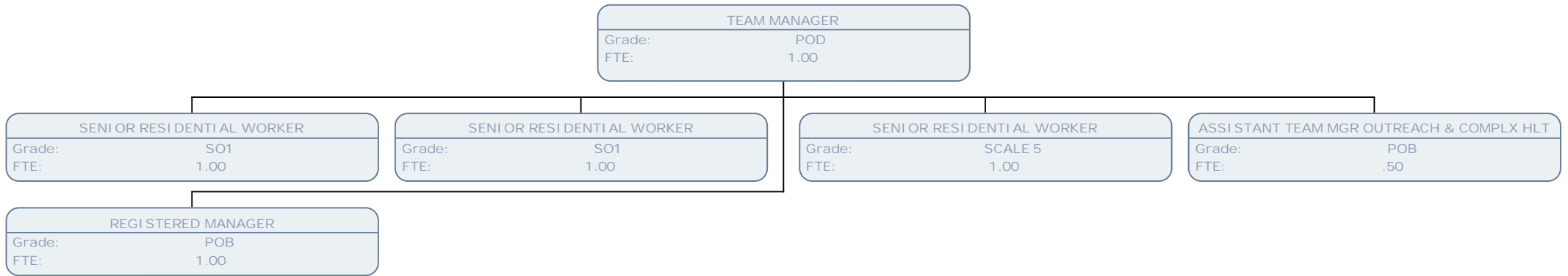

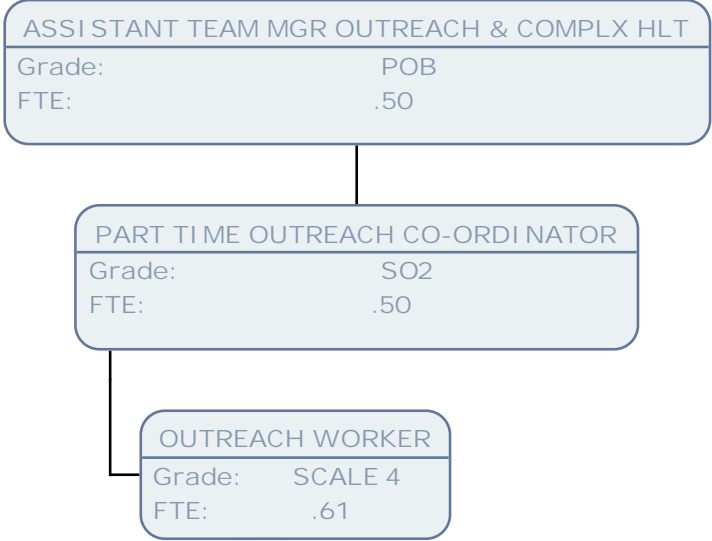

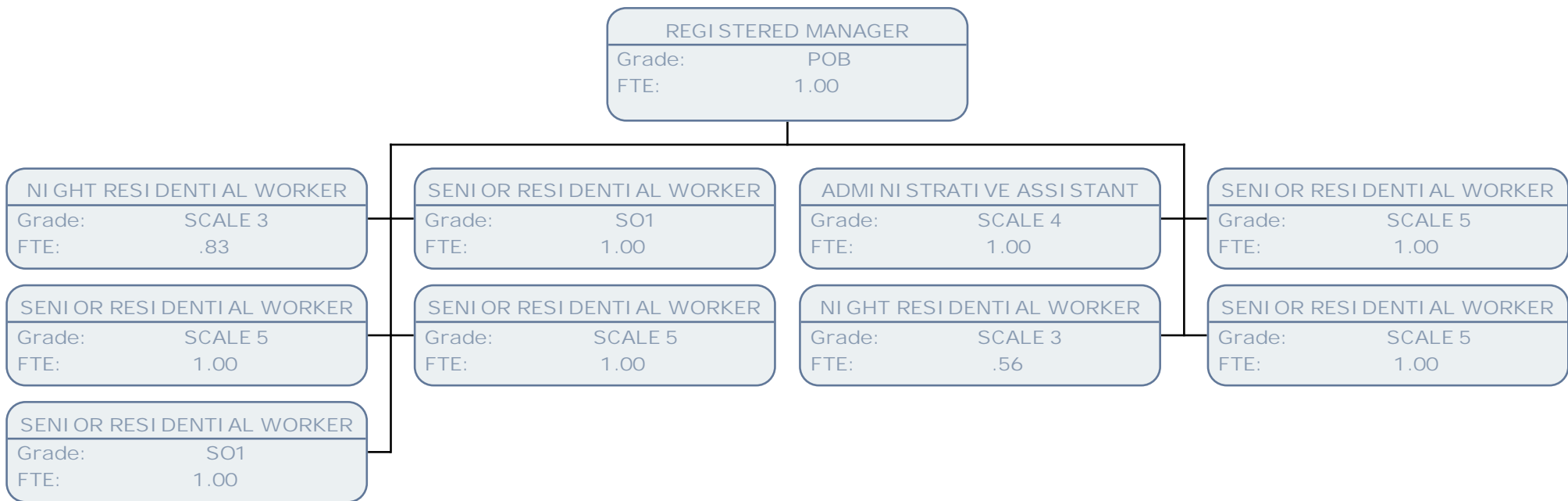

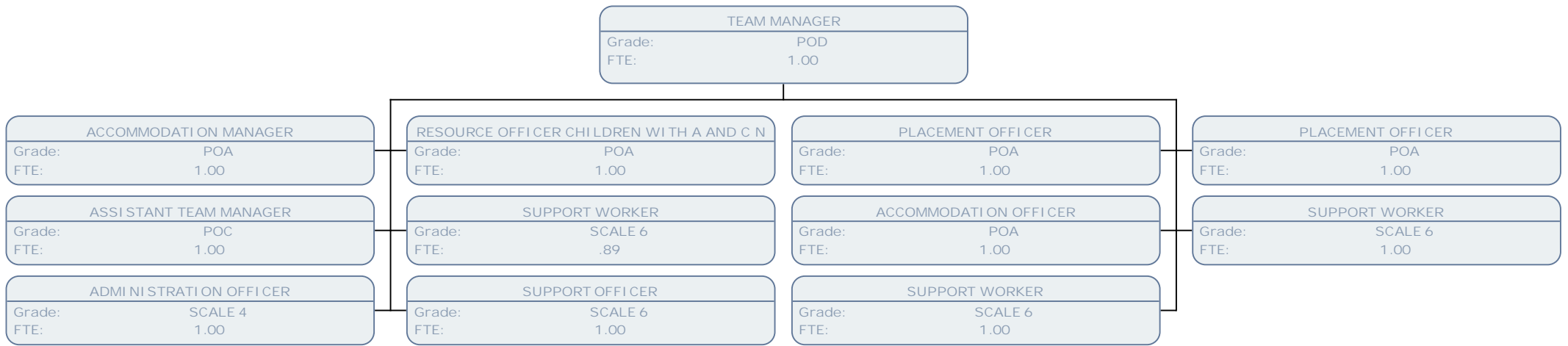

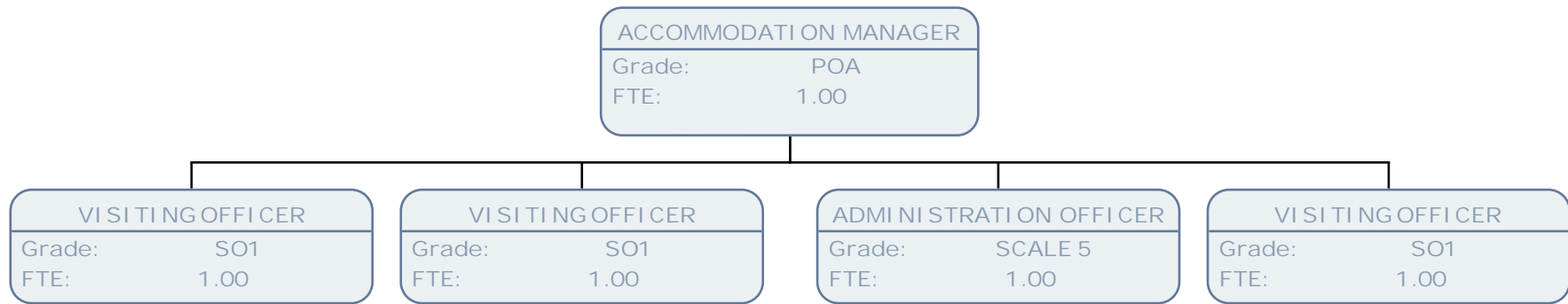

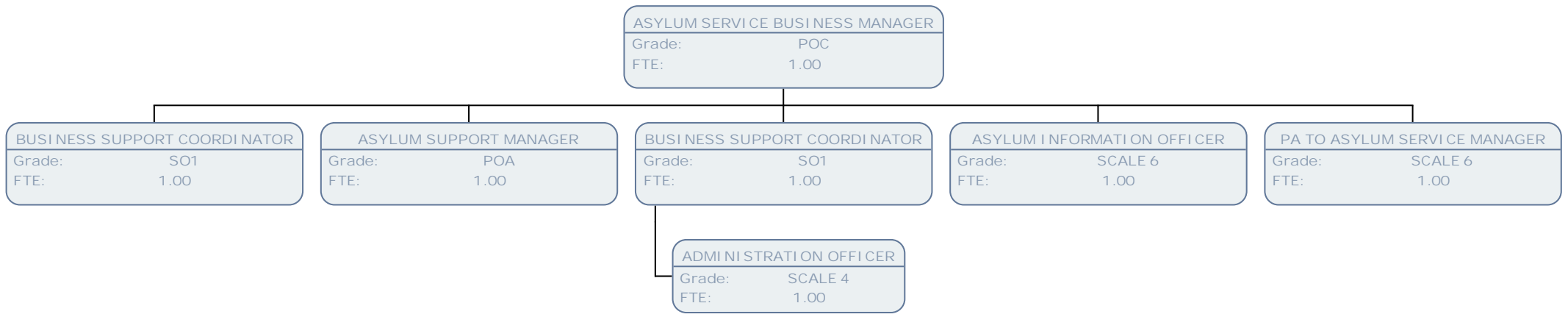

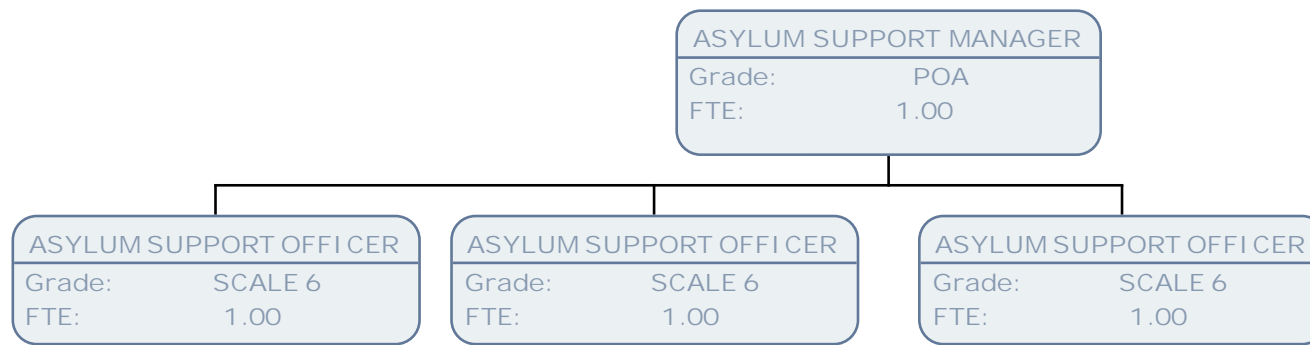

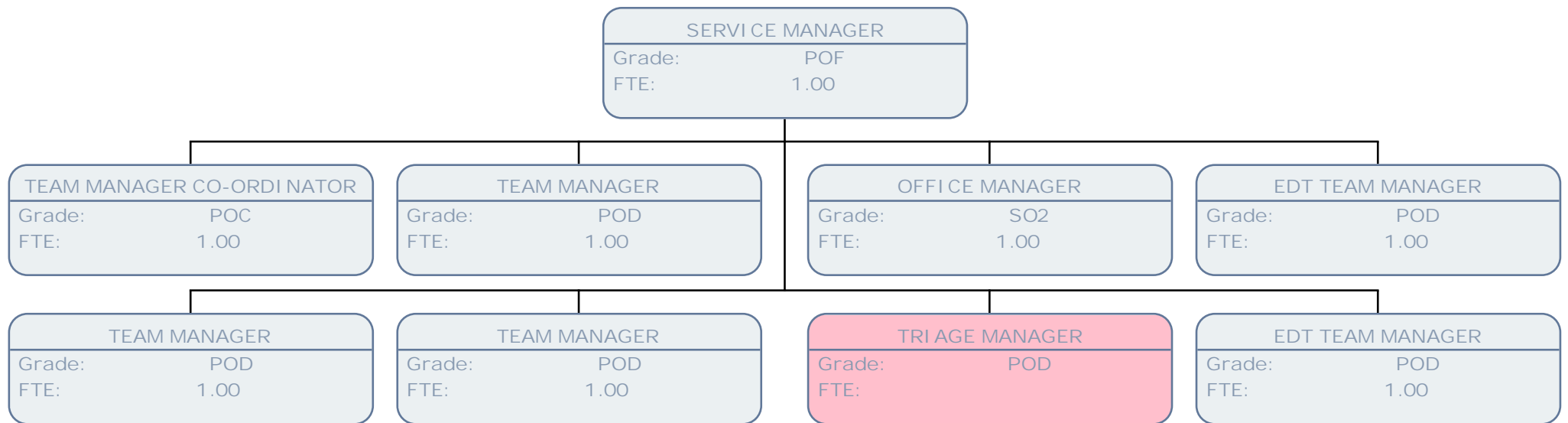

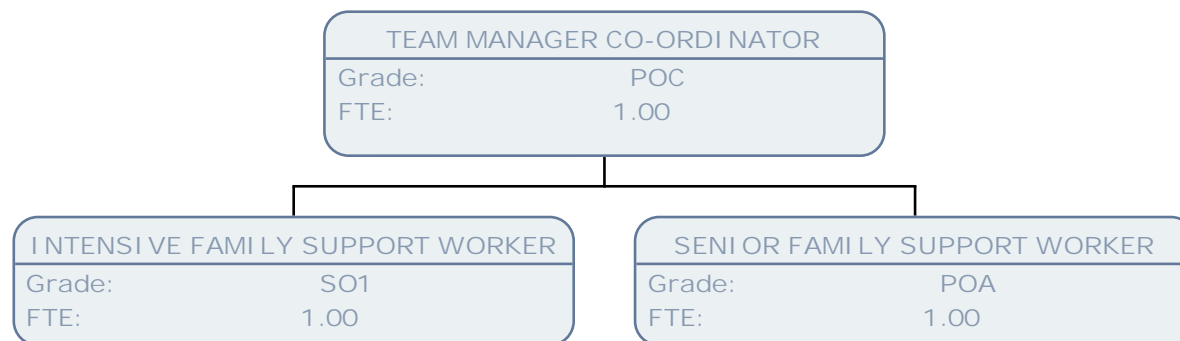

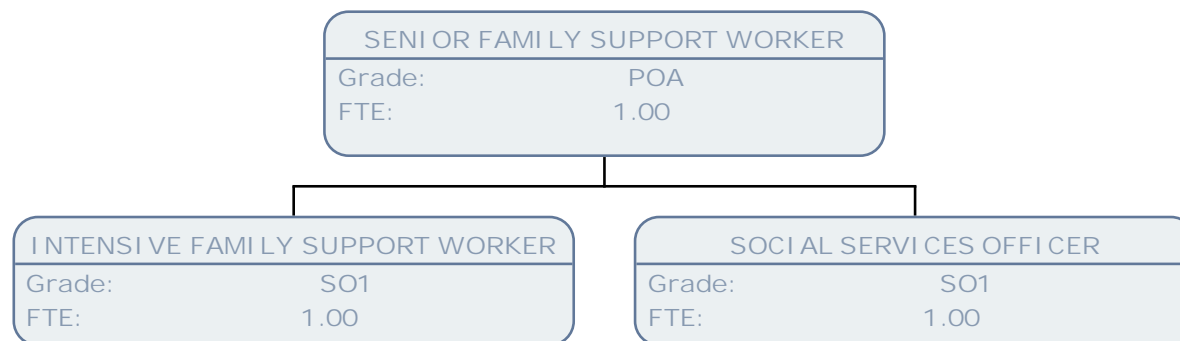

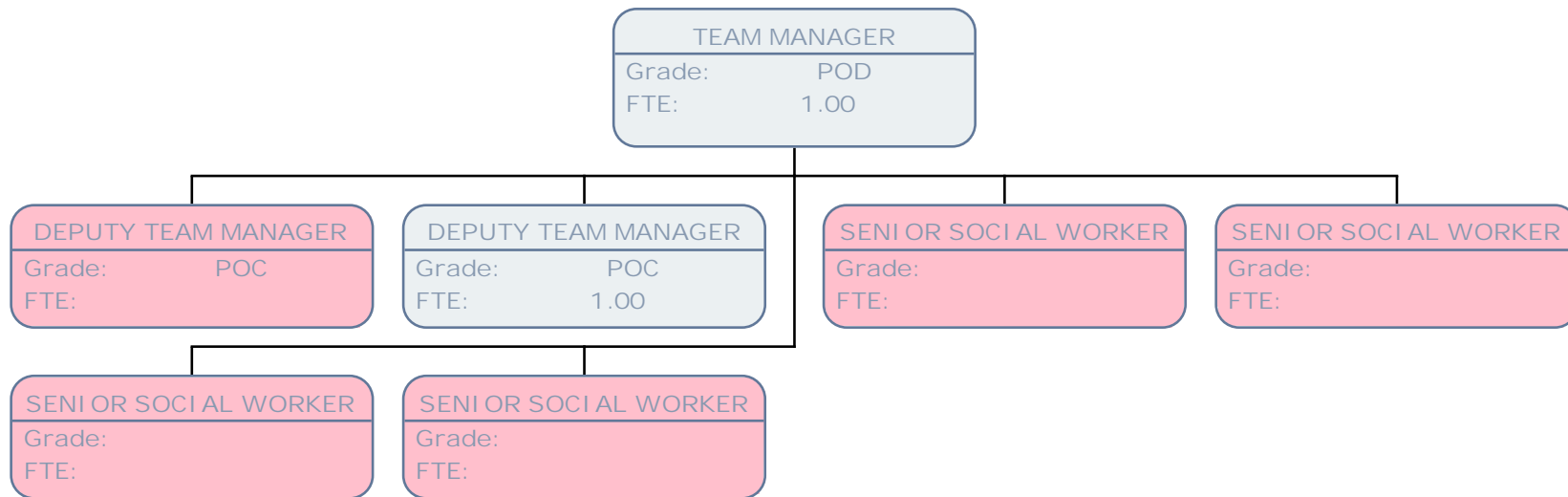

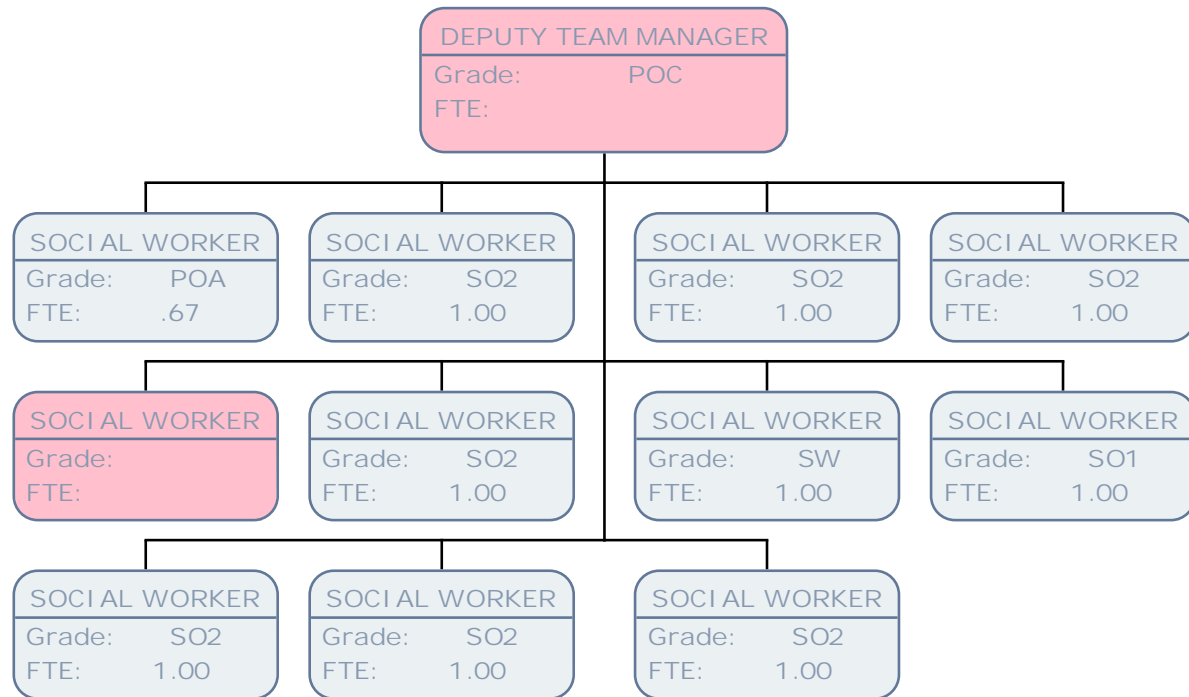

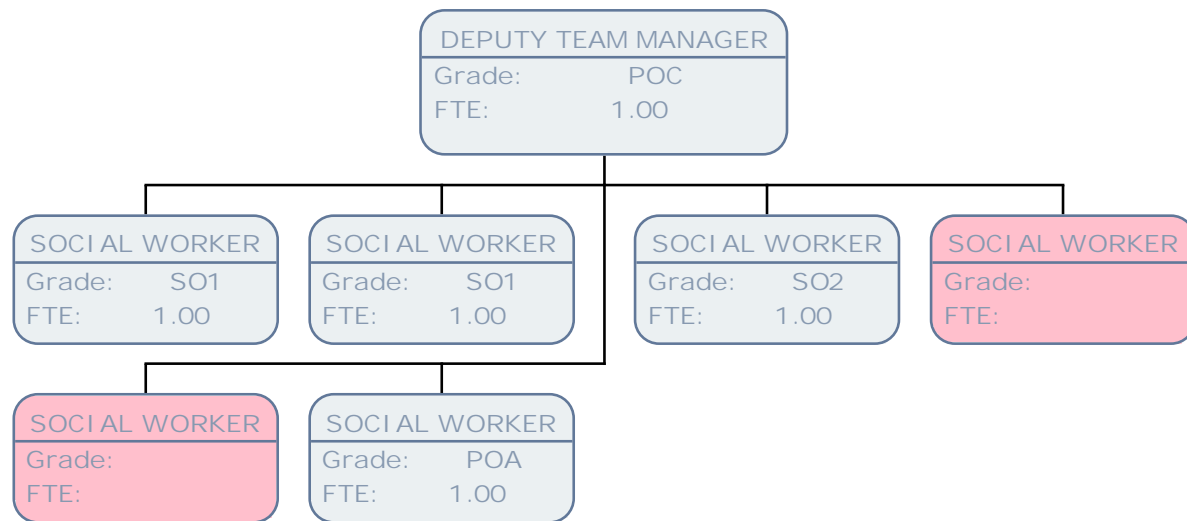

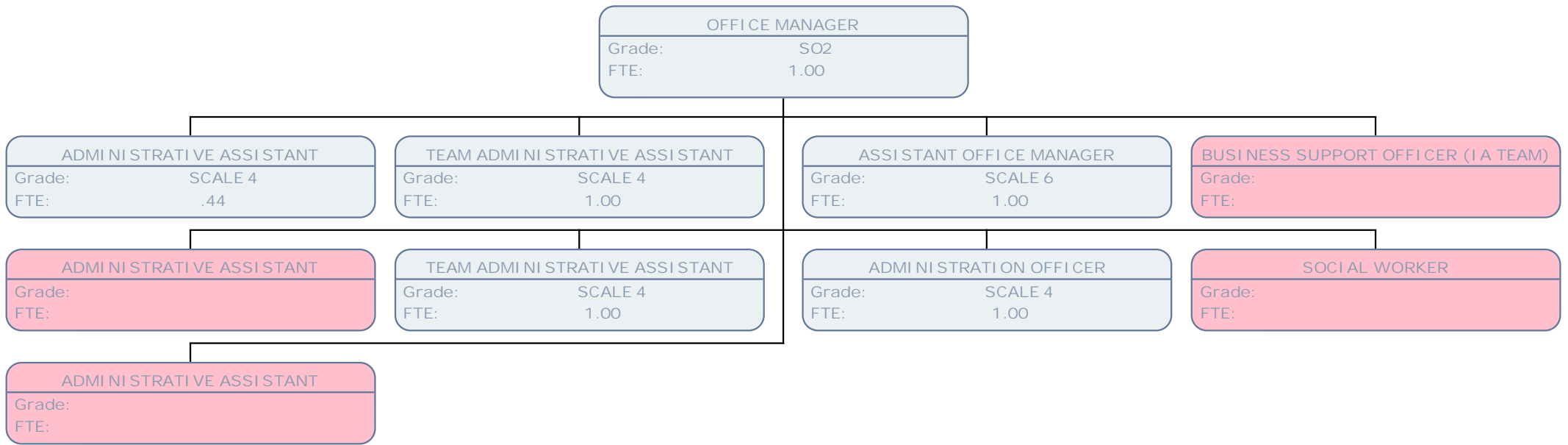

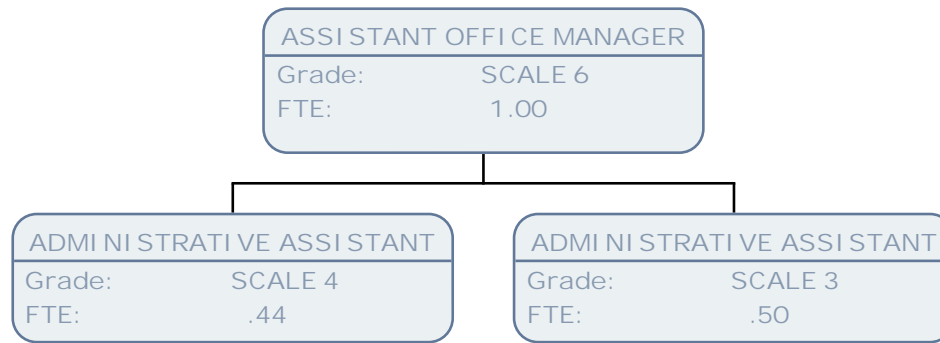

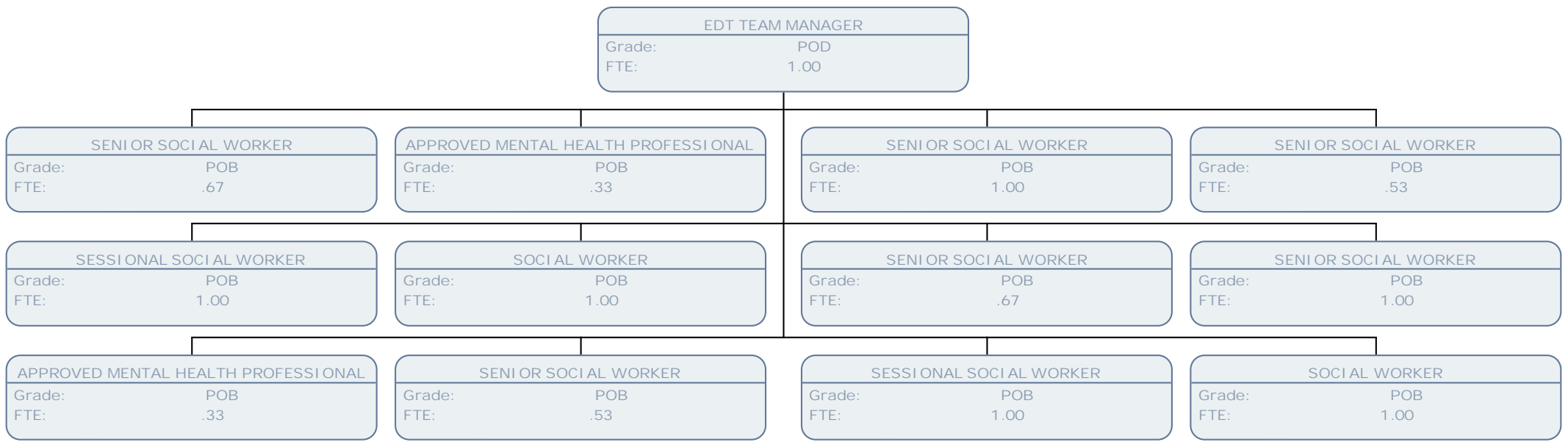

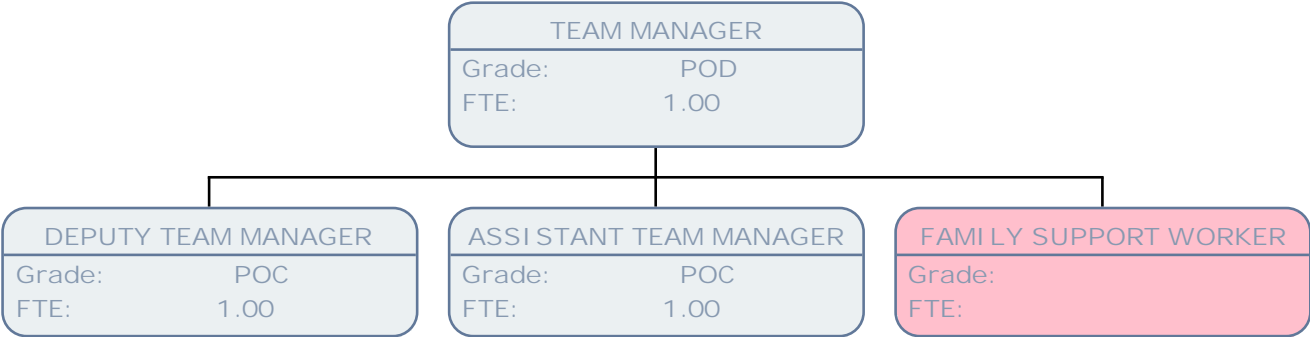

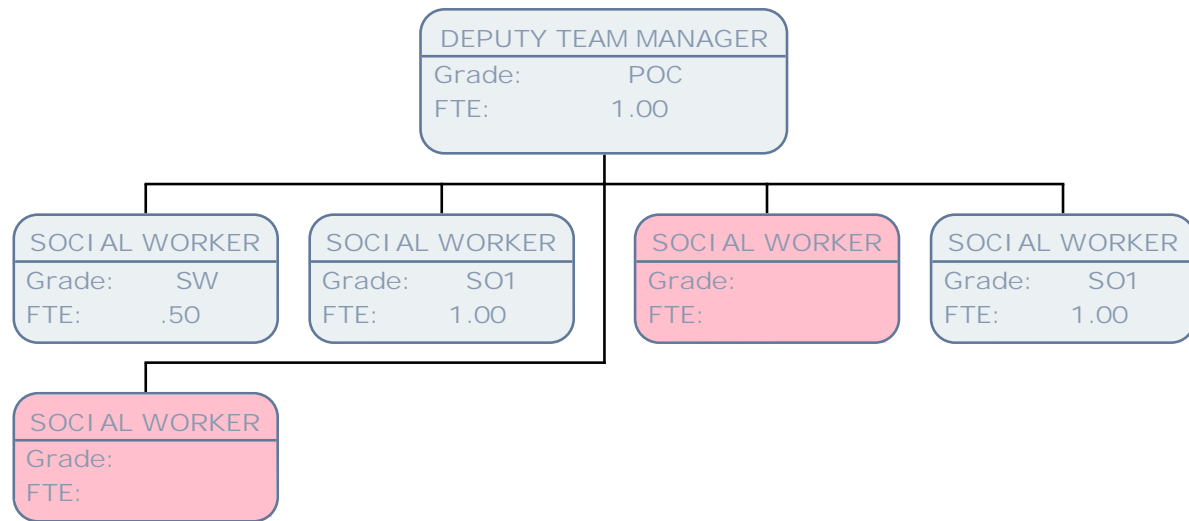

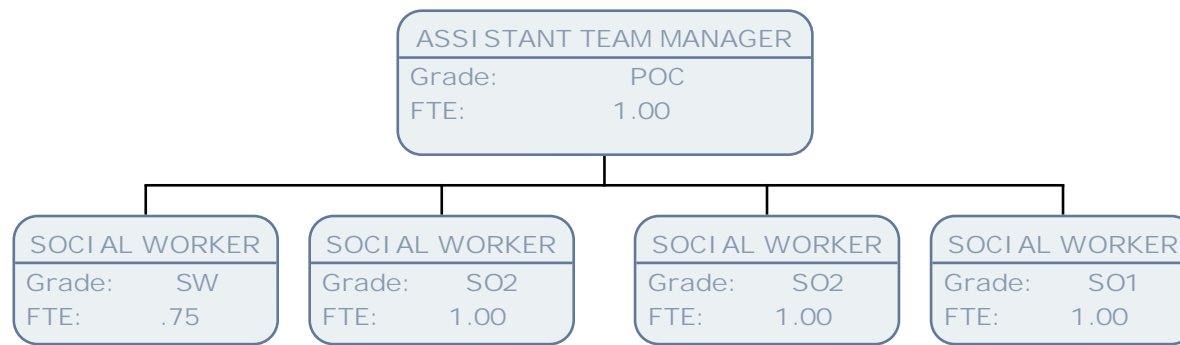

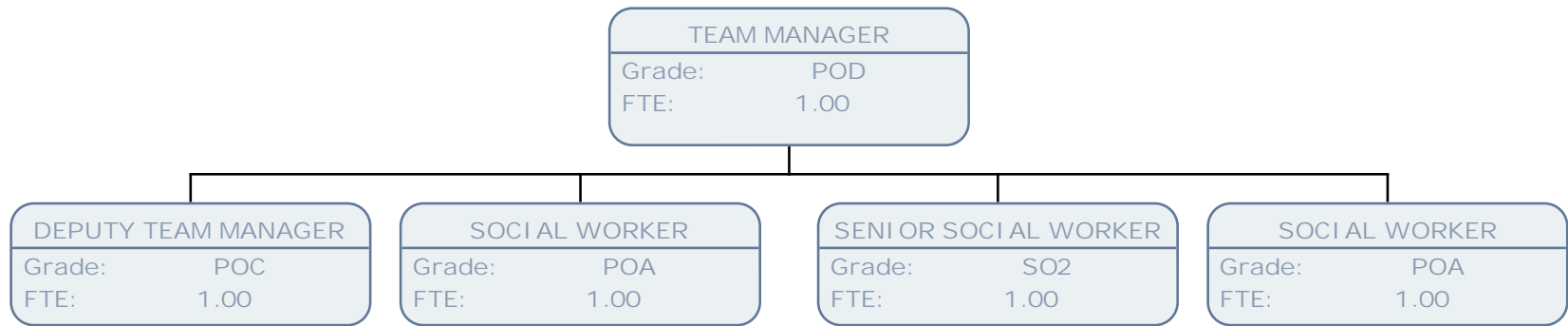

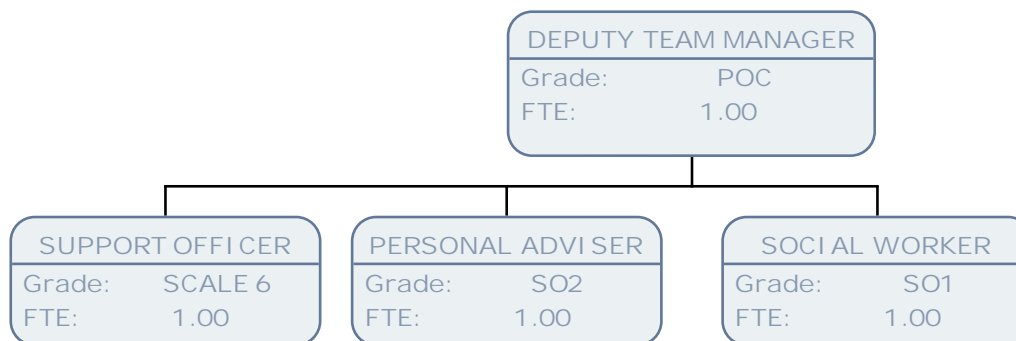

TRI AGE MANAGER	
Grade:	POD
FTE:	

CONTACTPOINT, & CAF CO-ORDI NATOR	
Grade:	SO2
FTE:	1.00

DEPUTY TEAM MANAGER	
Grade:	POC
FTE:	1.00

FAMI LY SUPPORT WORKER	
Grade:	SO1
FTE:	1.00



