

Resident Services Chart

March 13

Resident Services

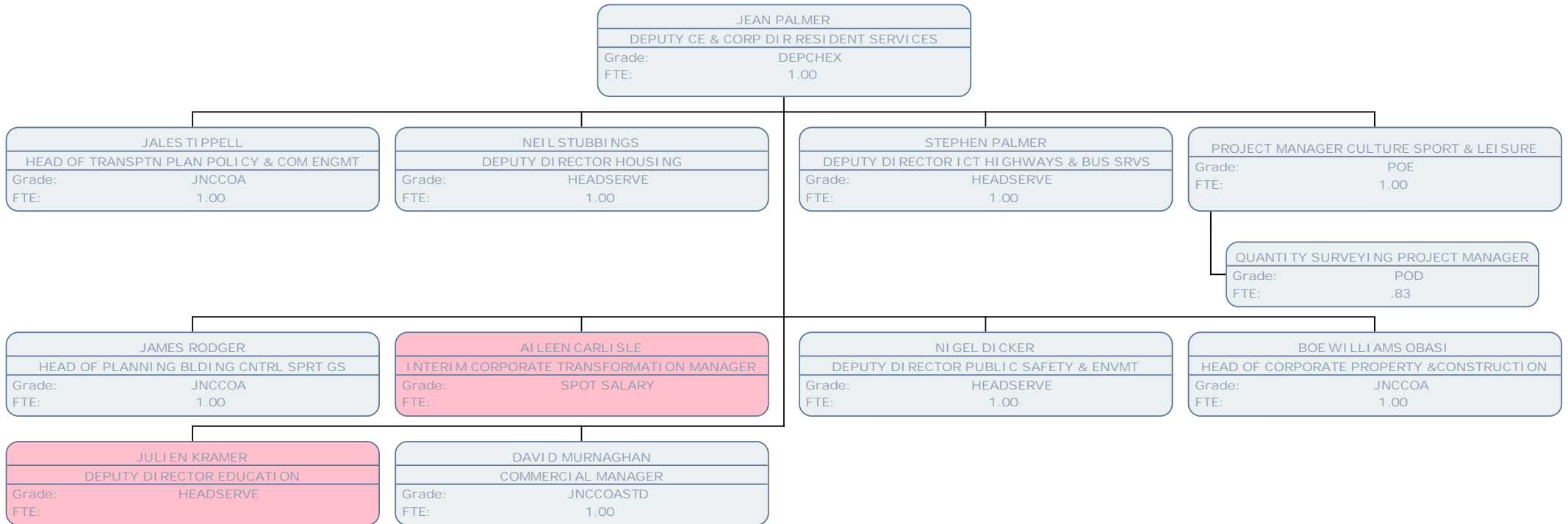

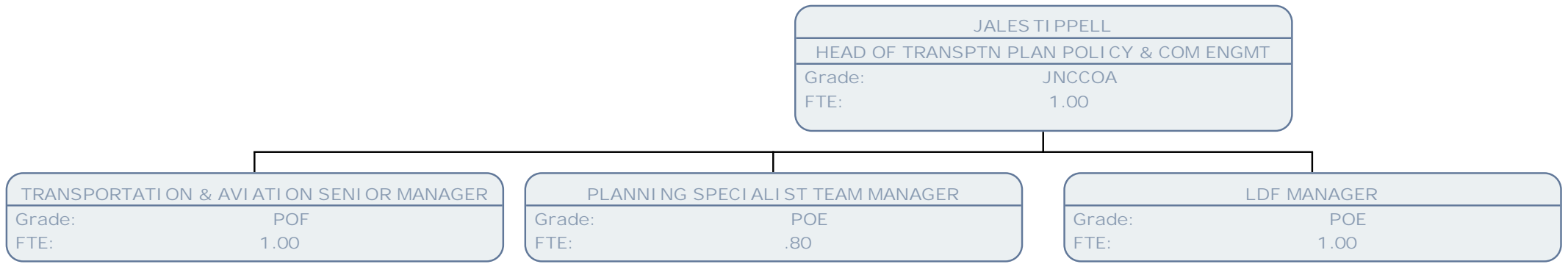

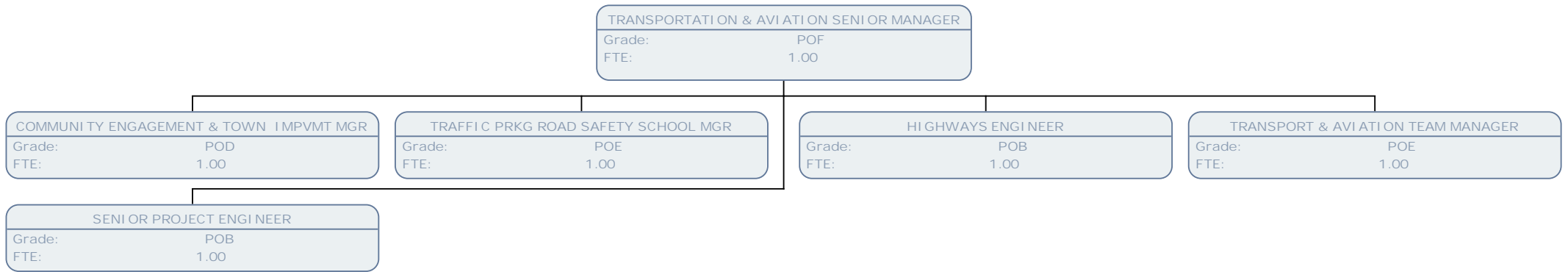

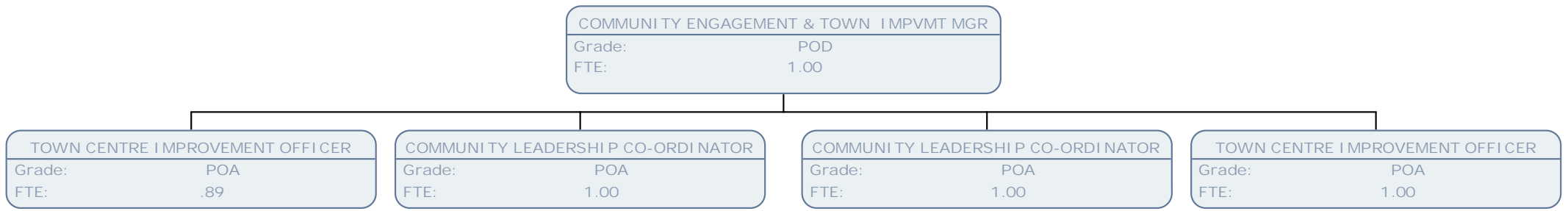

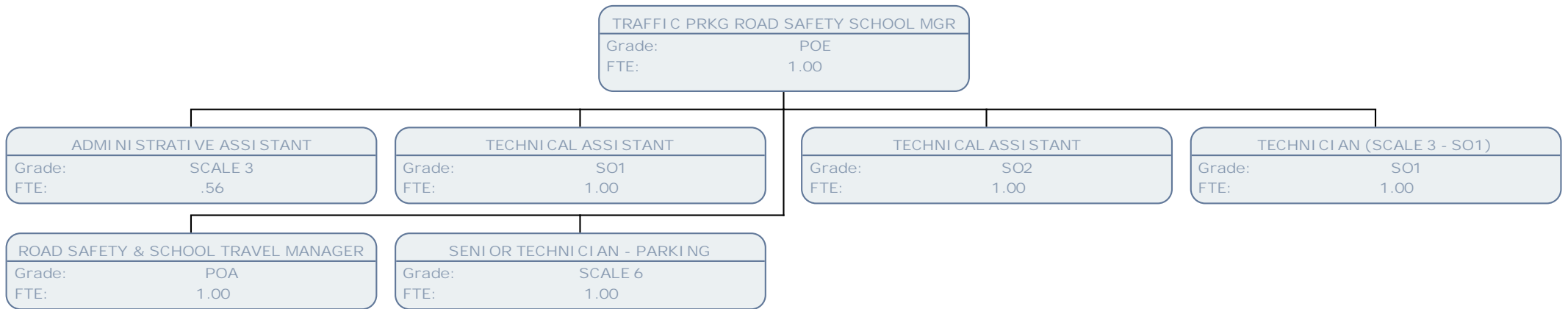

ROAD SAFETY & SCHOOL TRAVEL MANAGER
 Grade: POA
 FTE: 1.00

SAFER ROUTES TO SCHOOL OFFICER
 Grade: SO2
 FTE: 1.00

SCHOOL CROSSING ATTENDANT
 Grade: SCALE 1C
 FTE: .28

SCHOOL CROSSING ATTENDANT
 Grade: SCALE 1C
 FTE: .26

SCHOOL CROSSING ATTENDANT
 Grade: SCALE 1C
 FTE: .28

SCHOOL CROSSING ATTENDANT
 Grade: SCALE 1C
 FTE: .28

SCHOOL CROSSING ATTENDANT
 Grade: SCALE 1C
 FTE: .28

SCHOOL CROSSING ATTENDANT
 Grade: SCALE 1C
 FTE: .20

SCHOOL CROSSING ATTENDANT
 Grade: SCALE 1C
 FTE: .28

SCHOOL CROSSING ATTENDANT
 Grade: SCALE 1C
 FTE: .24

SCHOOL CROSSING ATTENDANT
 Grade: SCALE 1C
 FTE: .19

SCHOOL CROSSING ATTENDANT
 Grade: SCALE 1C
 FTE: .28

SCHOOL CROSSING ATTENDANT
 Grade: SCALE 1C
 FTE: .28

SCHOOL CROSSING ATTENDANT
 Grade: SCALE 1C
 FTE: .28

SCHOOL CROSSING ATTENDANT
 Grade: SCALE 1C
 FTE: .28

SCHOOL CROSSING ATTENDANT
 Grade: SCALE 1C
 FTE: .28

SCHOOL CROSSING ATTENDANT
 Grade: SCALE 1C
 FTE: .28

SCHOOL CROSSING ATTENDANT
 Grade: SCALE 1C
 FTE: .28

SCHOOL CROSSING ATTENDANT
 Grade: SCALE 1C
 FTE: .28

SCHOOL CROSSING ATTENDANT
 Grade: SCALE 1C
 FTE: .28

SCHOOL CROSSING ATTENDANT
 Grade: SCALE 1C
 FTE: .28

ROAD SAFETY OFFICER ASSISTANT
 Grade: SO2
 FTE: 1.00

SCHOOL CROSSING ATTENDANT
 Grade: SCALE 1C
 FTE: .28

SCHOOL CROSSING ATTENDANT
 Grade: SCALE 1C
 FTE: .28

SCHOOL CROSSING ATTENDANT
 Grade: SCALE 1C
 FTE: .28

SCHOOL CROSSING ATTENDANT
 Grade: SCALE 1C
 FTE: .28

SCHOOL CROSSING ATTENDANT
 Grade: SCALE 1C
 FTE: .28

SCHOOL CROSSING ATTENDANT
 Grade: SCALE 1C
 FTE: .28



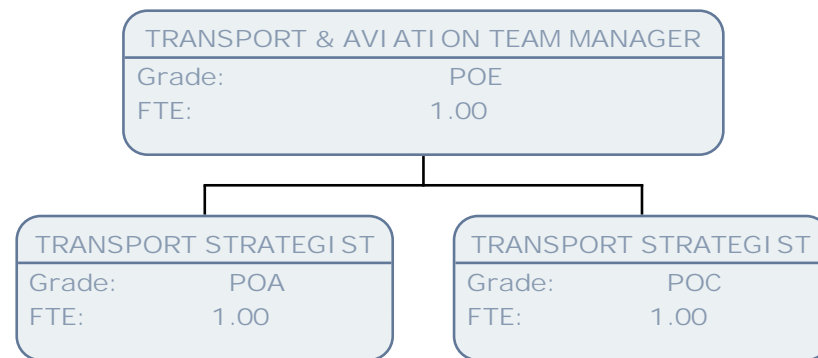

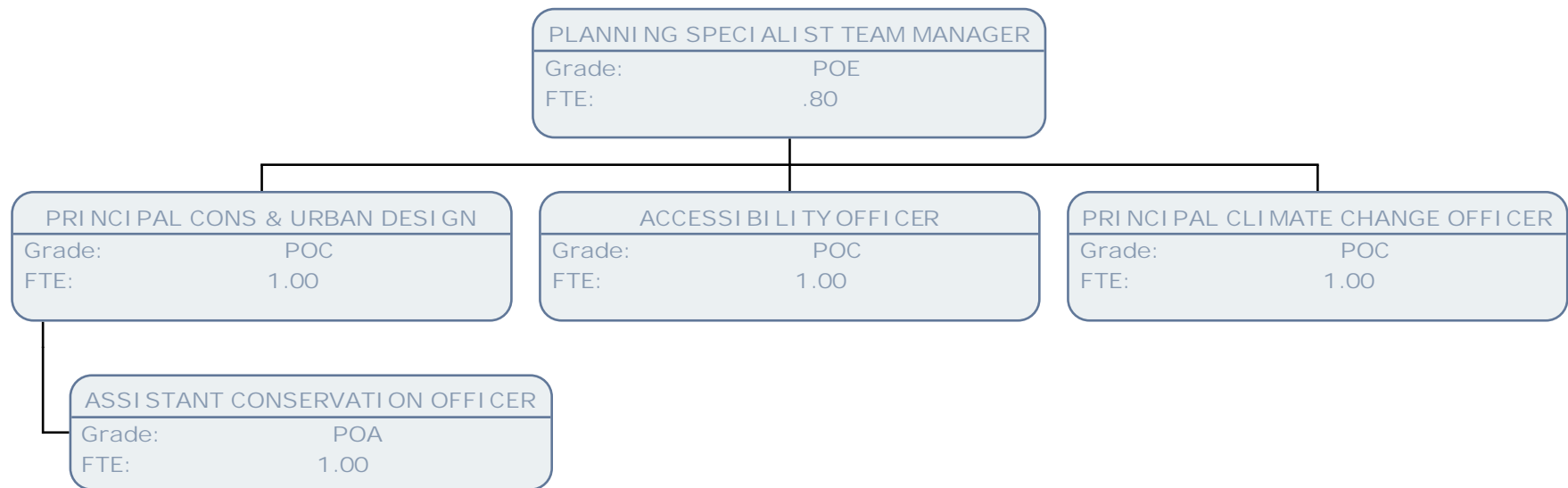

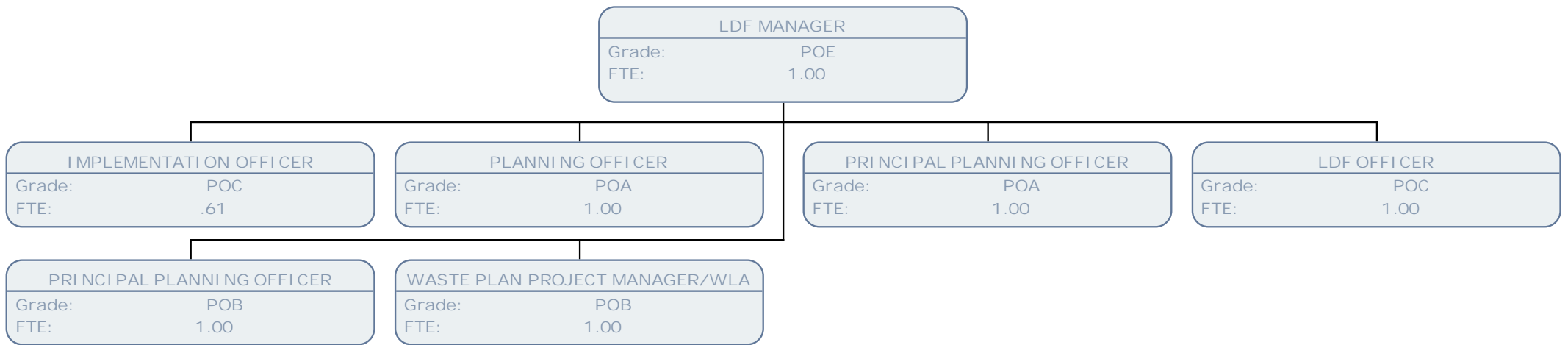

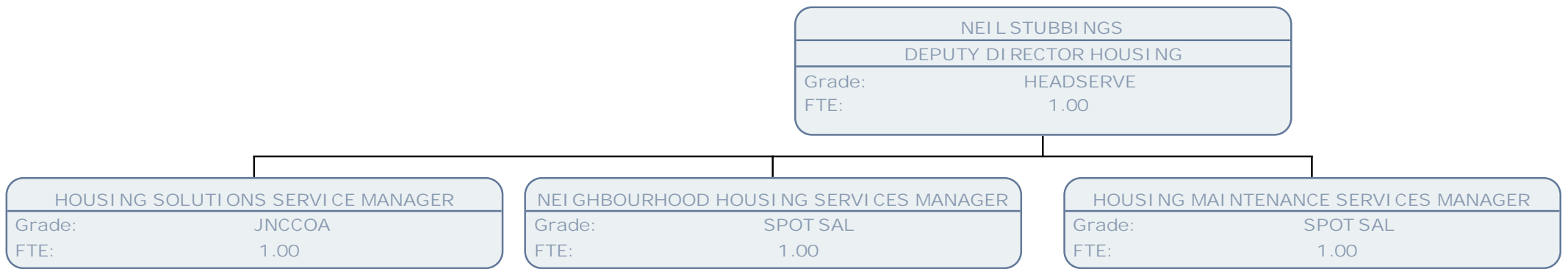

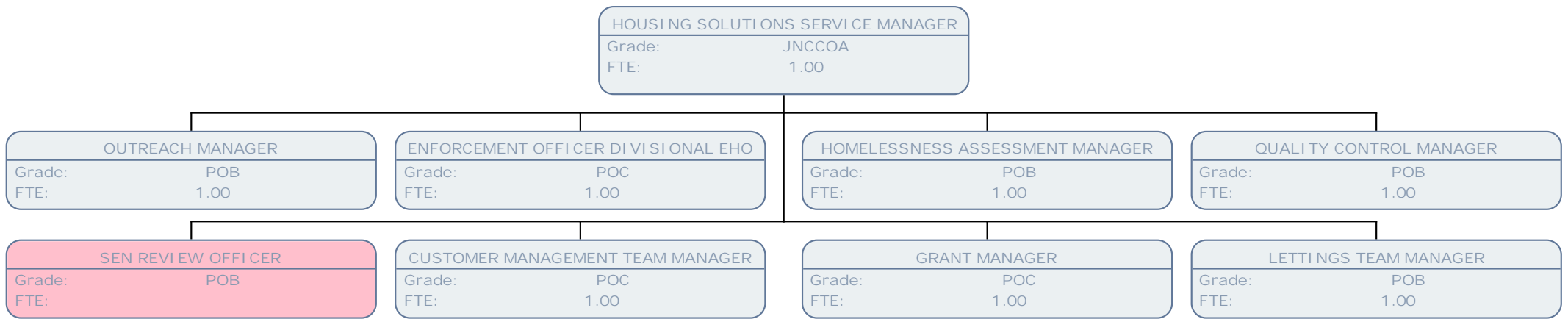

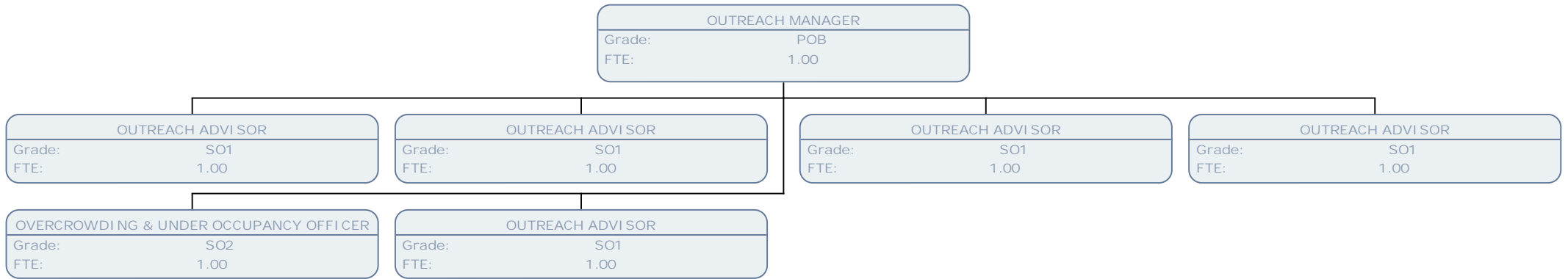

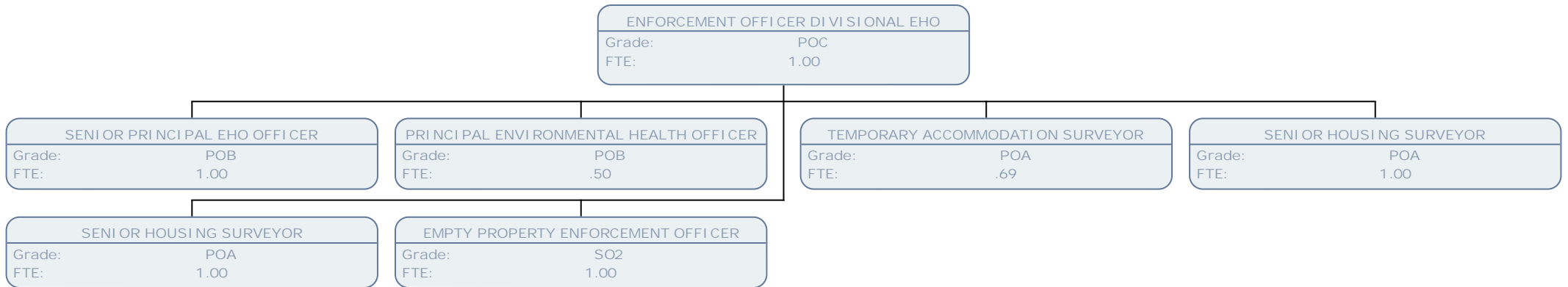

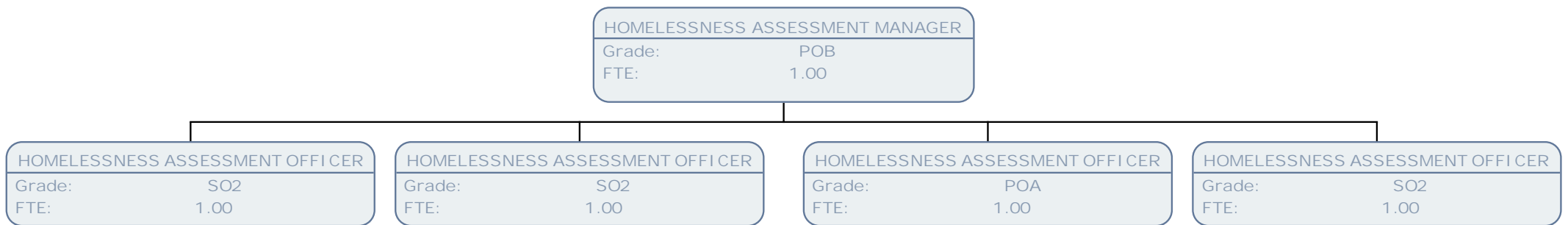

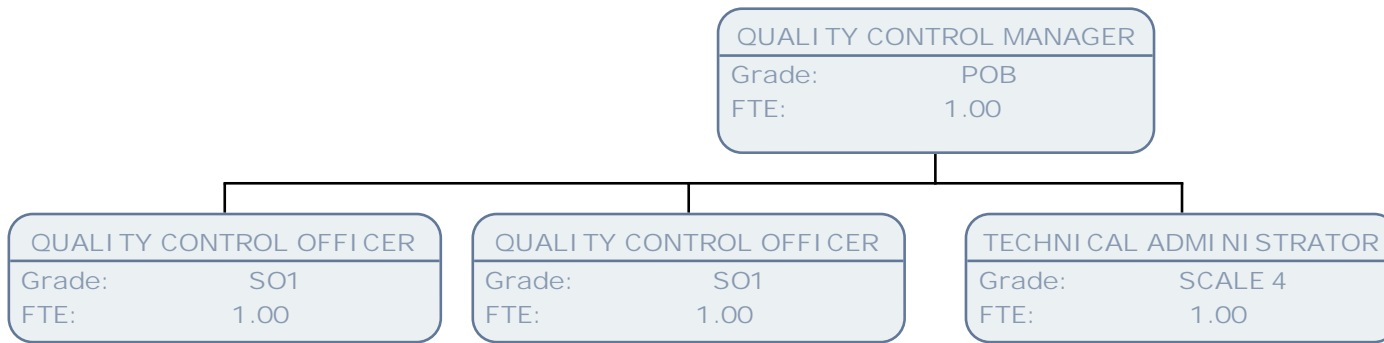

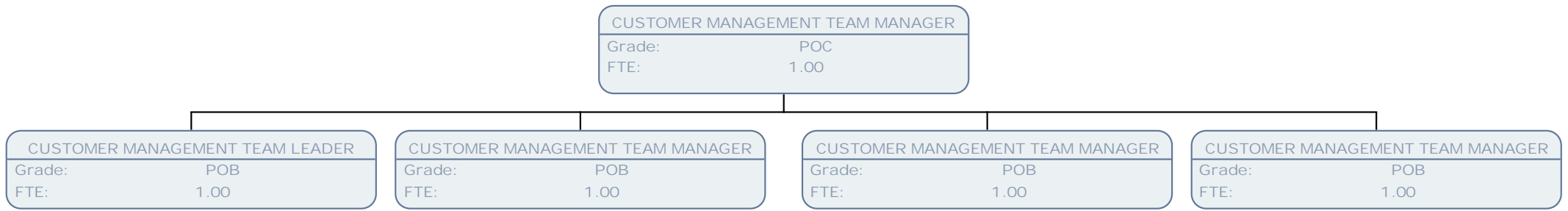

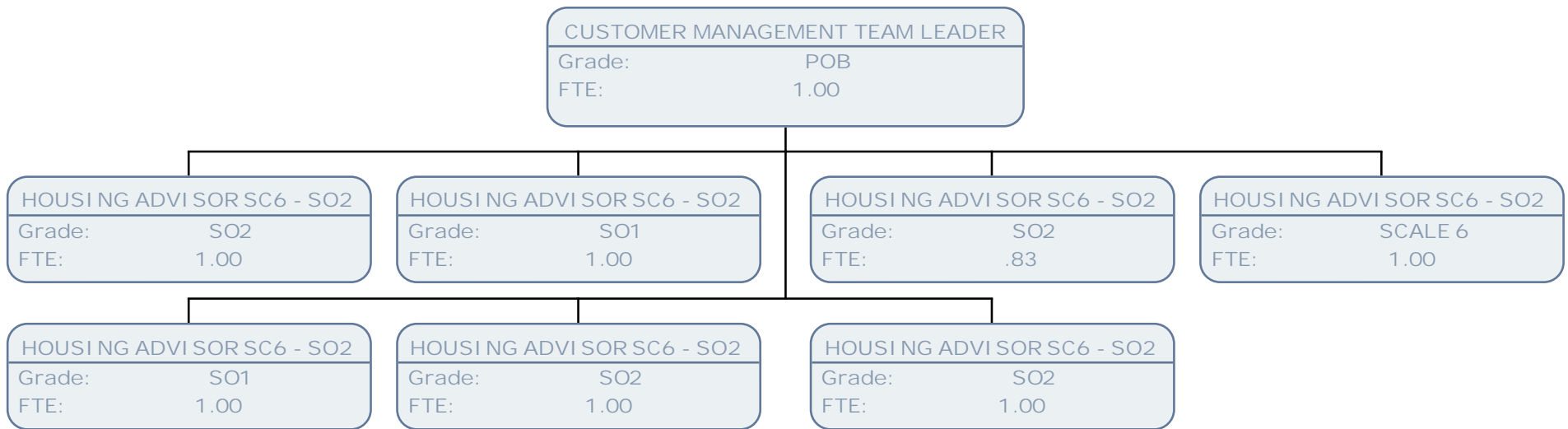

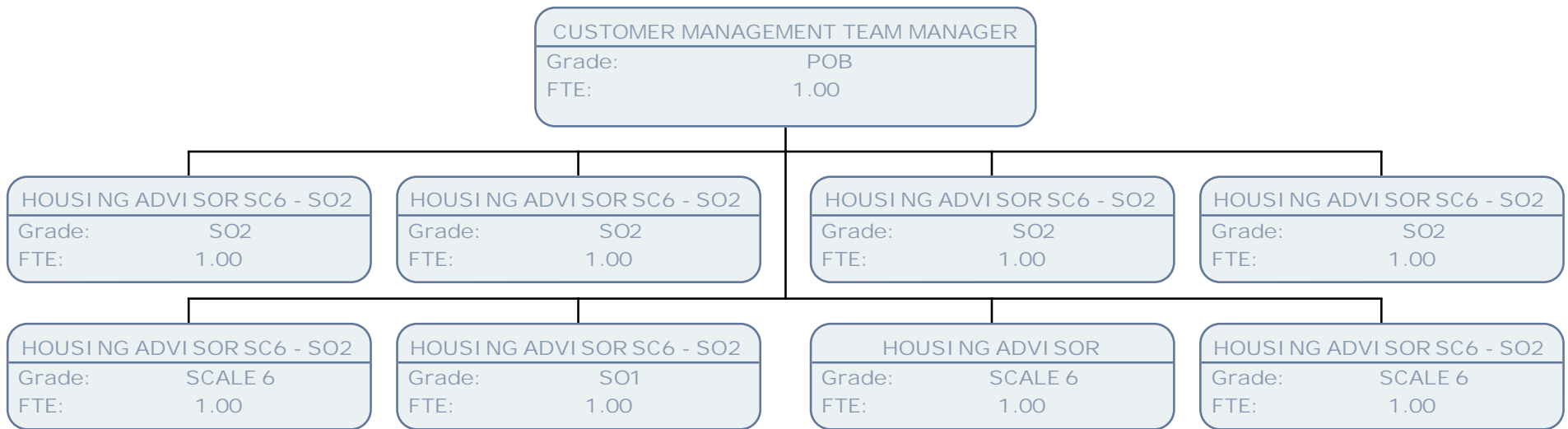

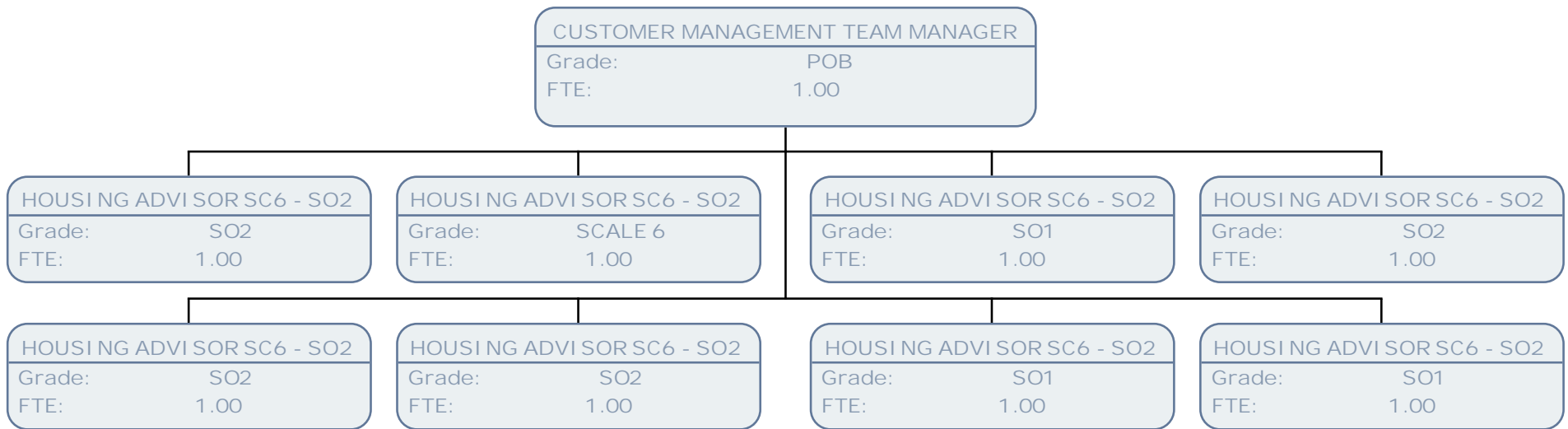

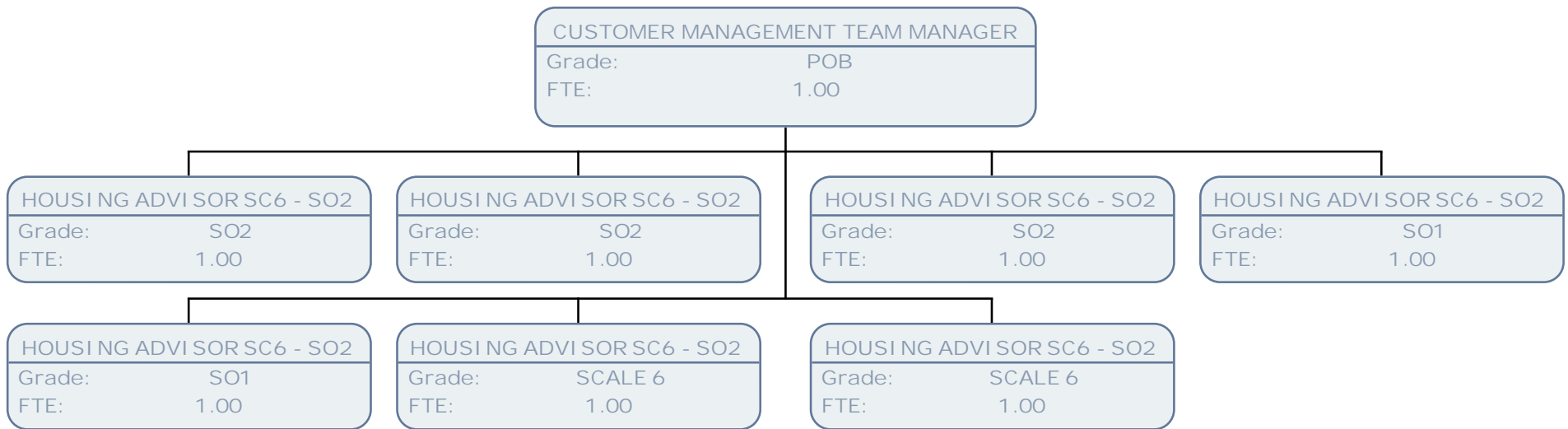

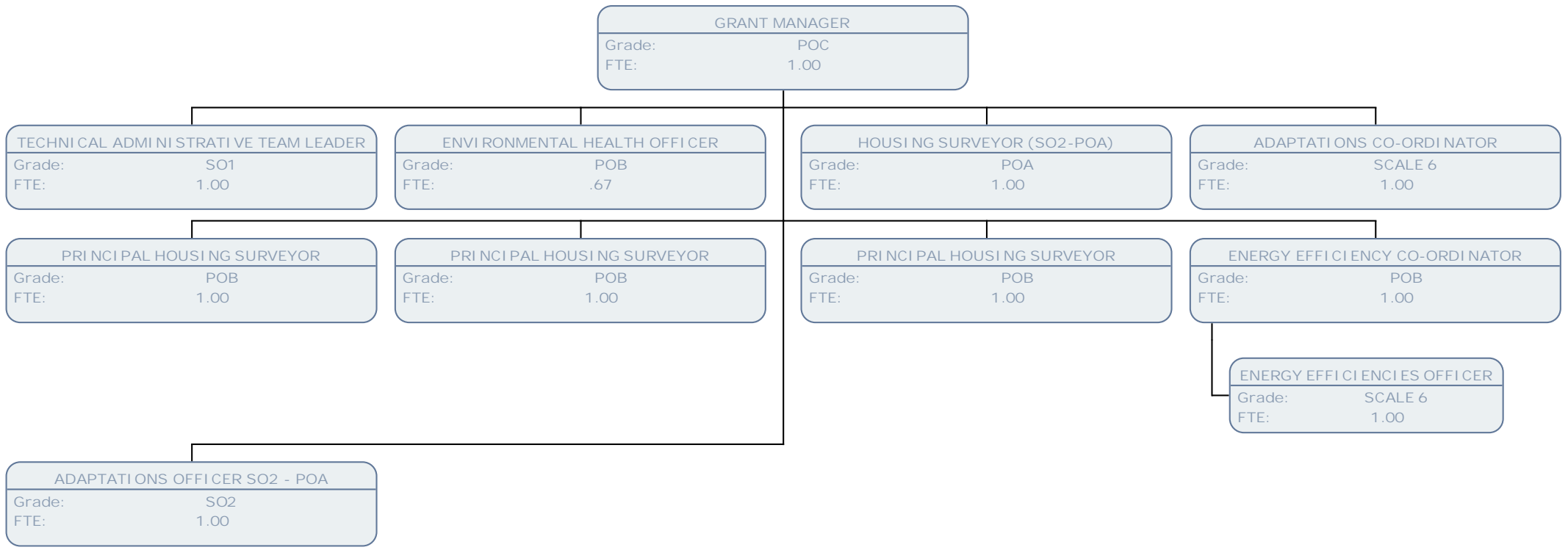

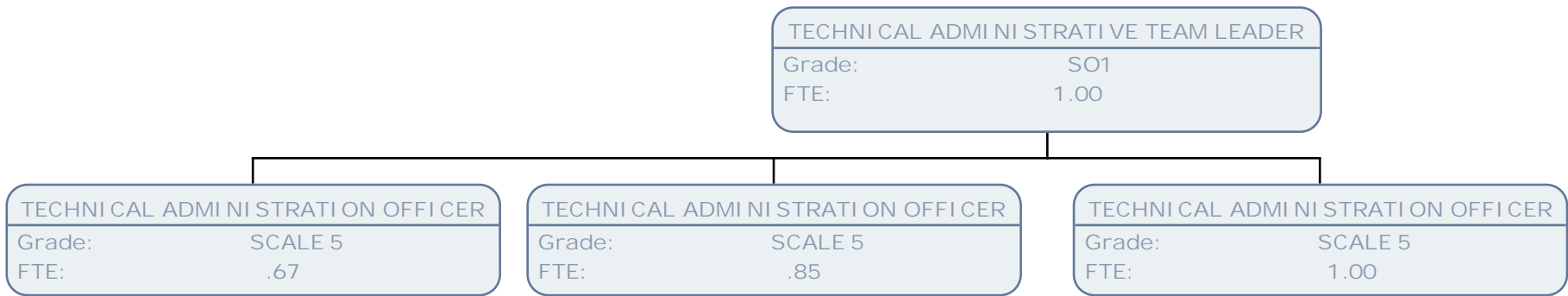

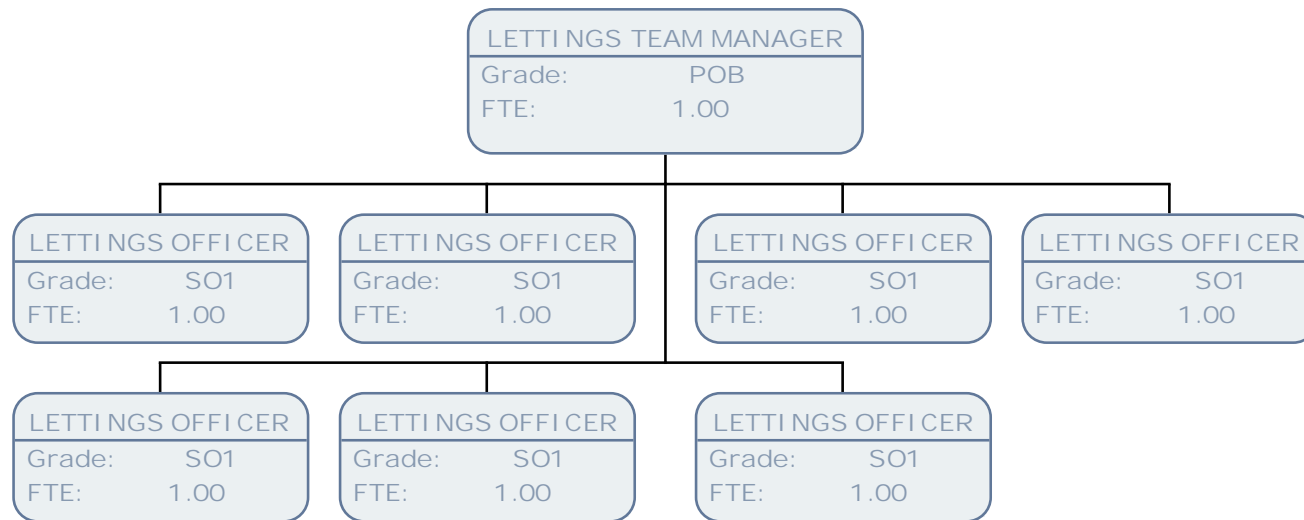

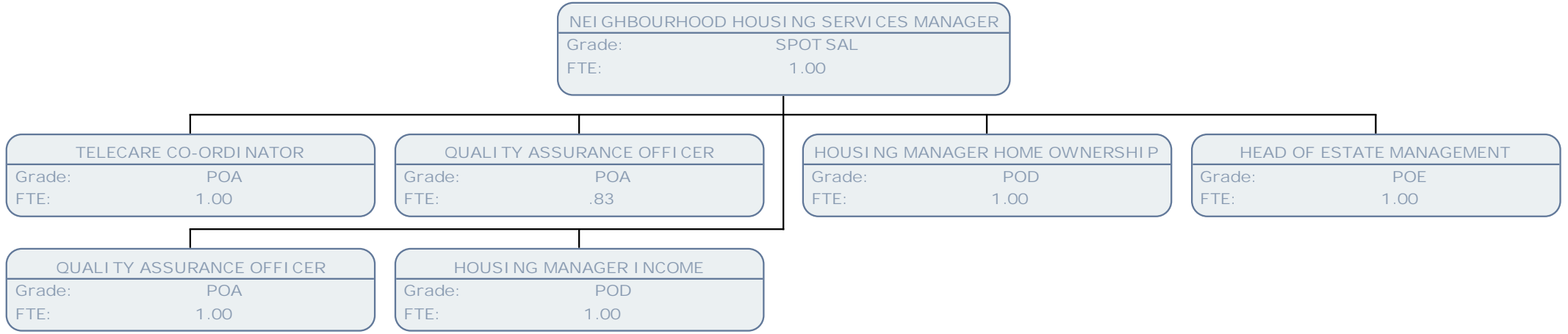

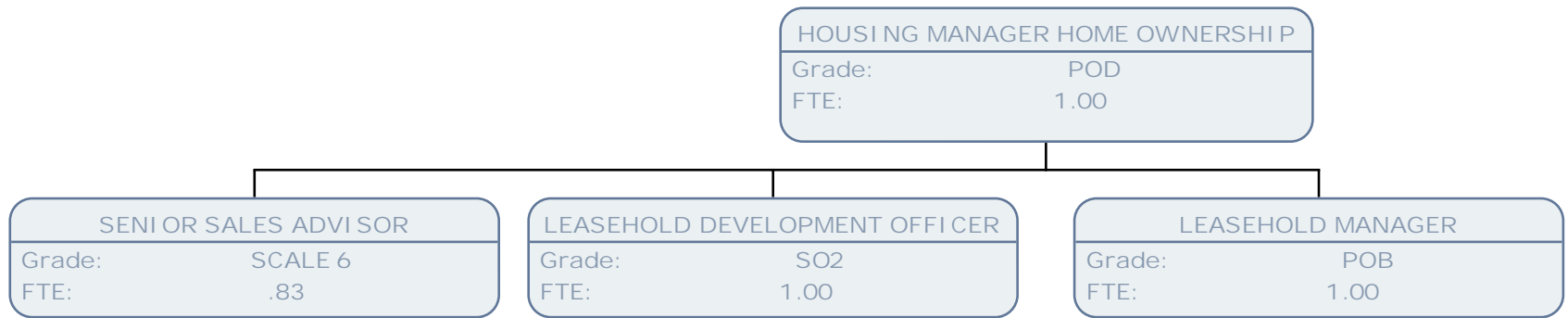

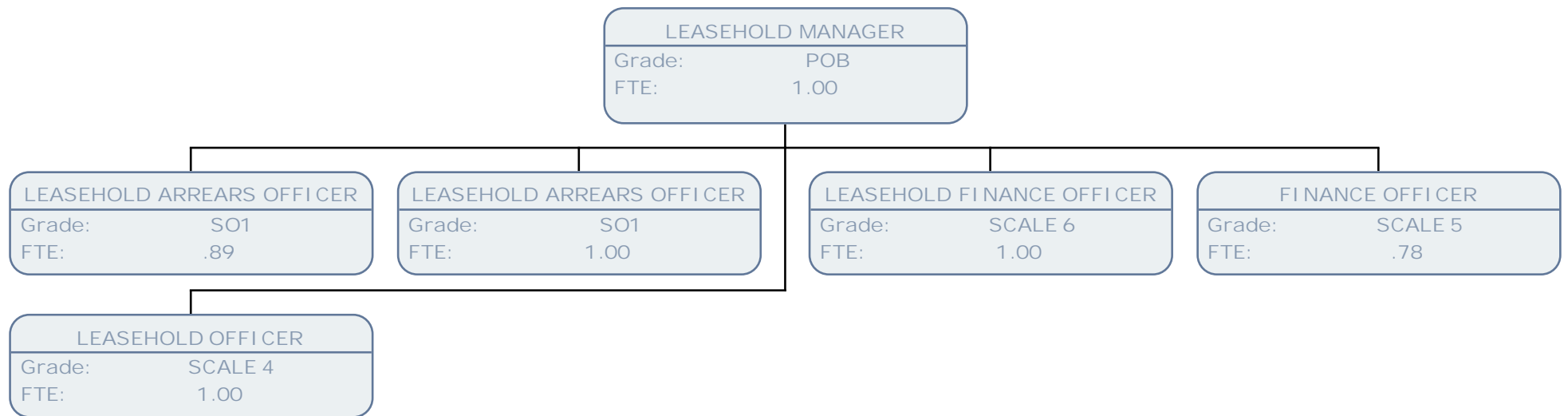

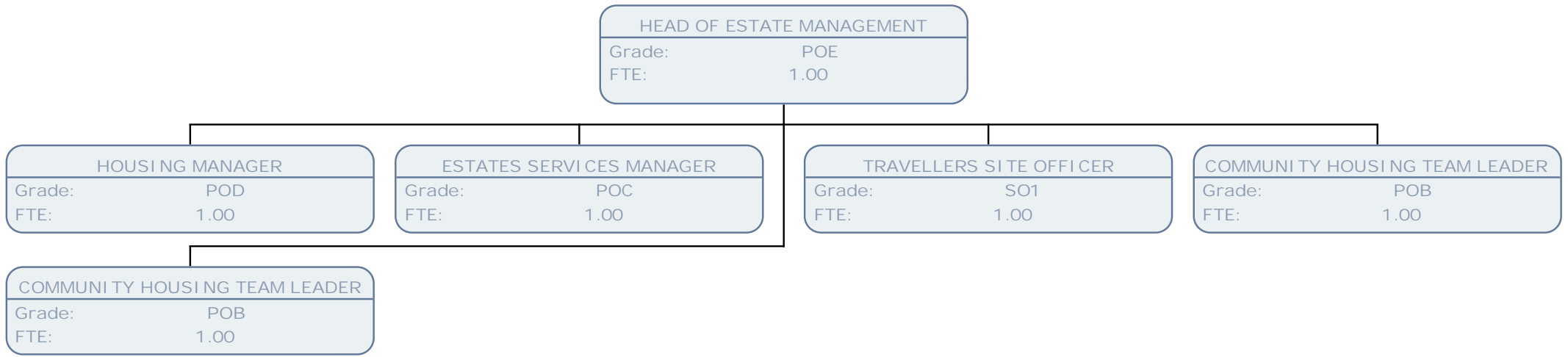

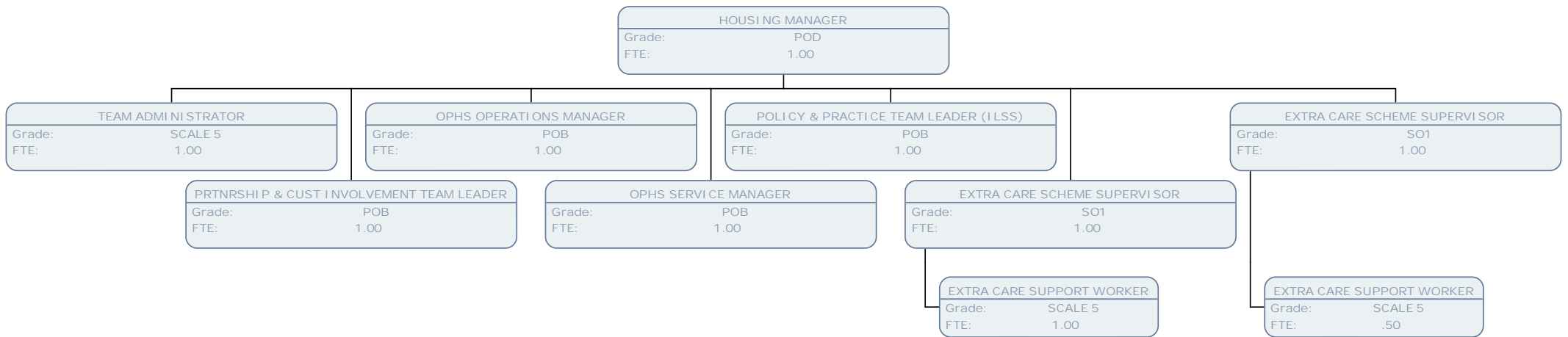

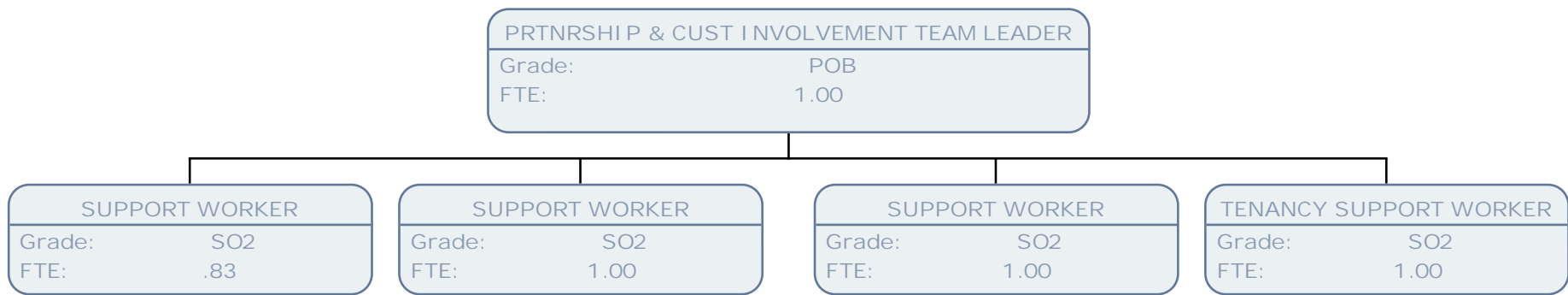

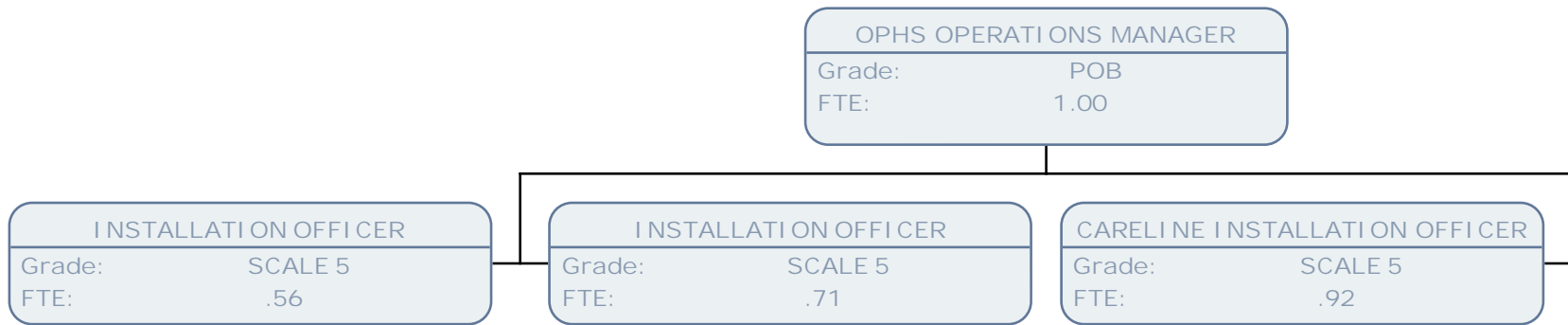

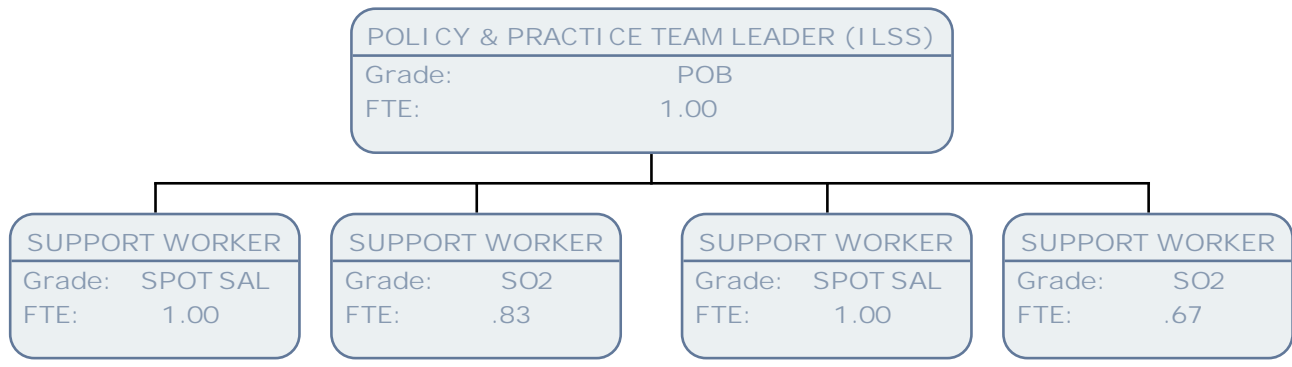

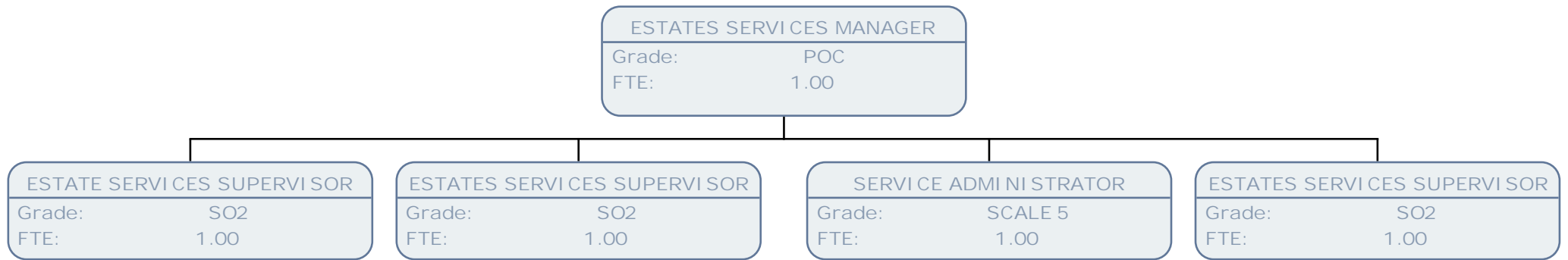

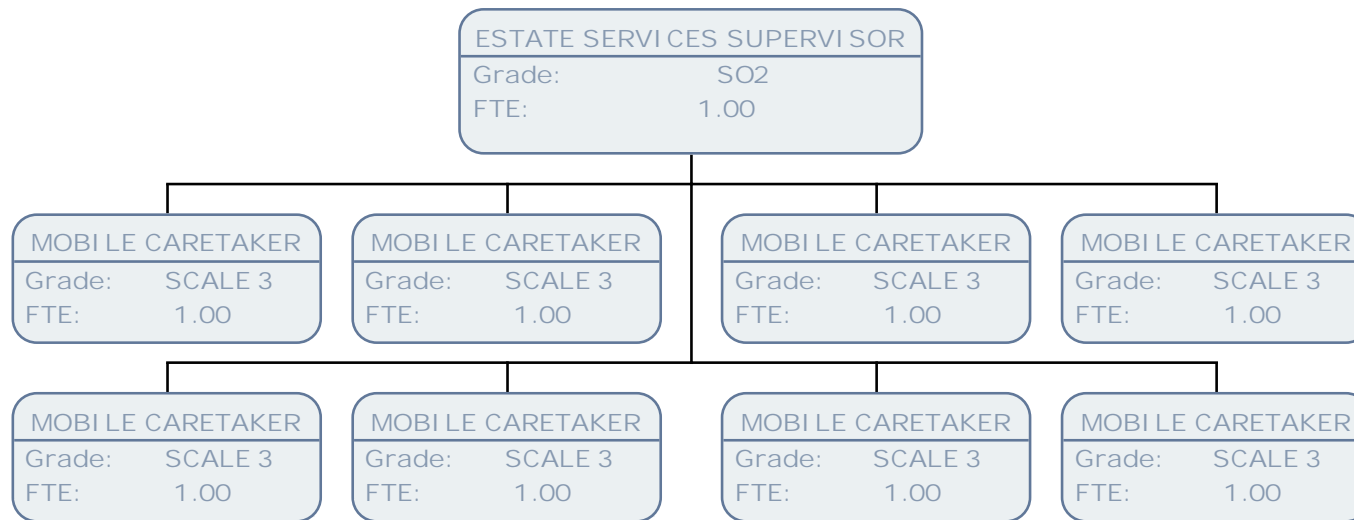

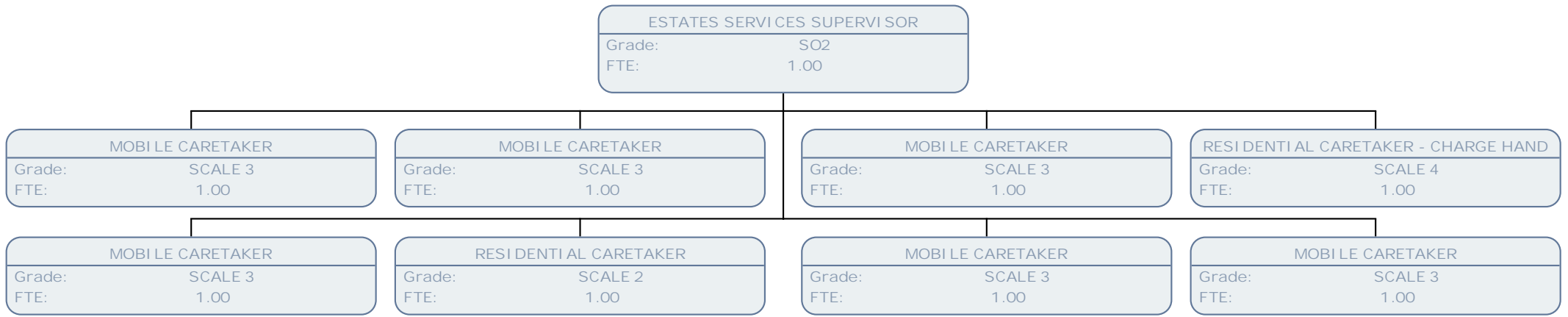

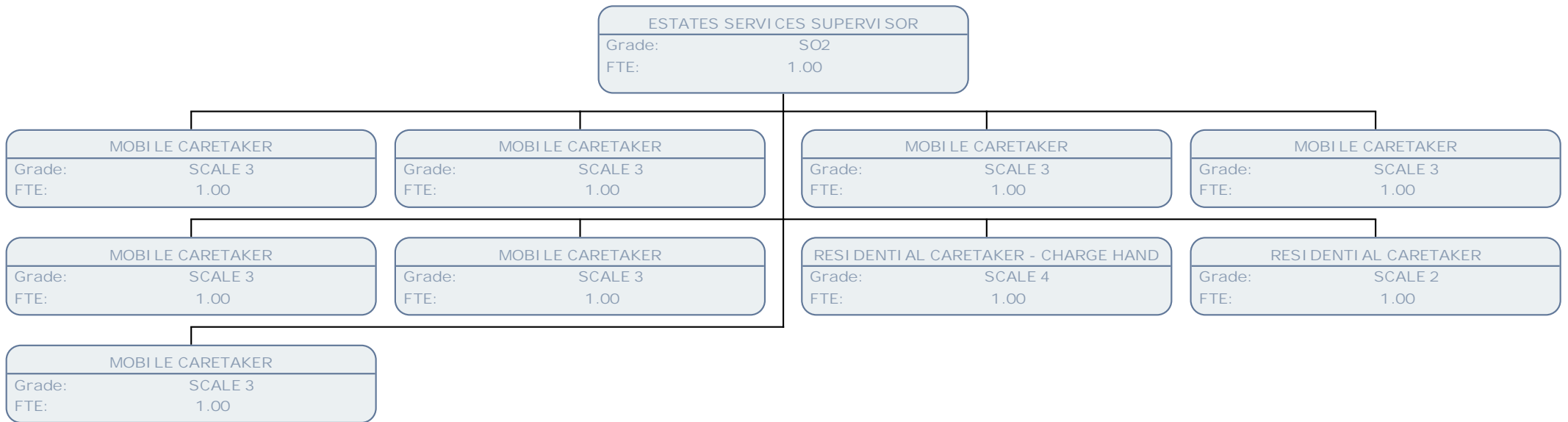

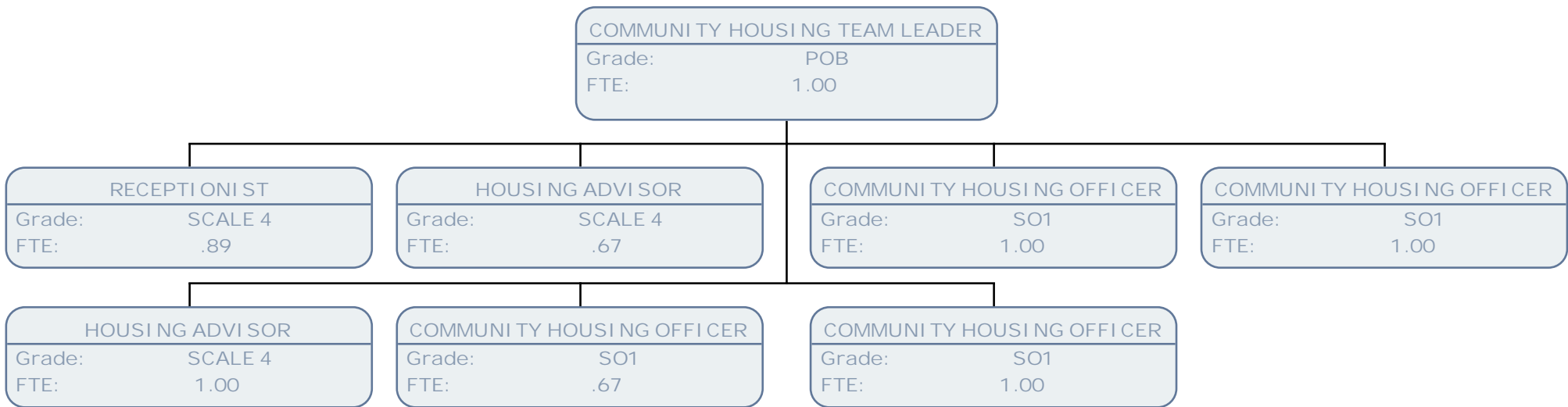

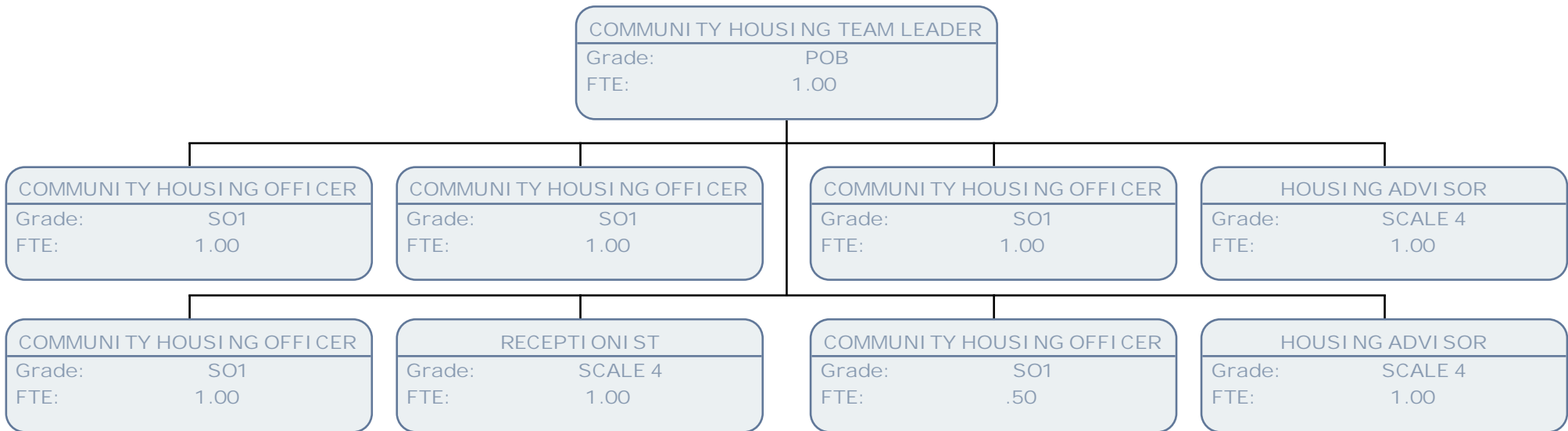

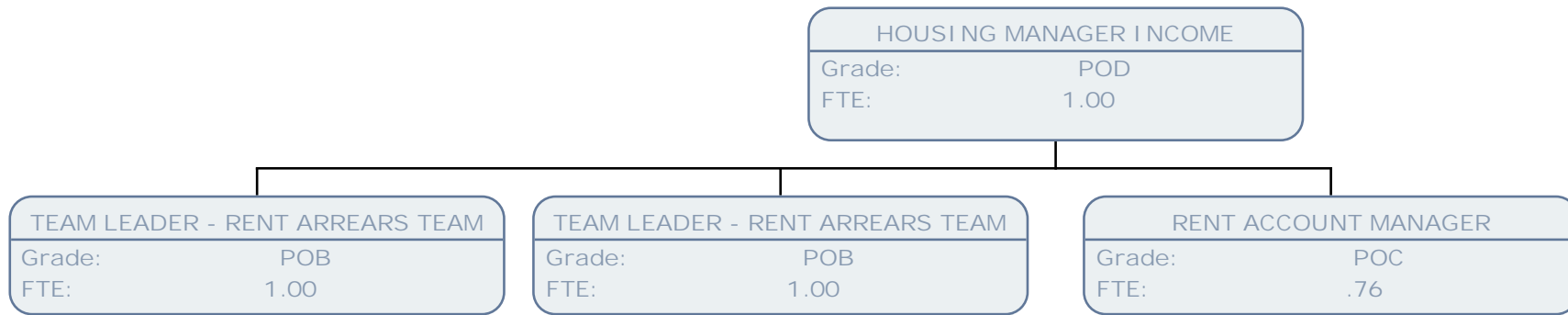

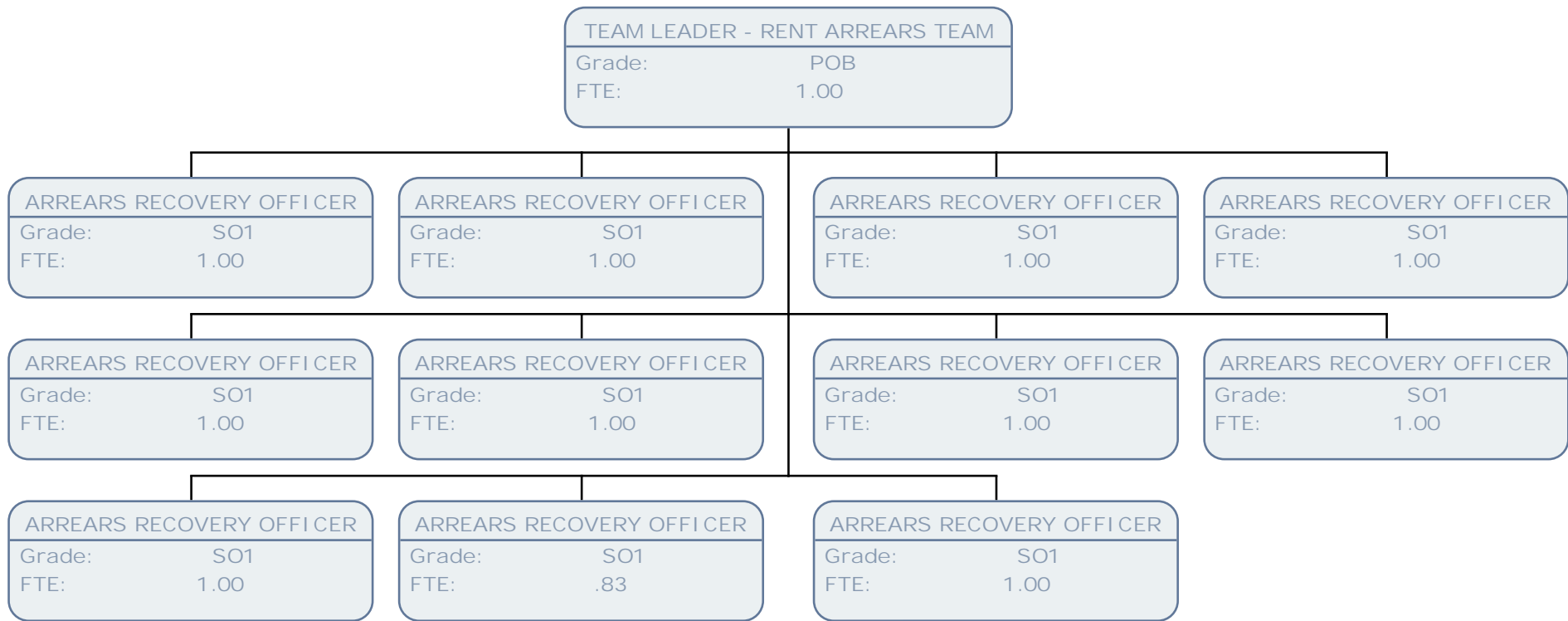



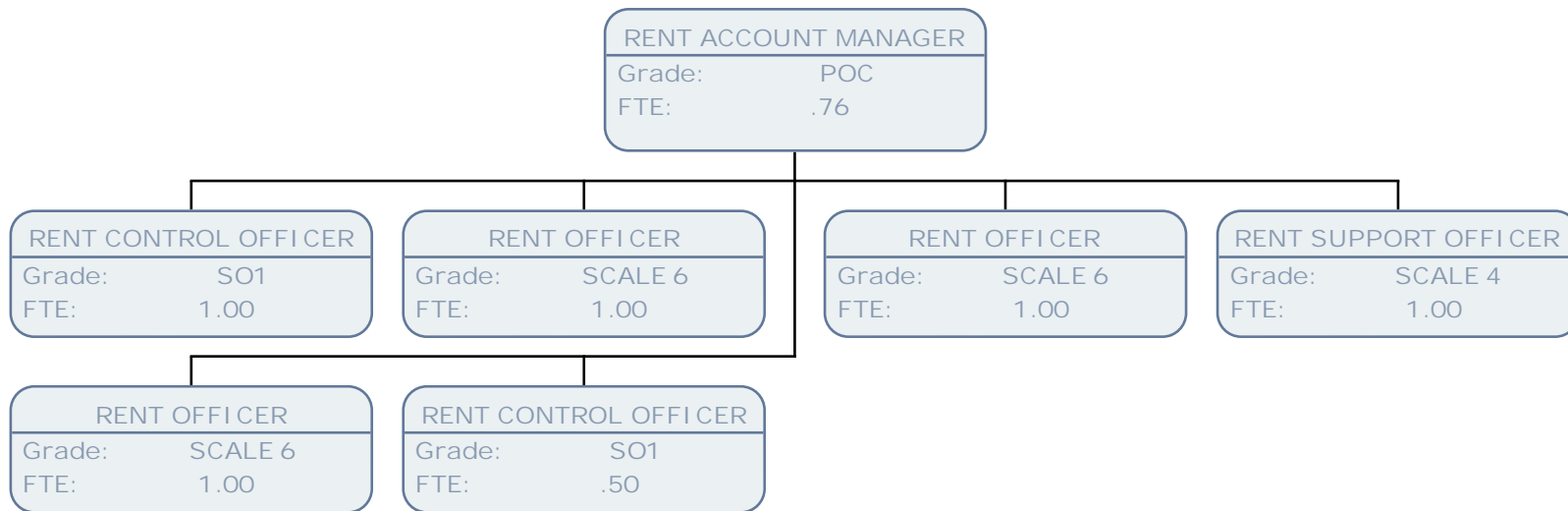

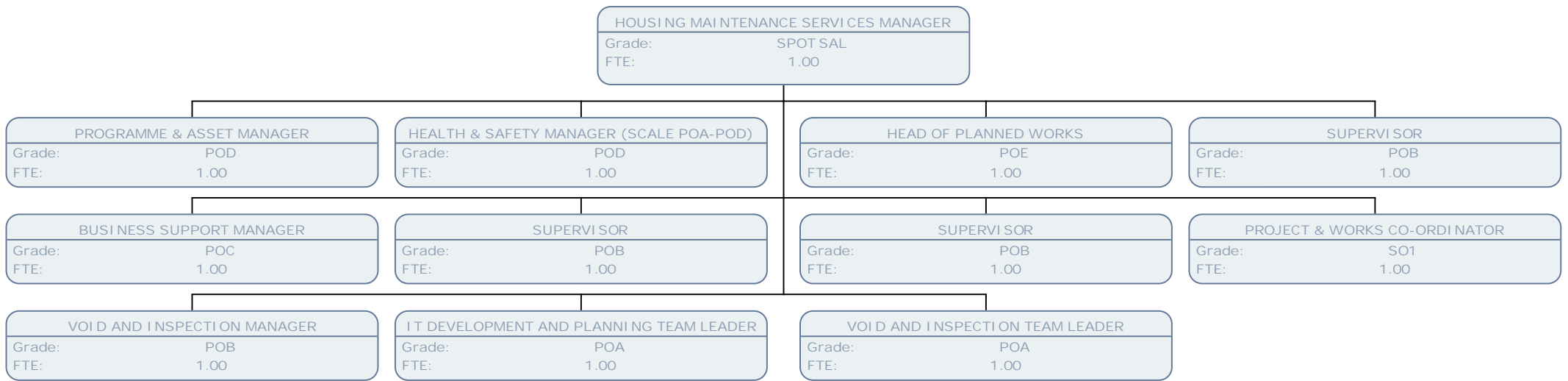

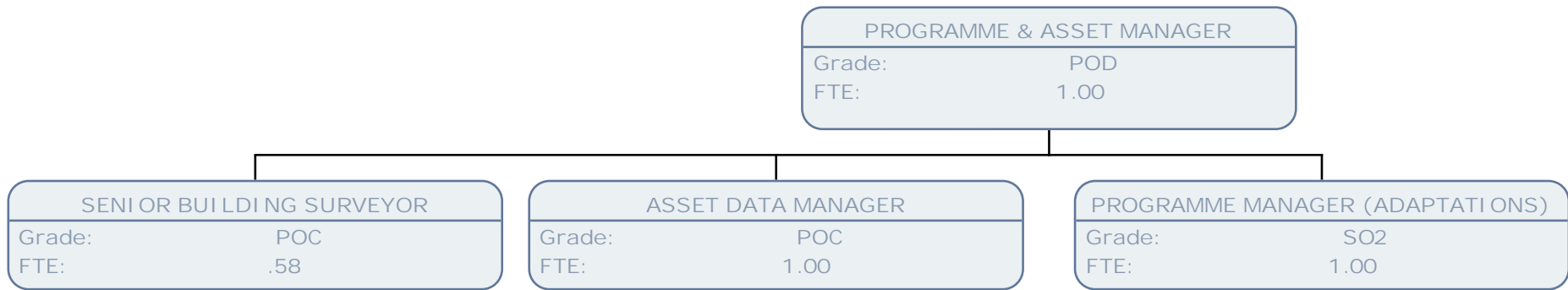

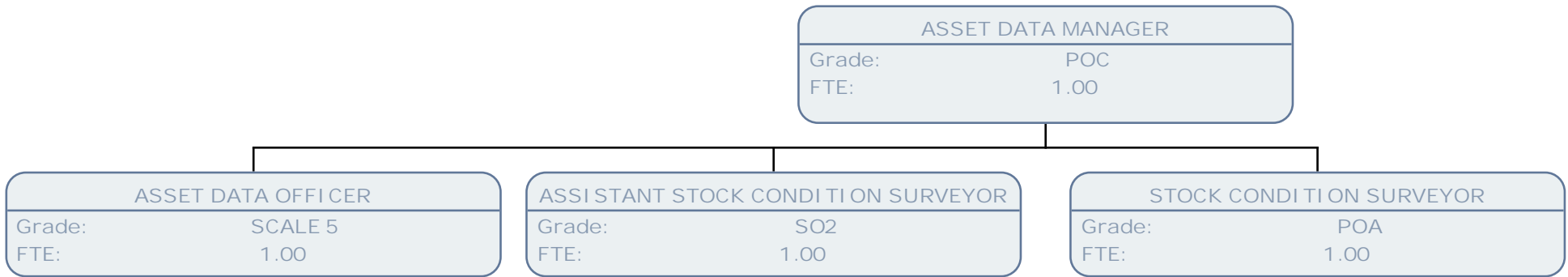

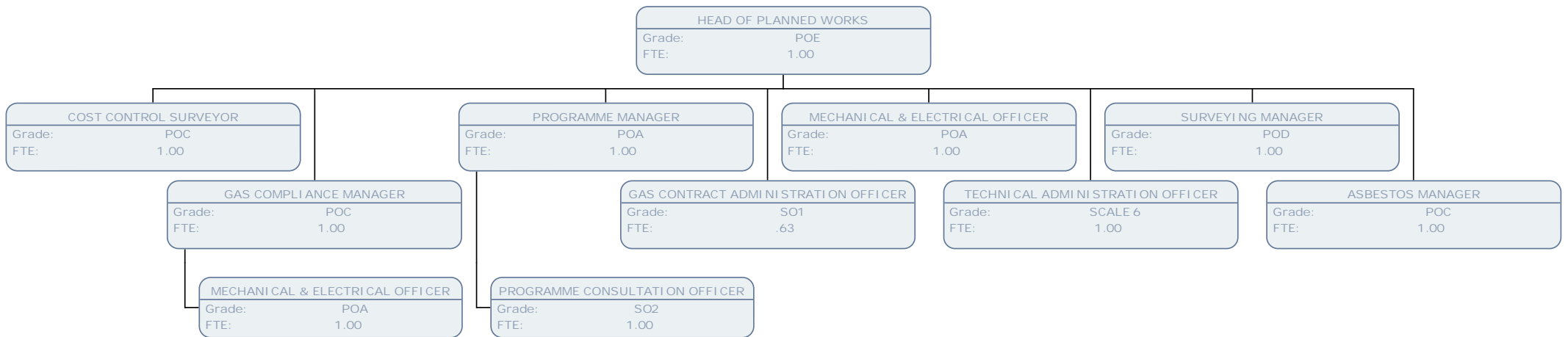

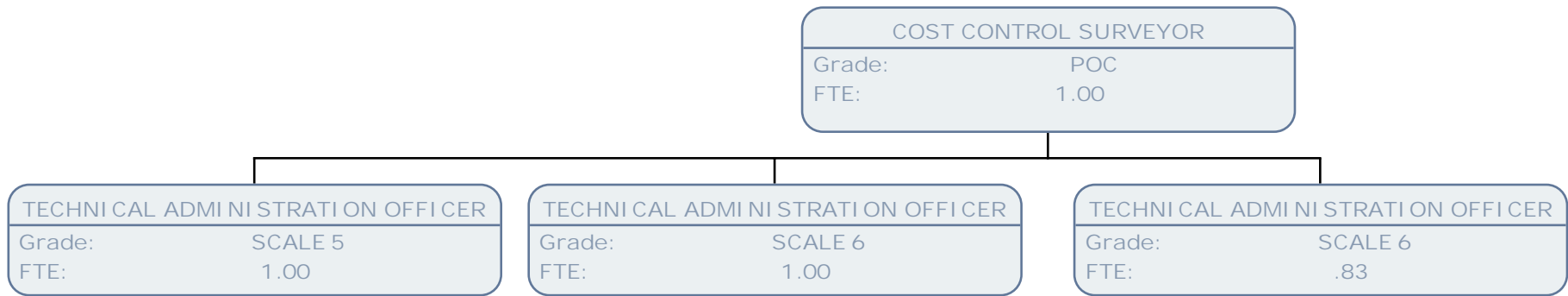

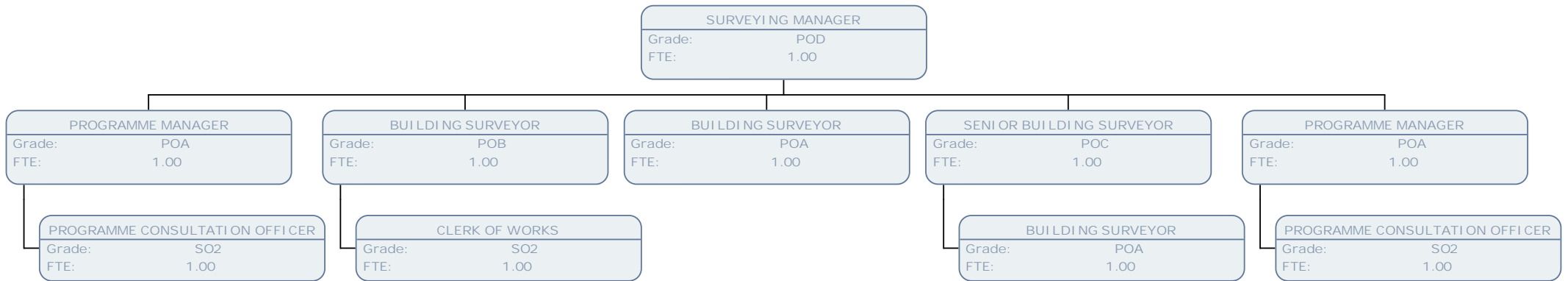

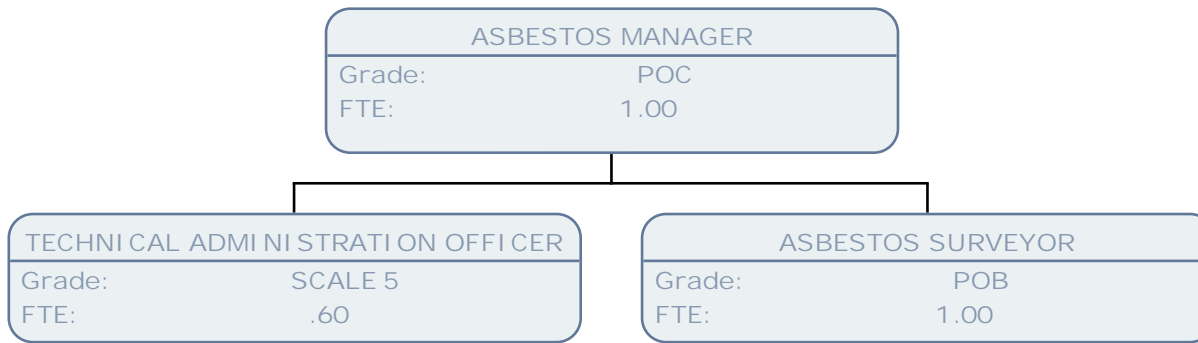

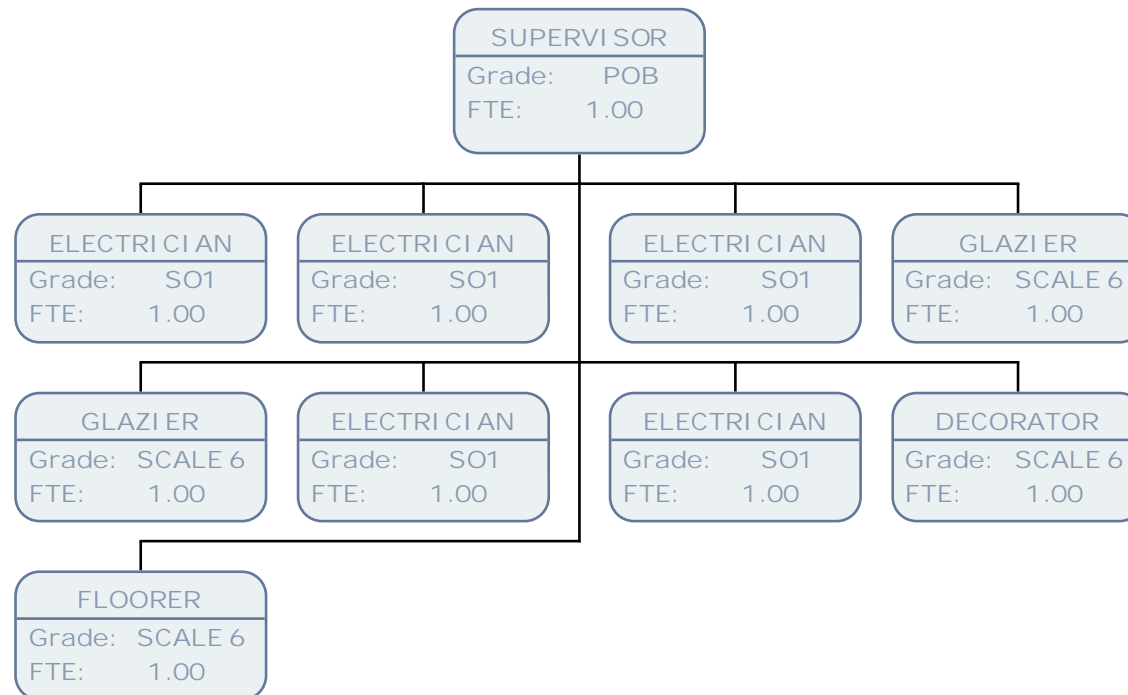

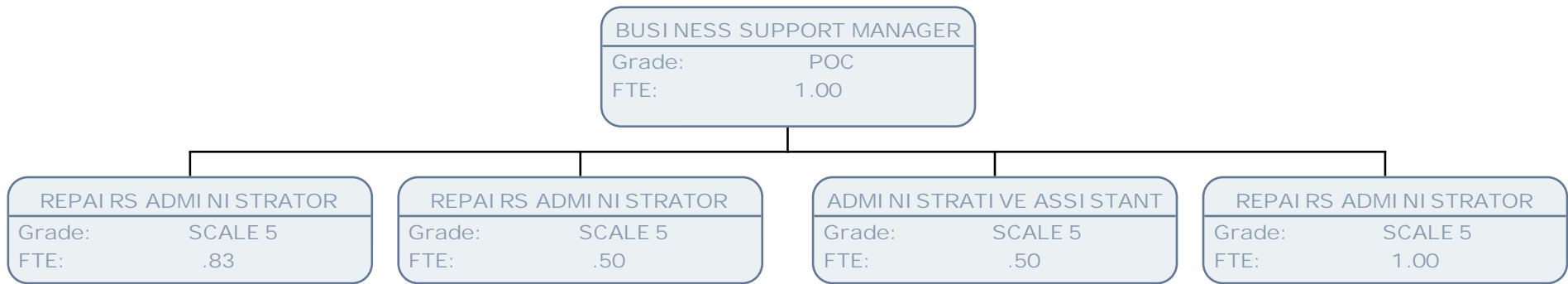

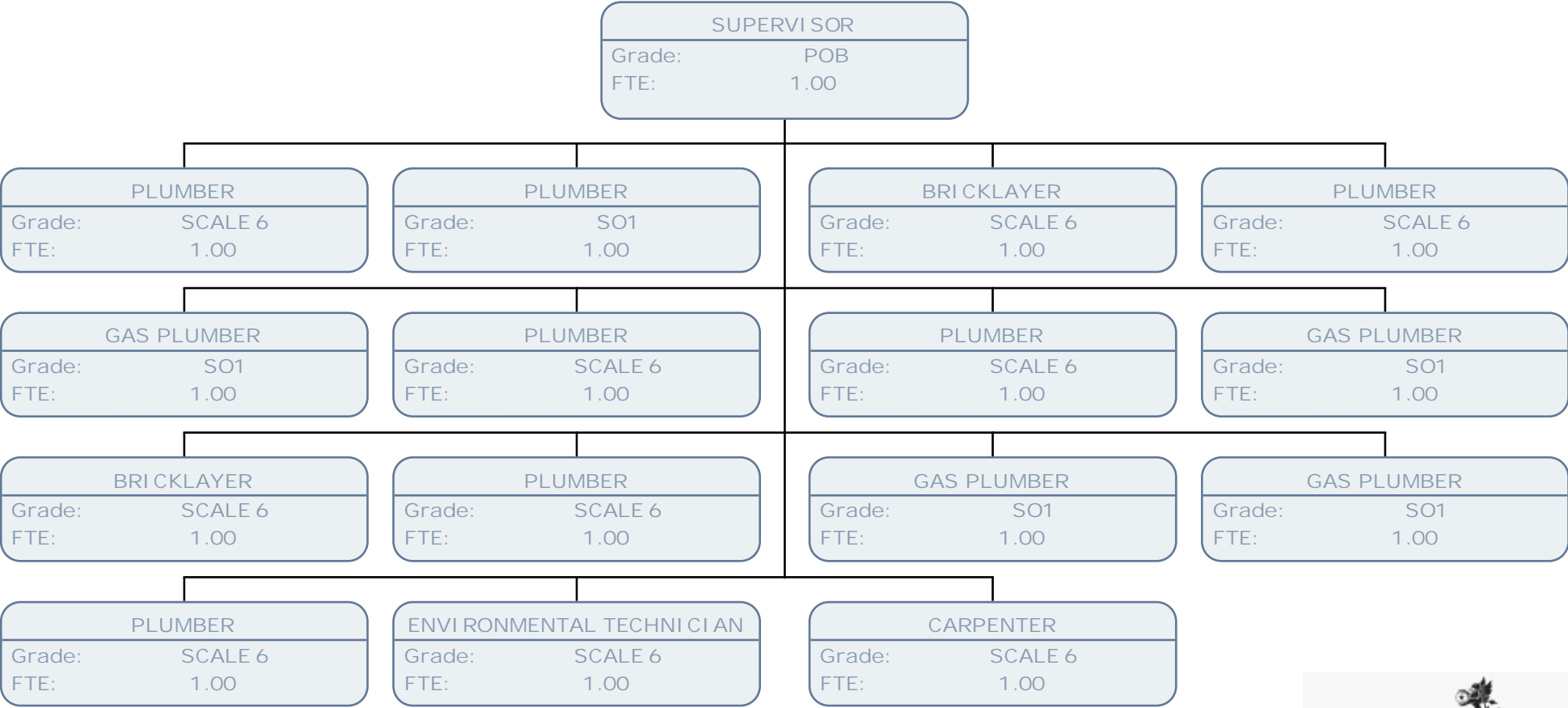

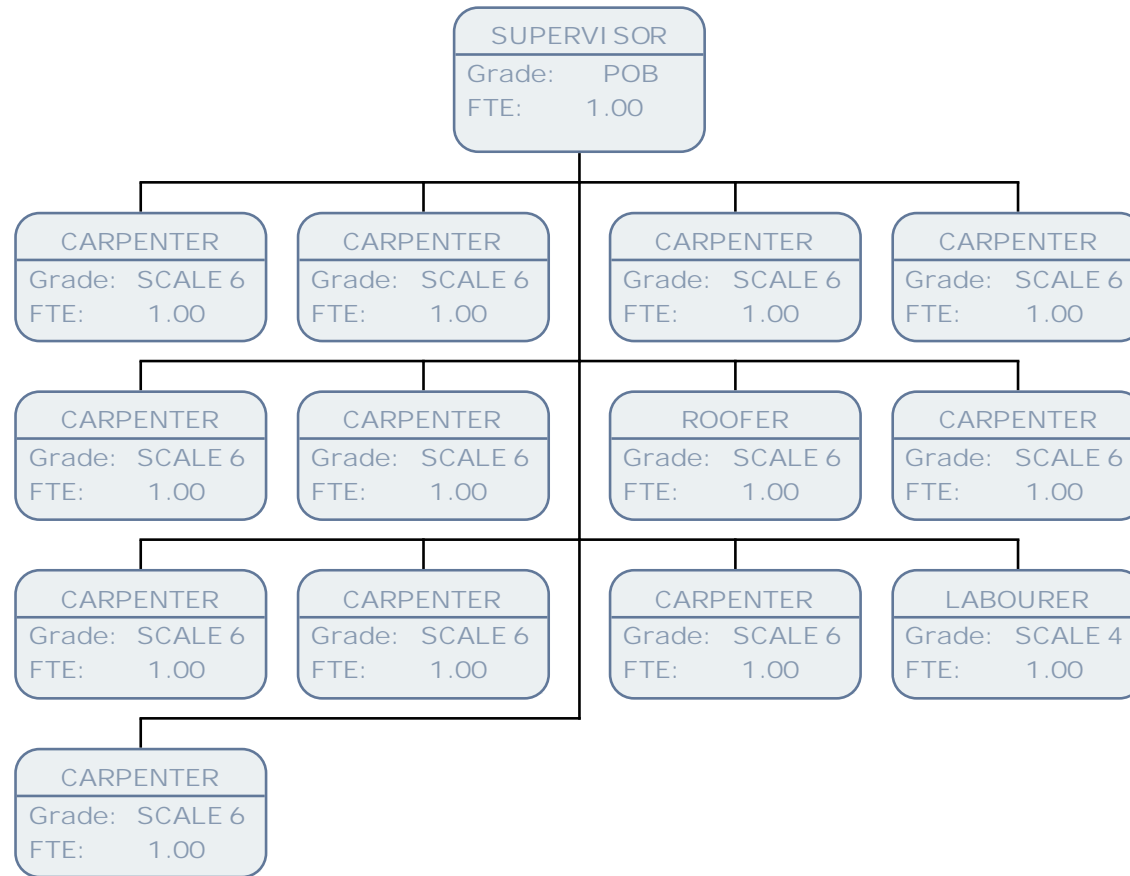

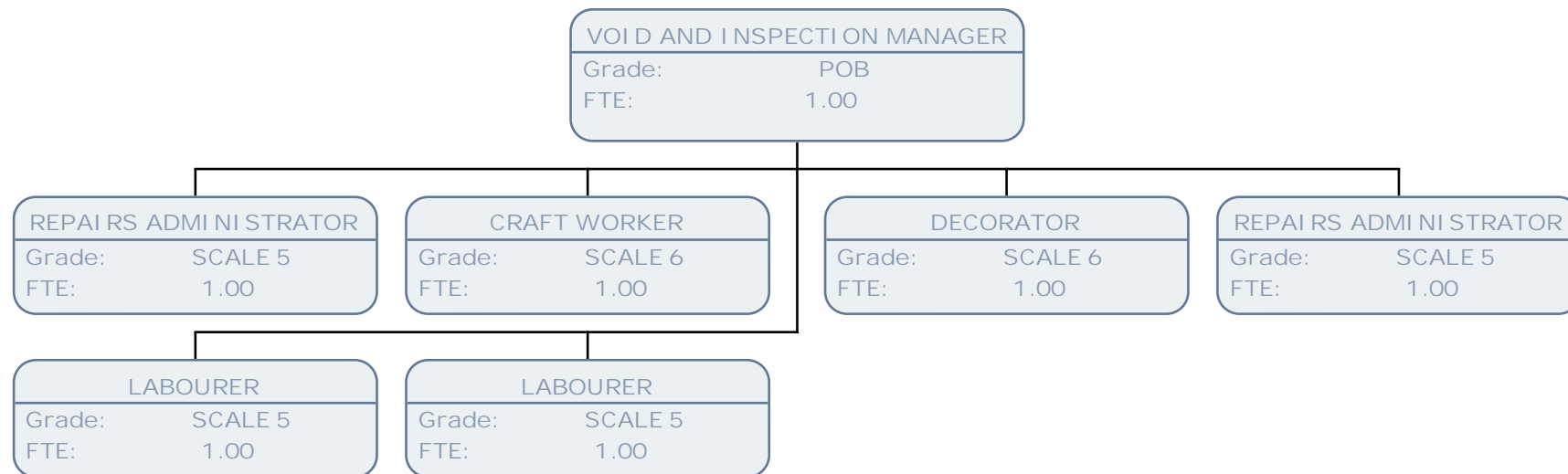

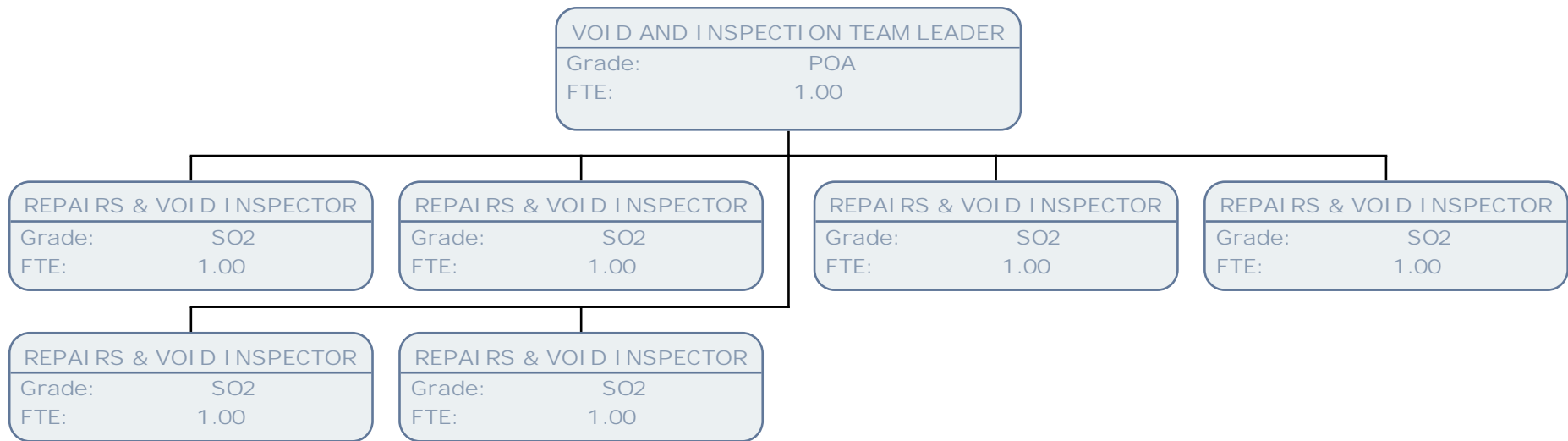

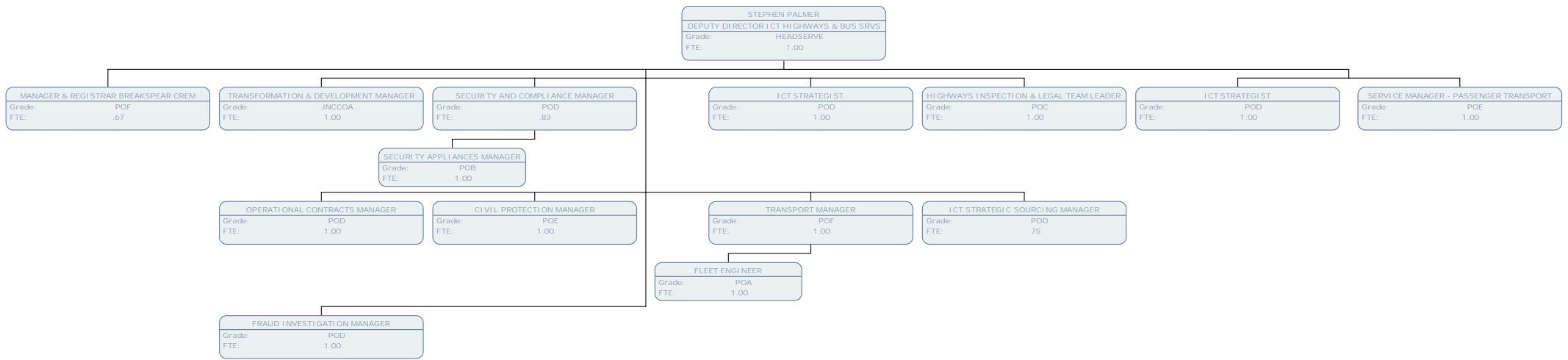

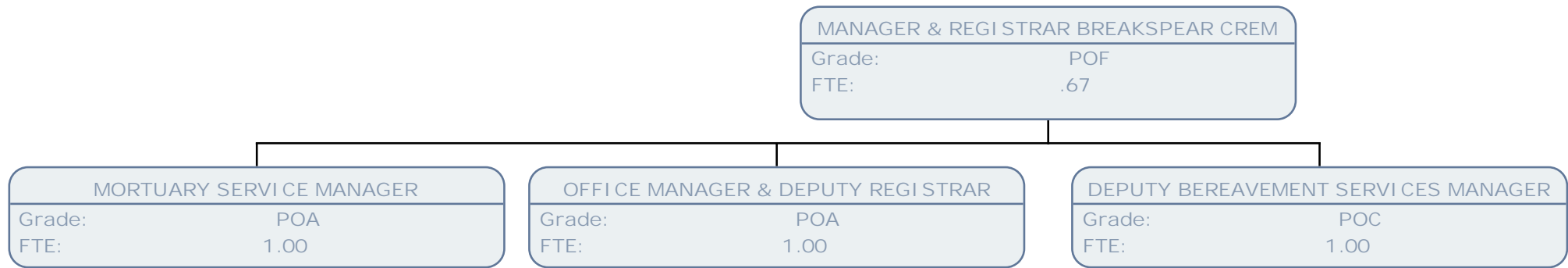

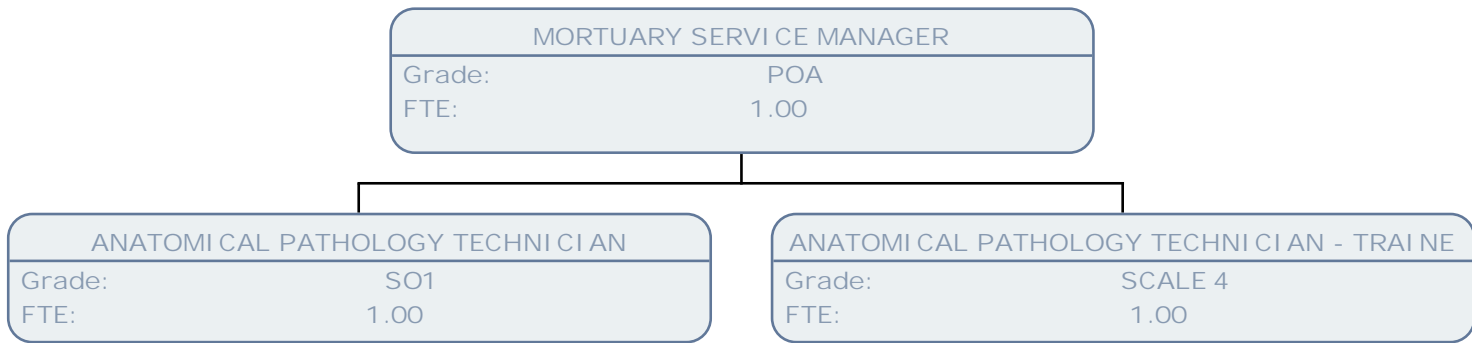

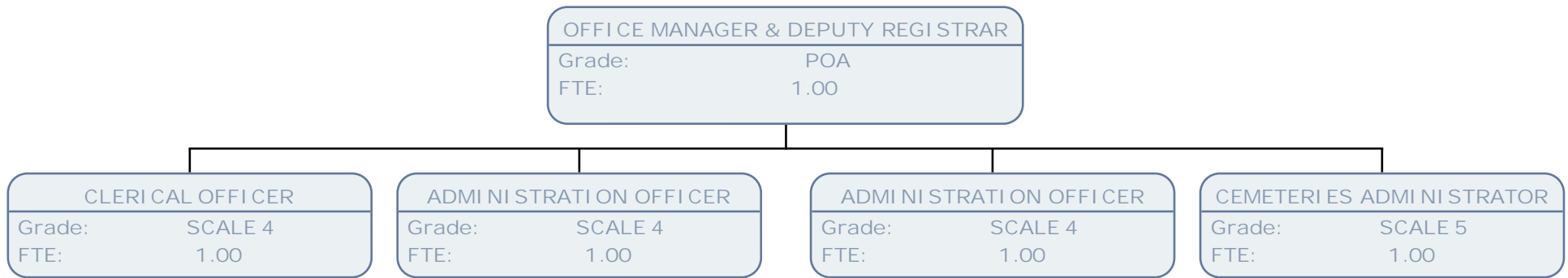

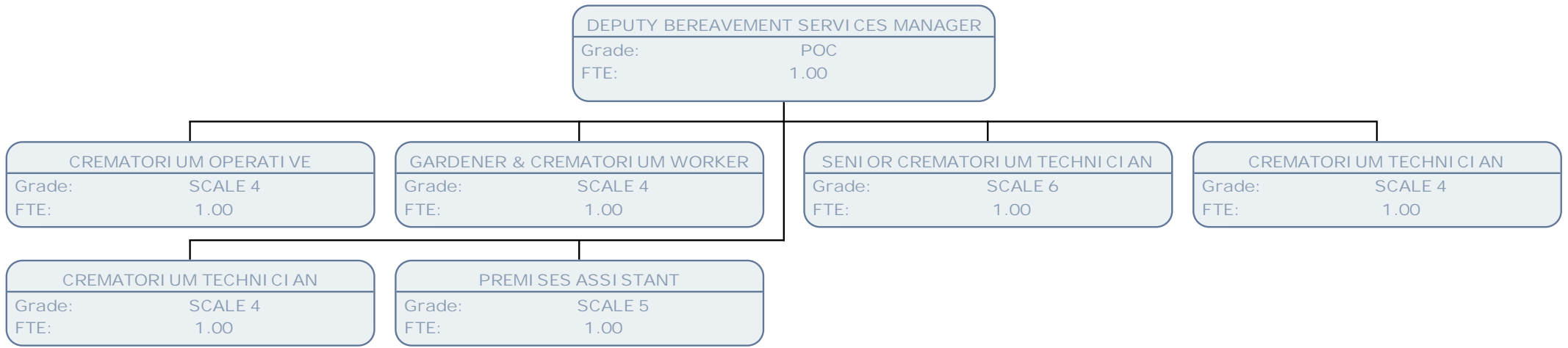

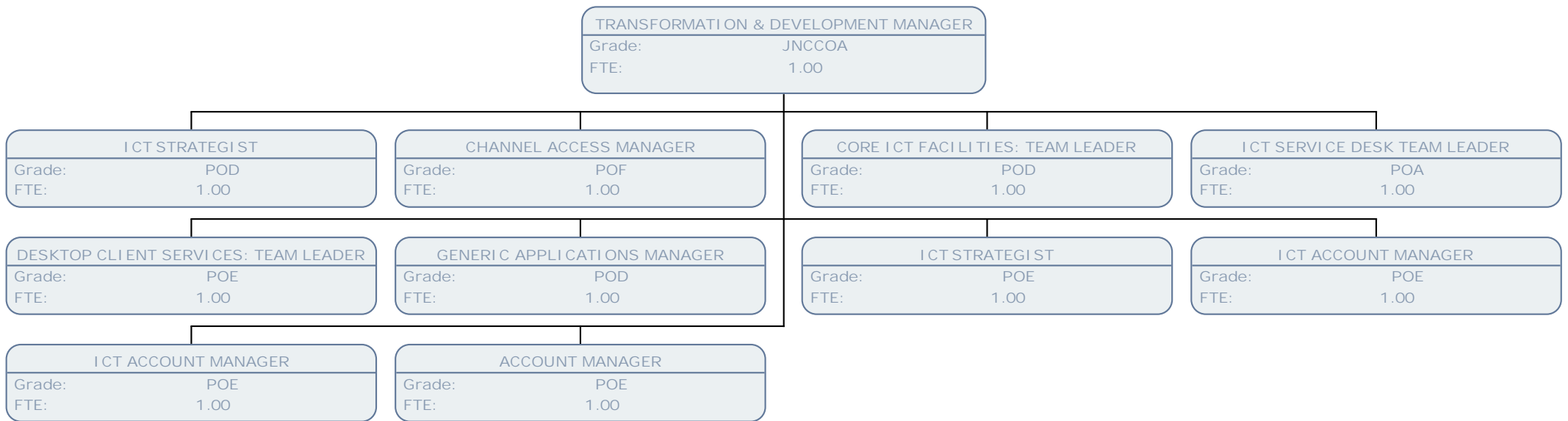

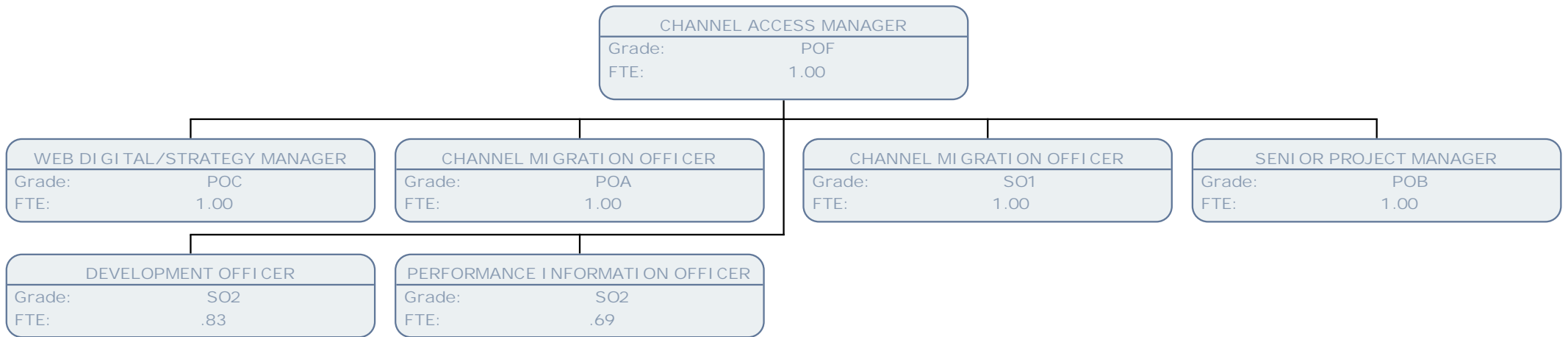

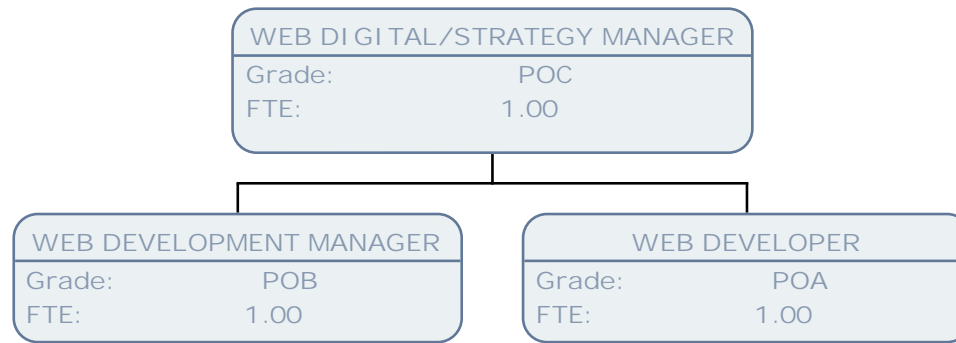

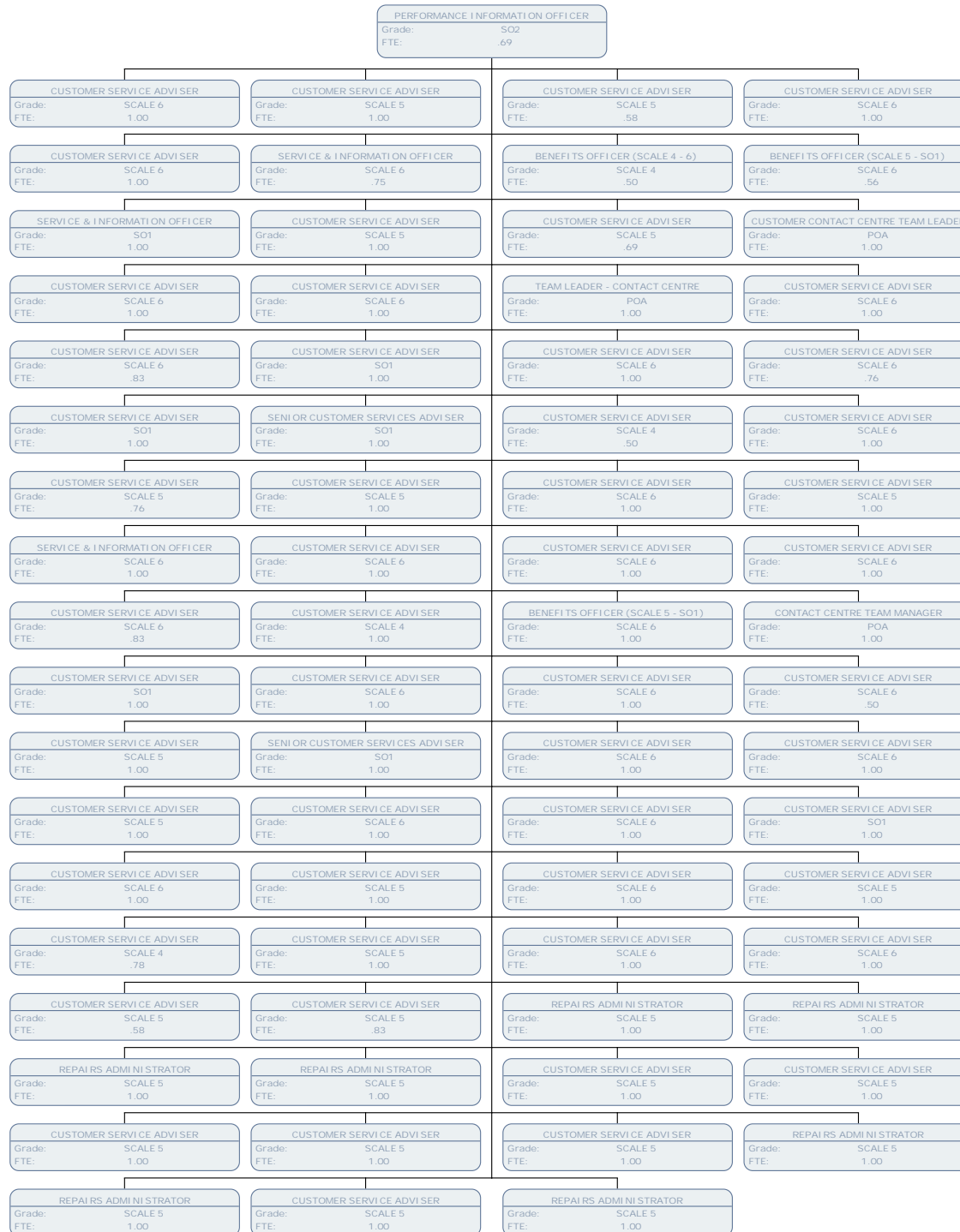

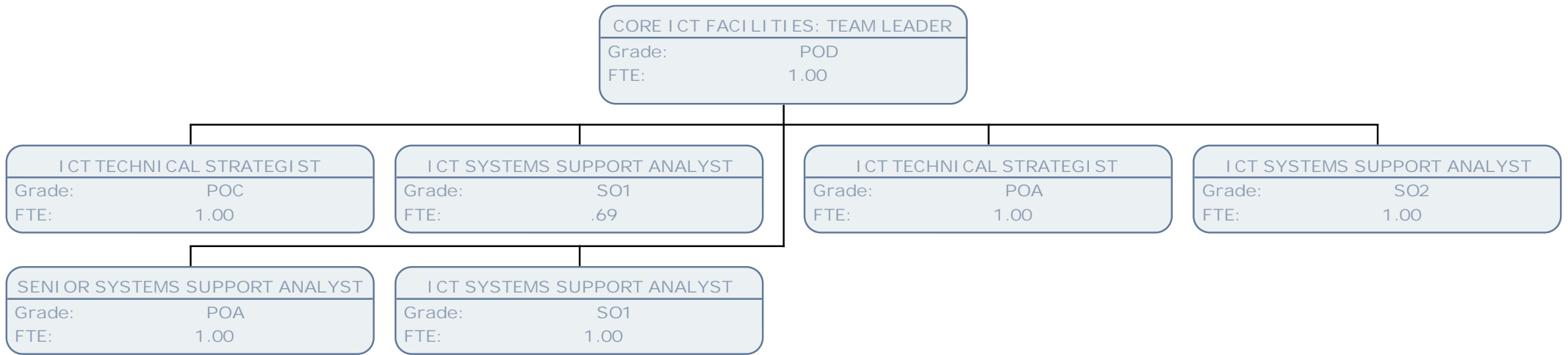

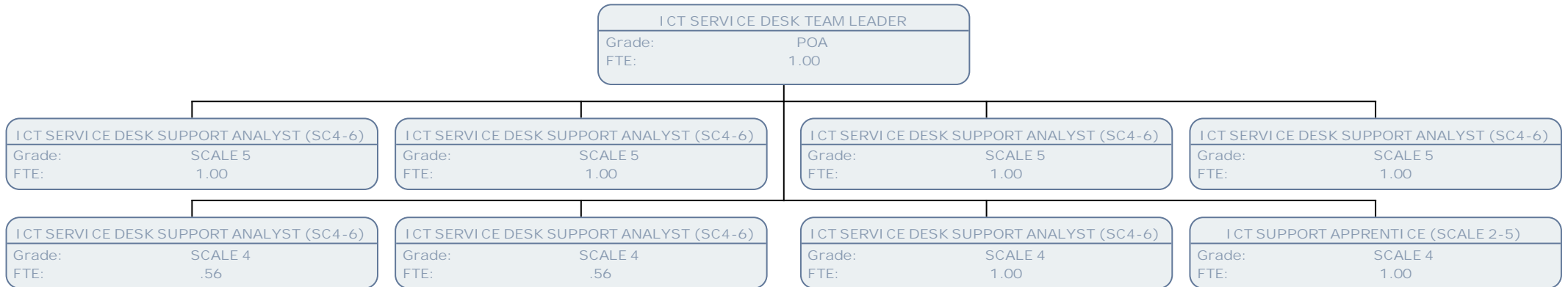

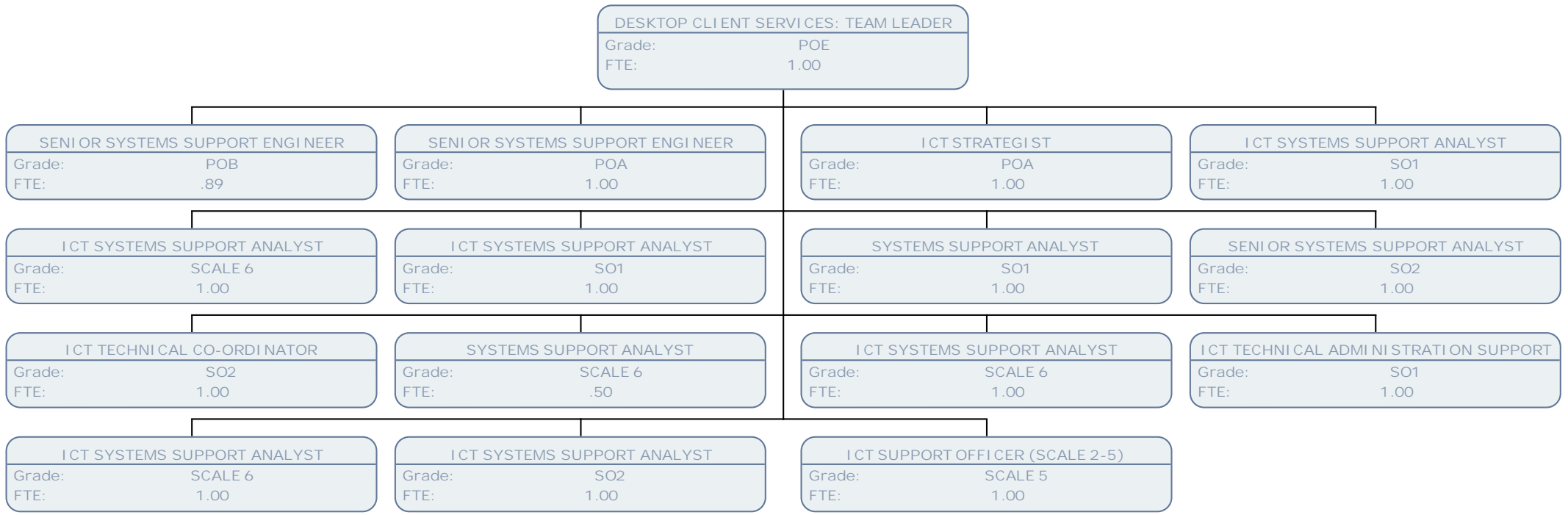

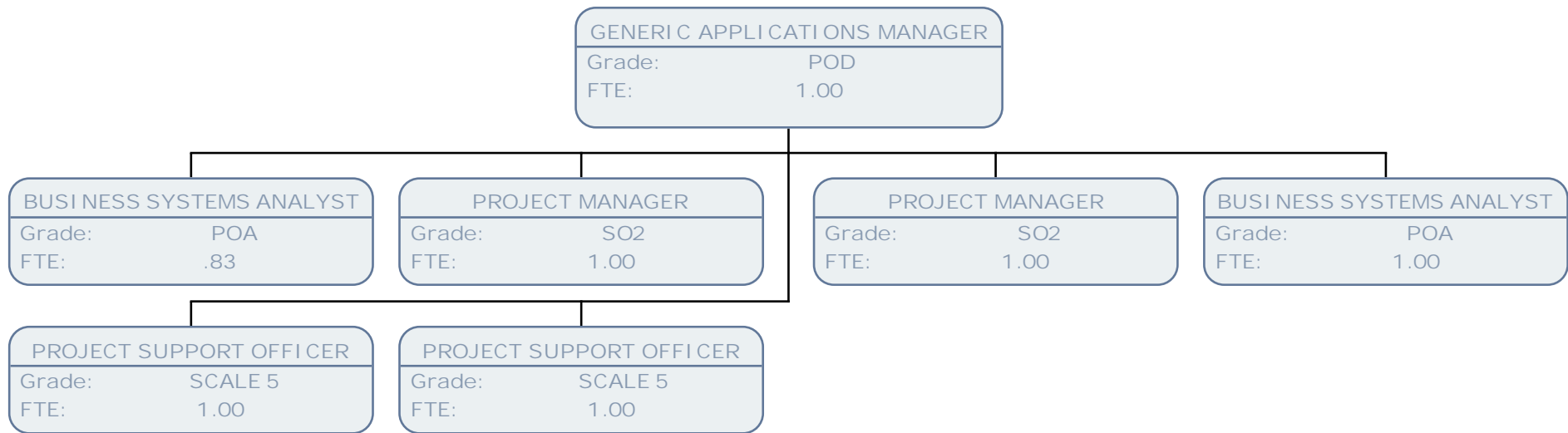

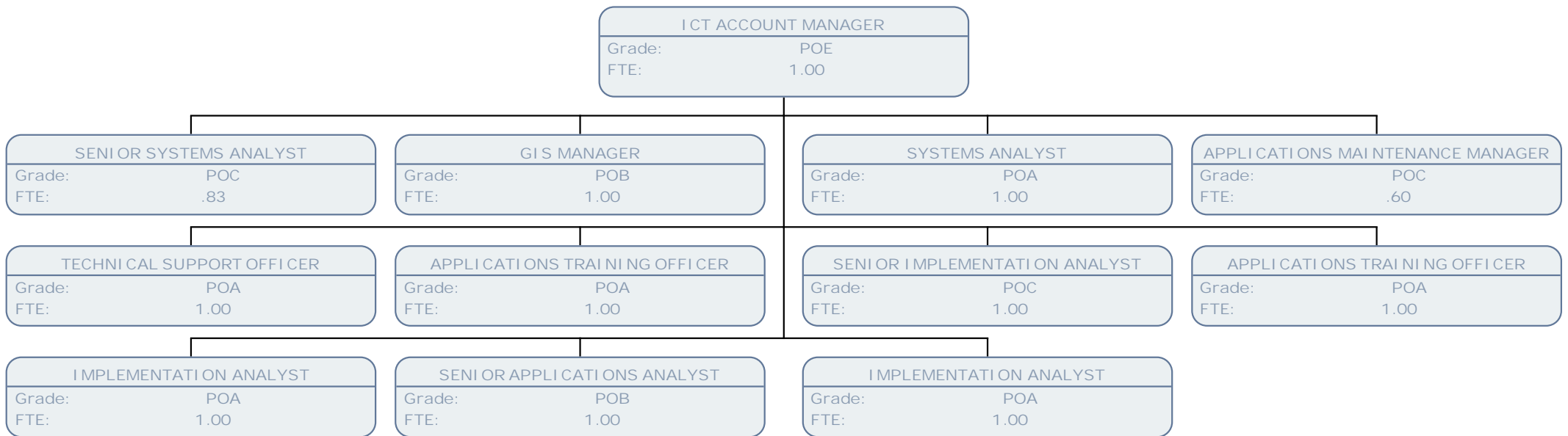

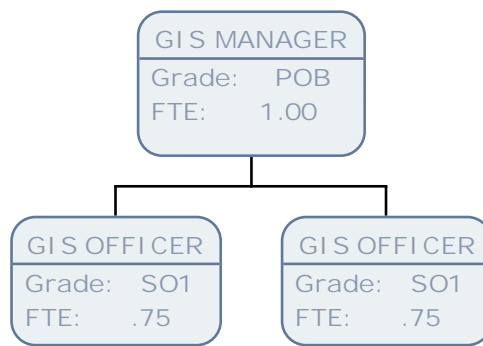

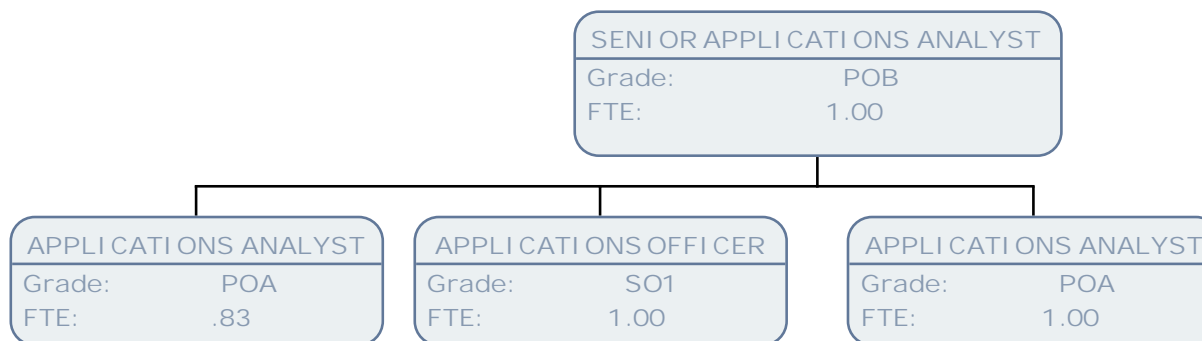

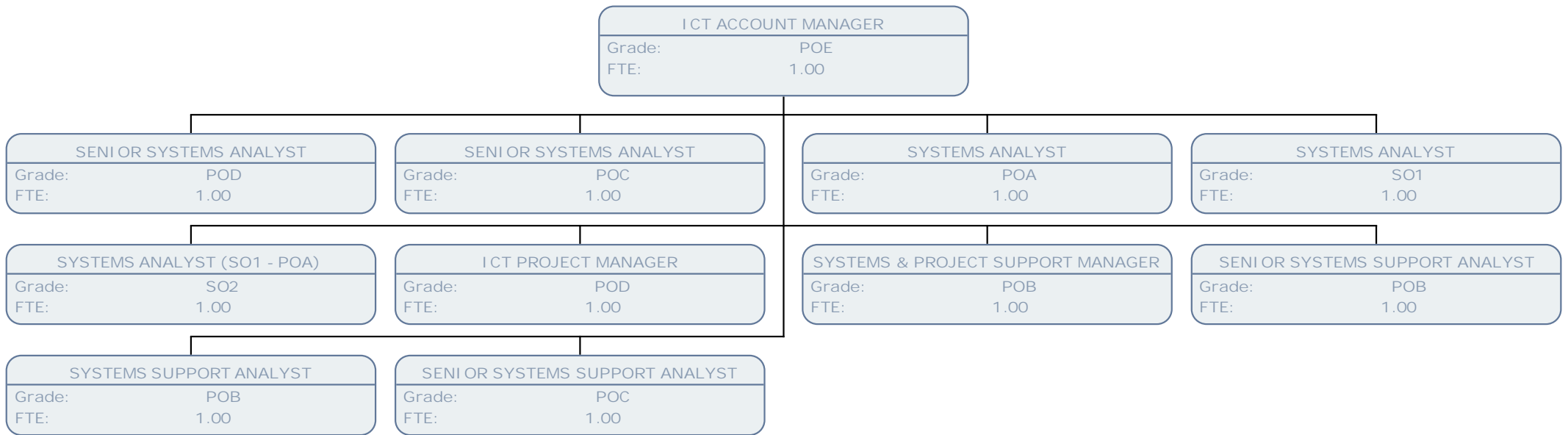

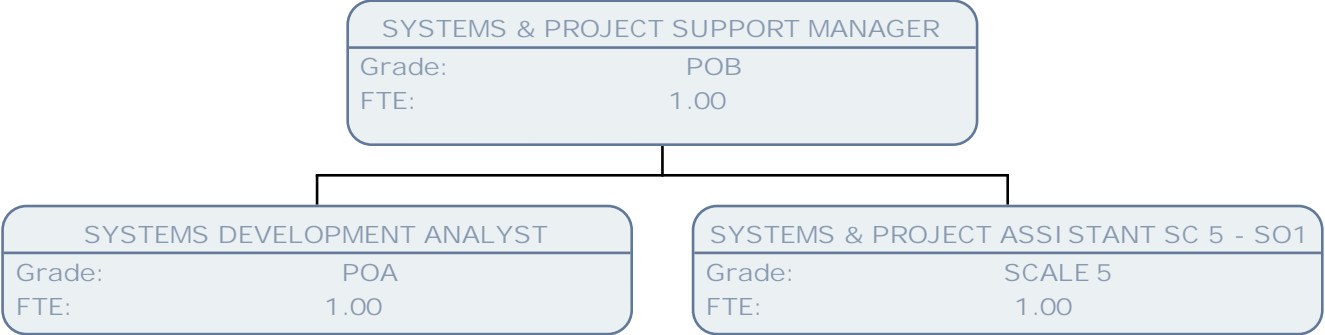

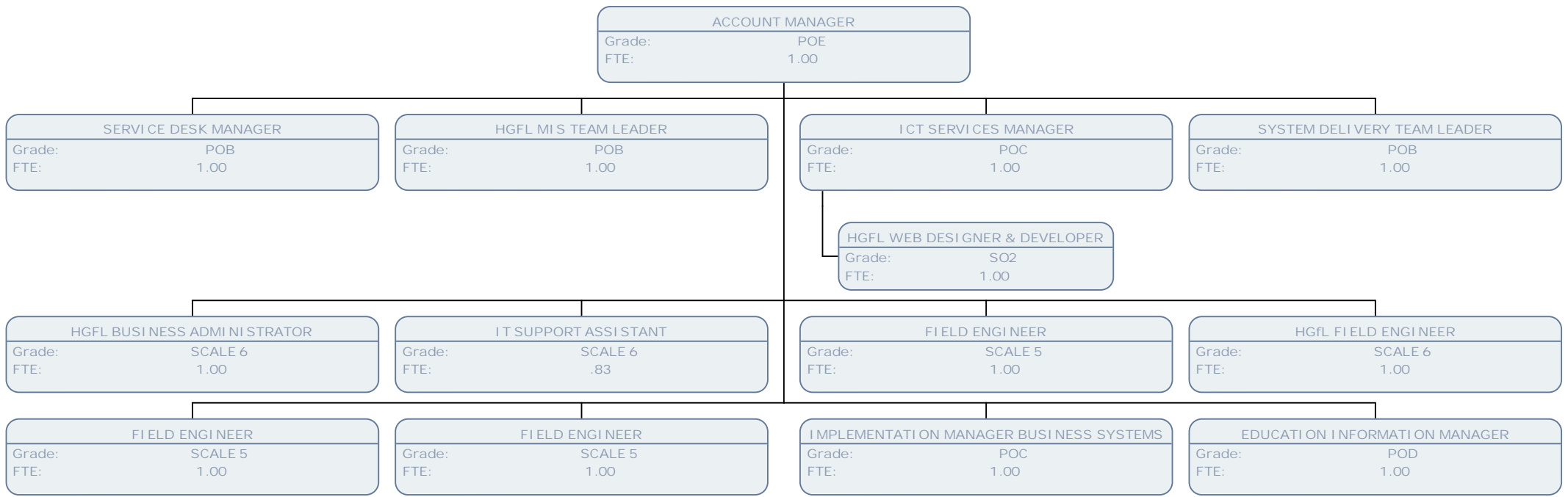

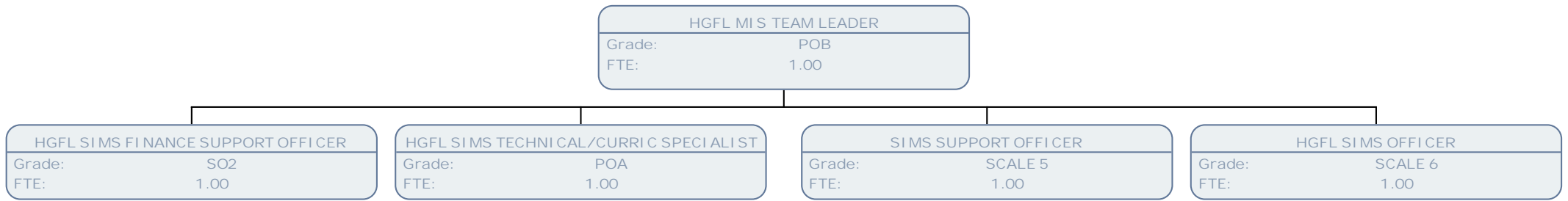

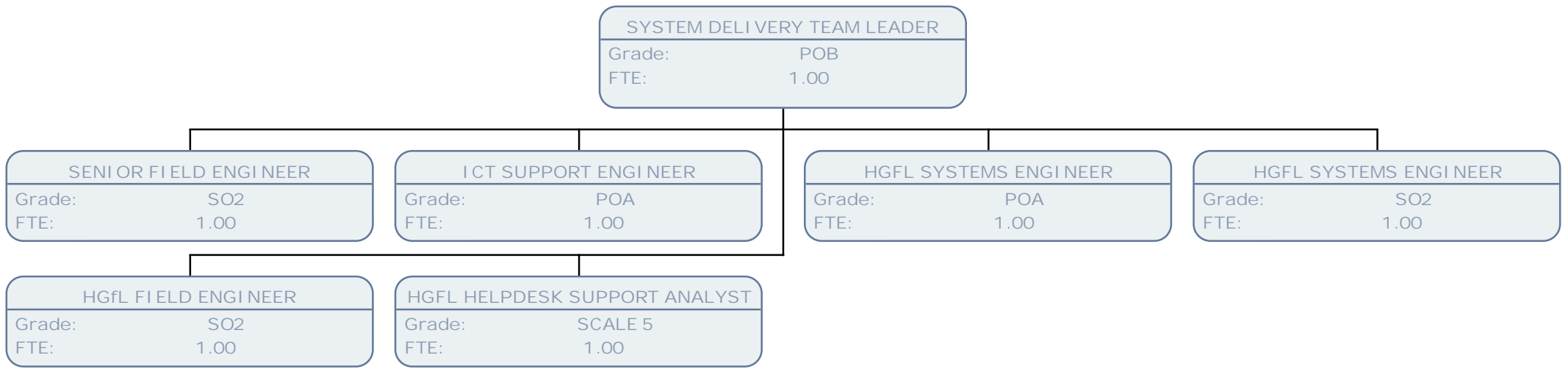

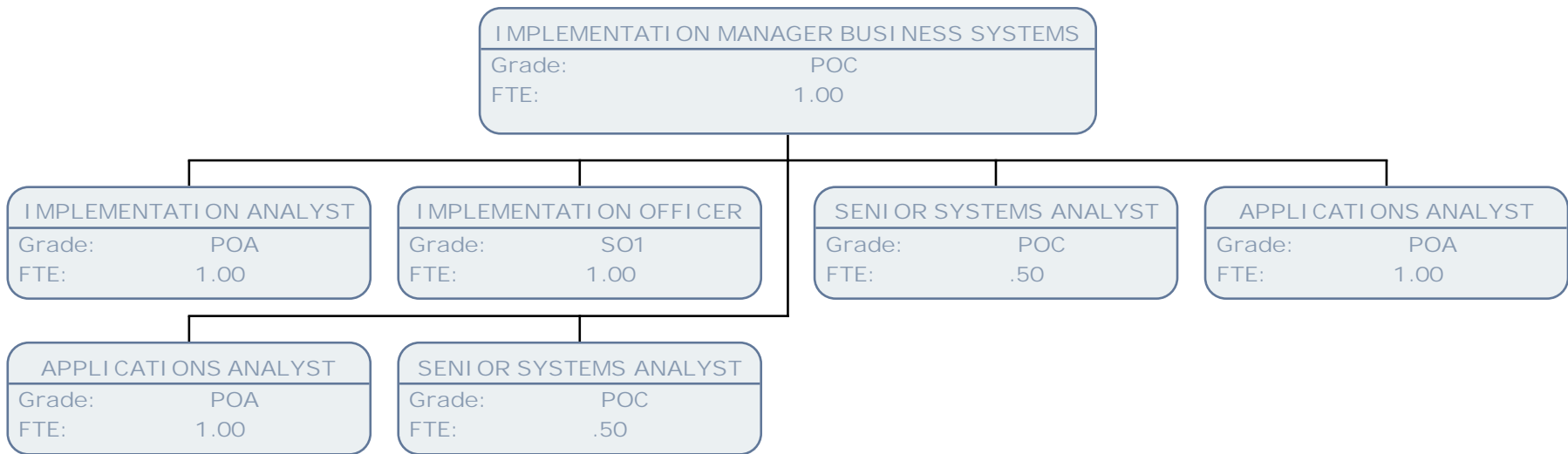

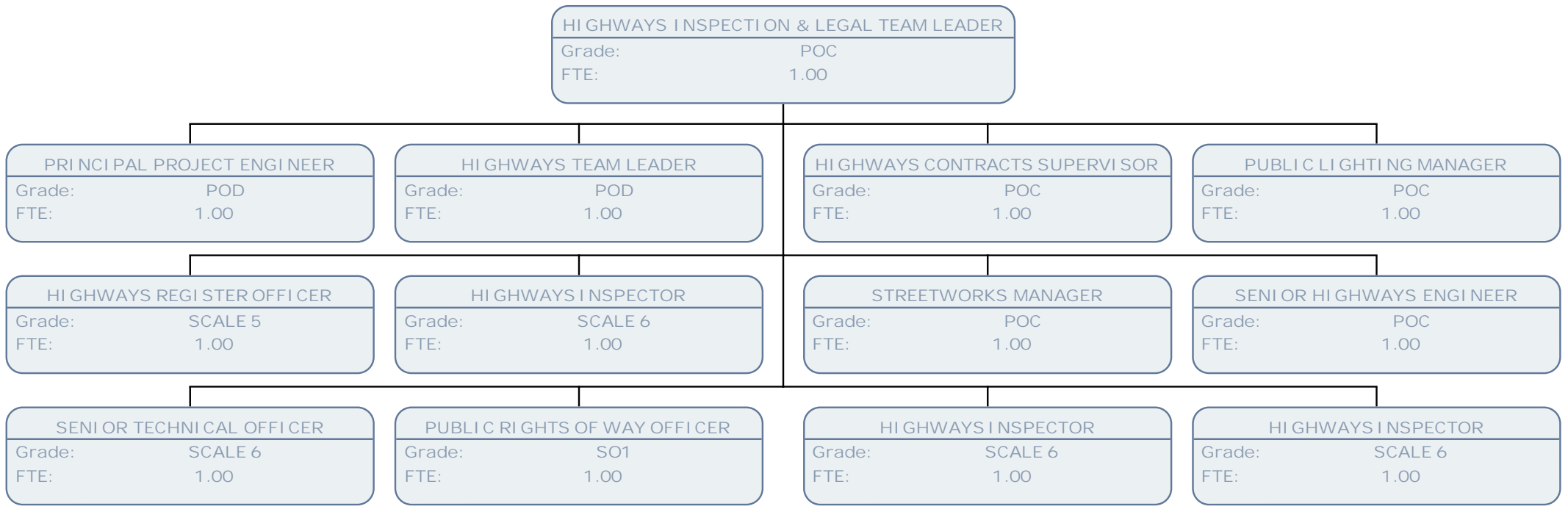

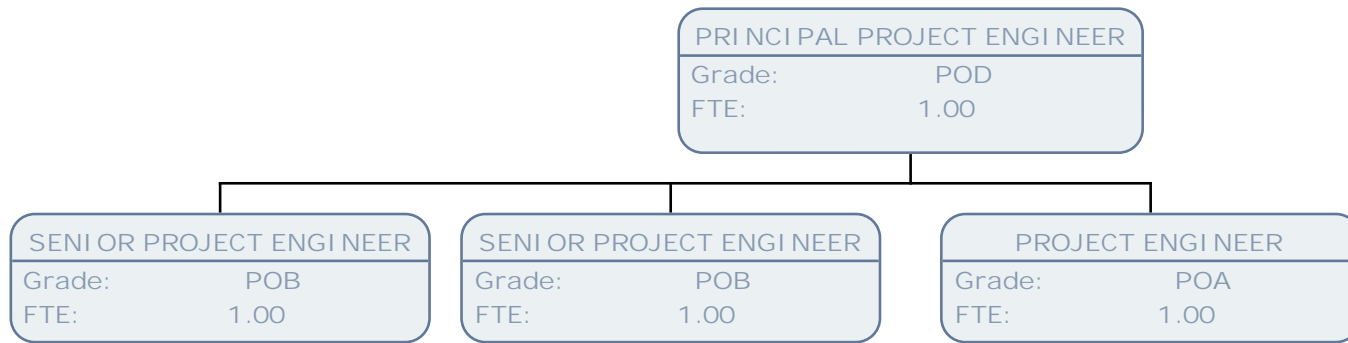

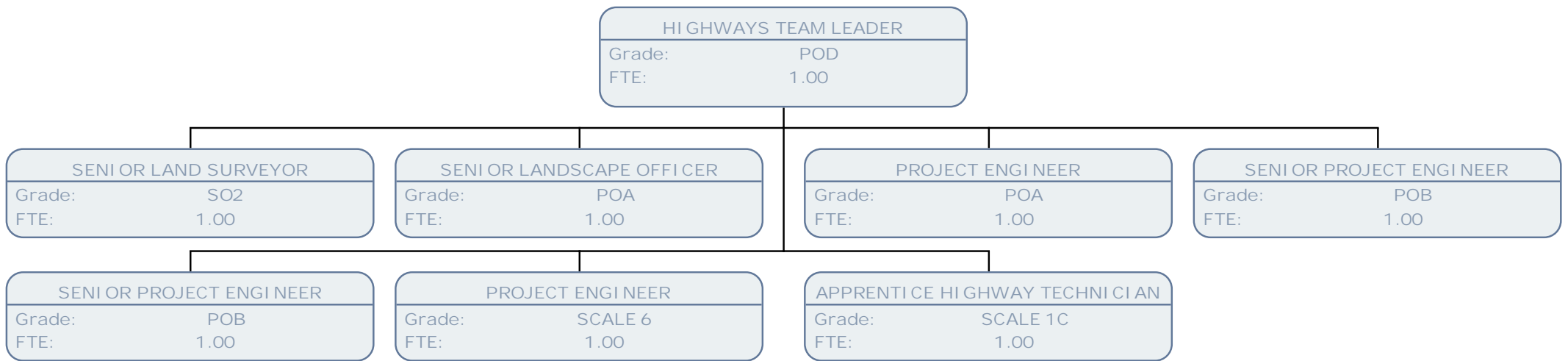

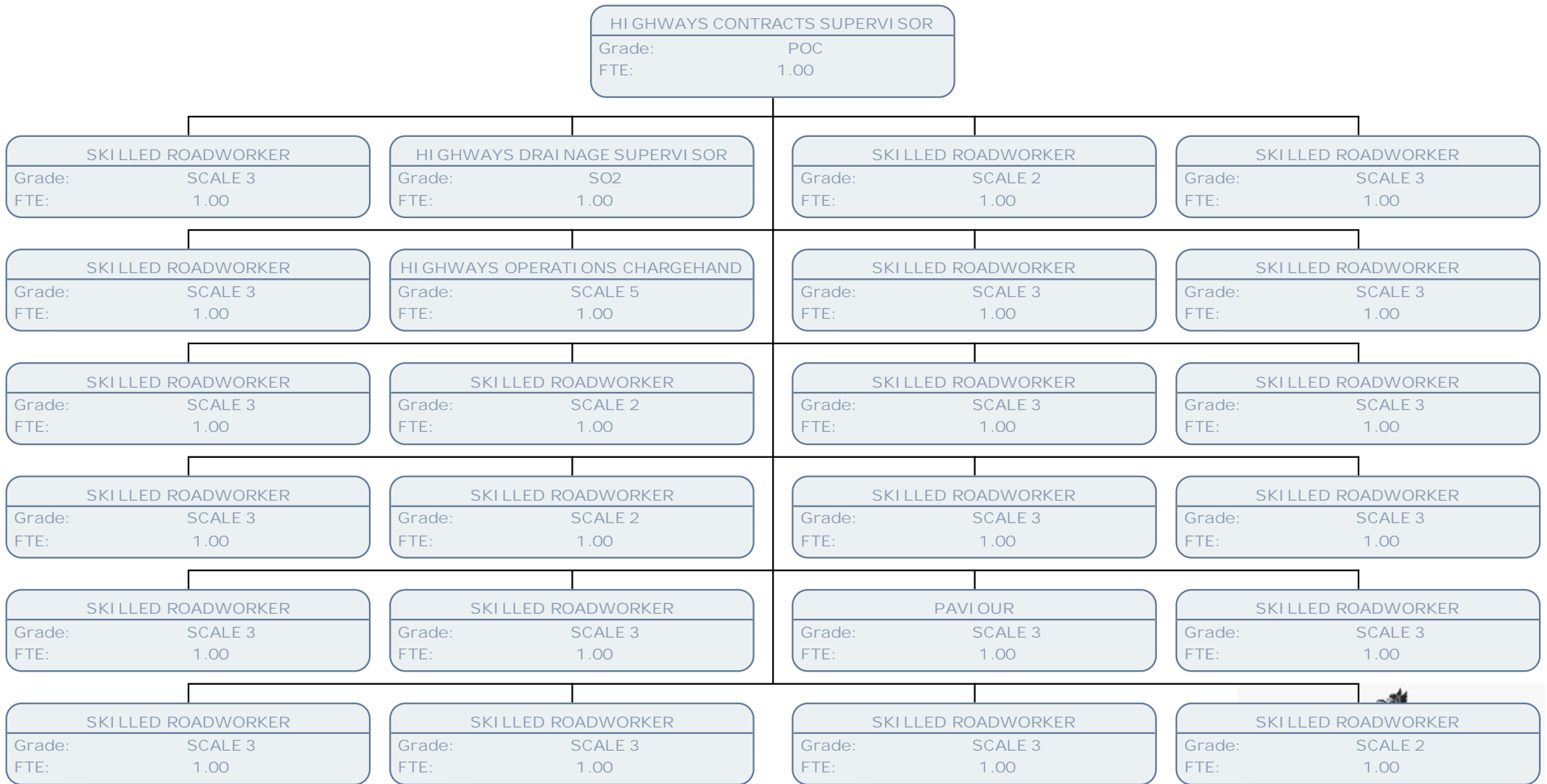

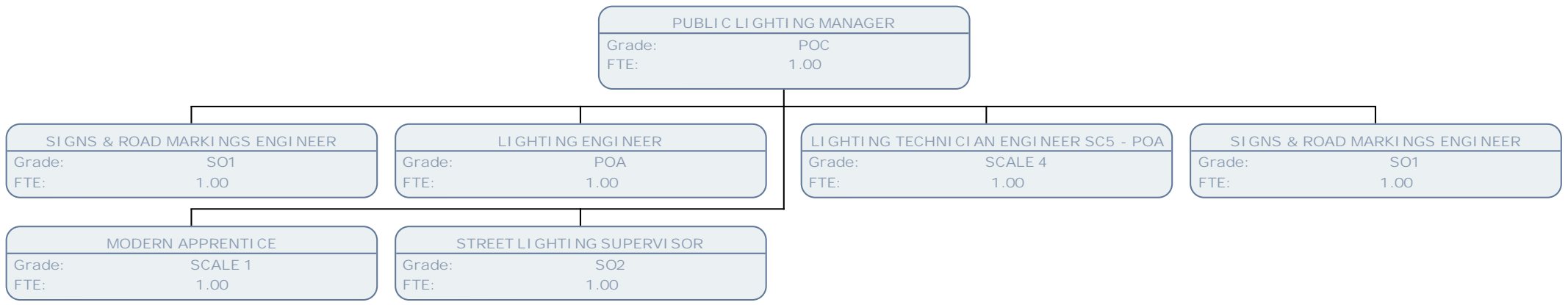

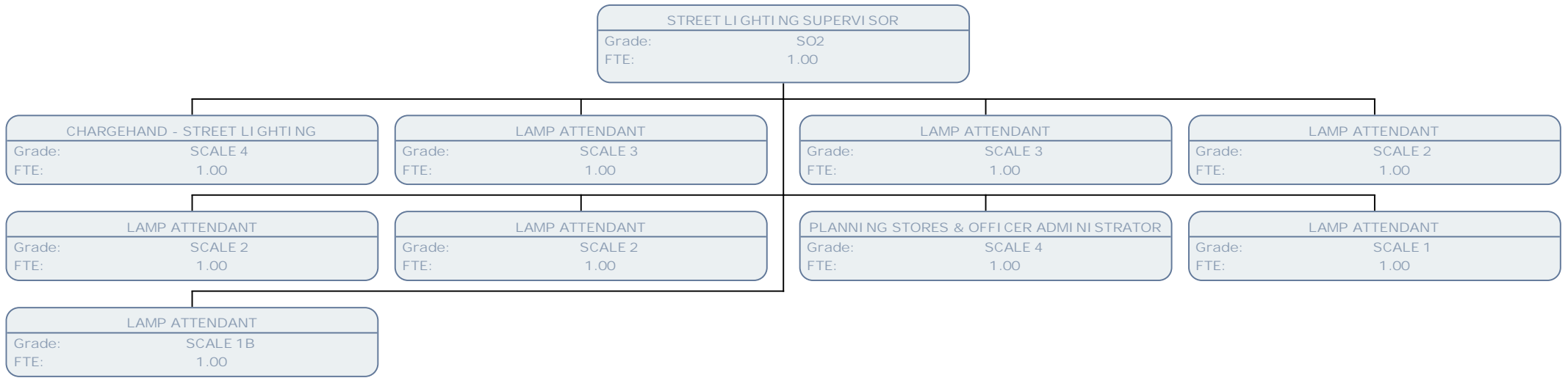

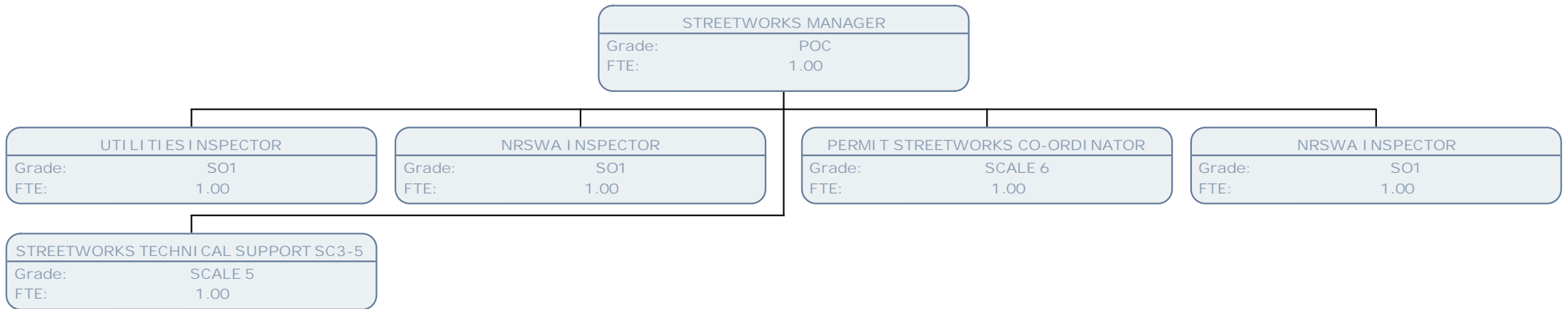

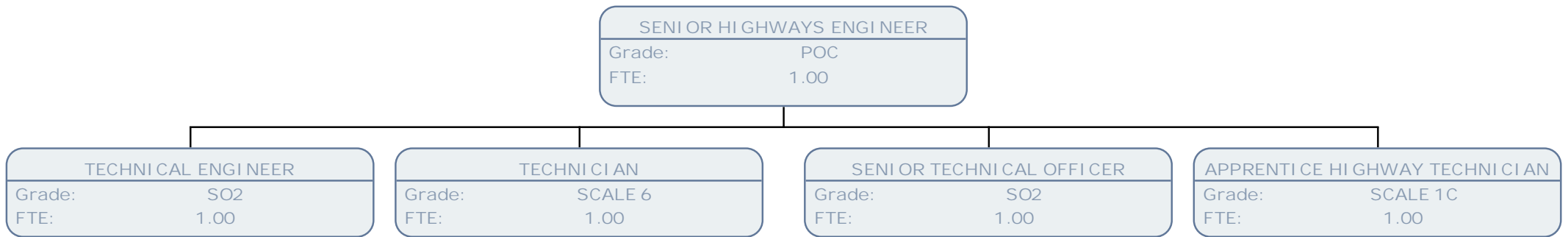

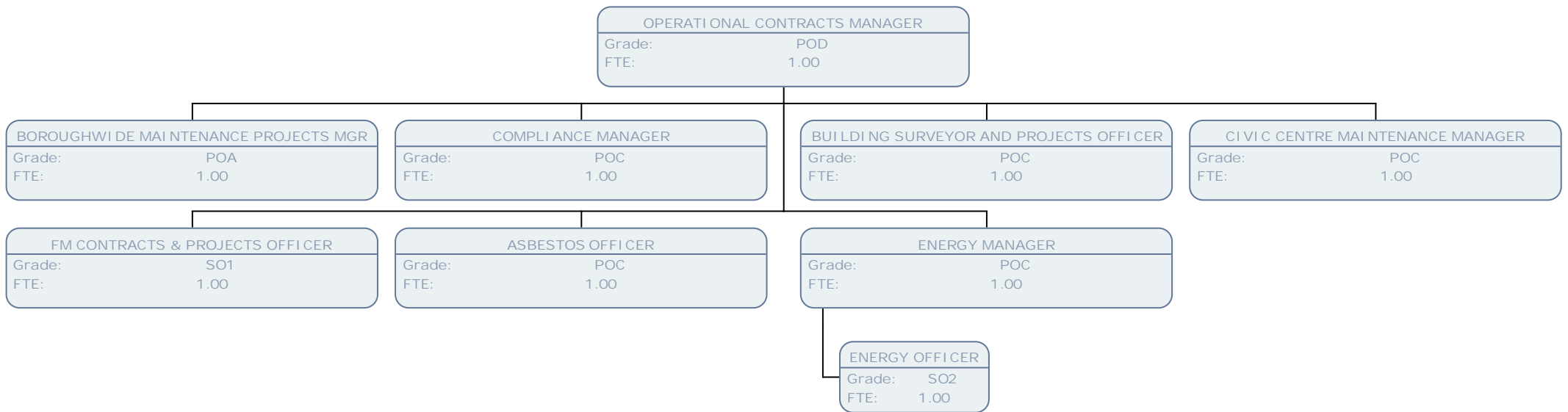

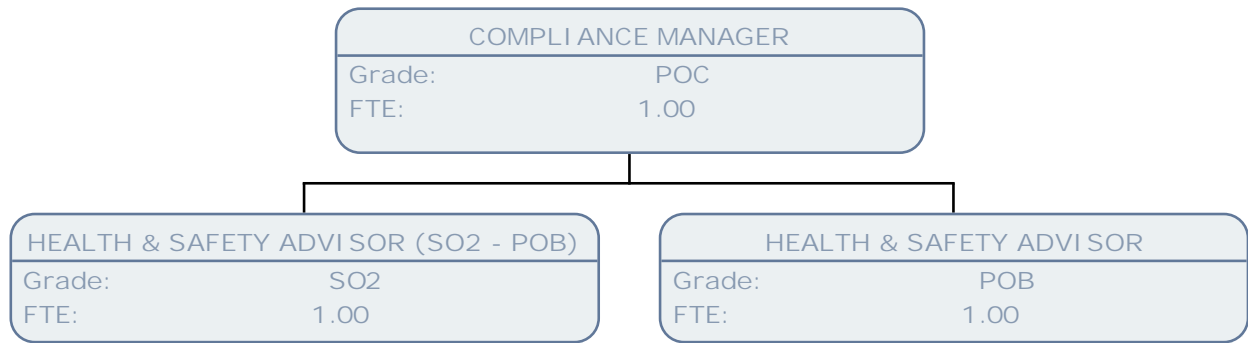

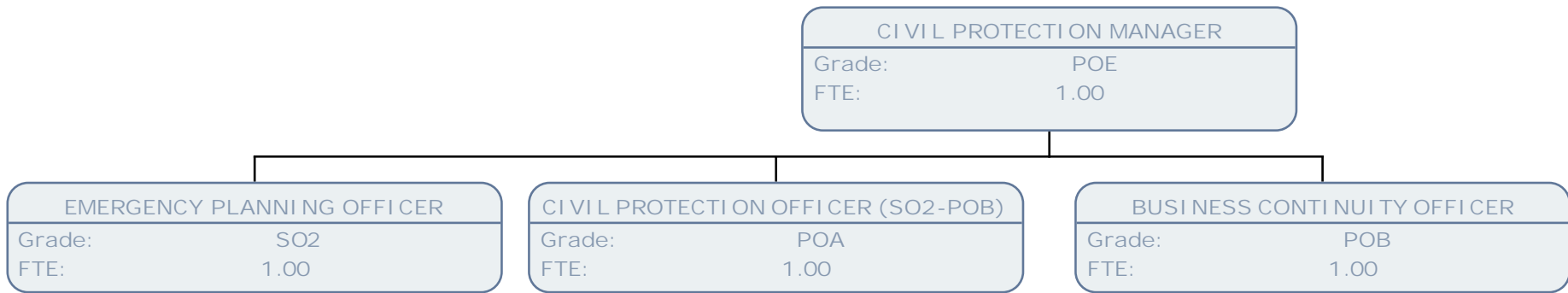

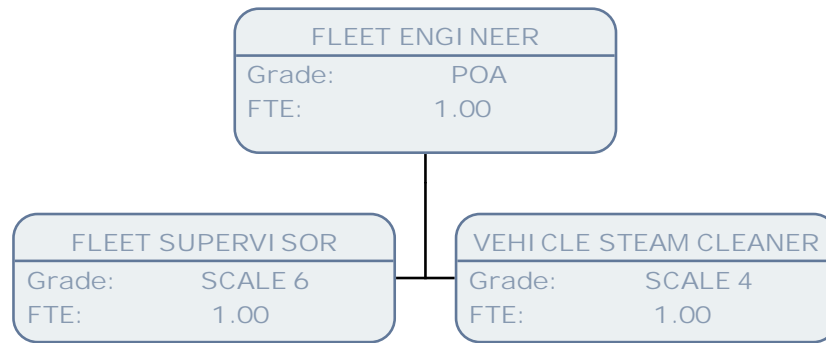

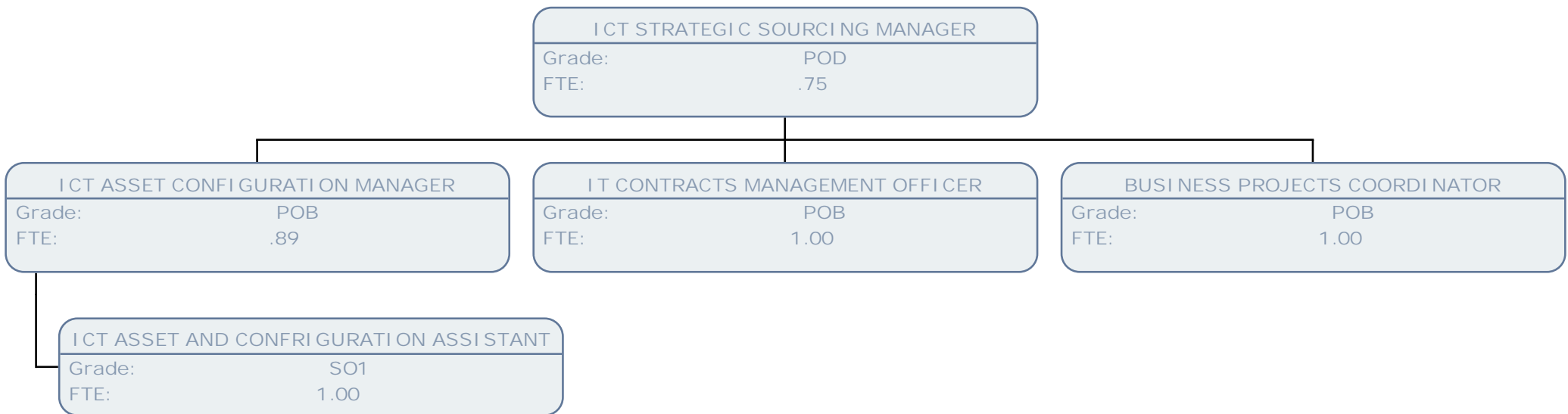

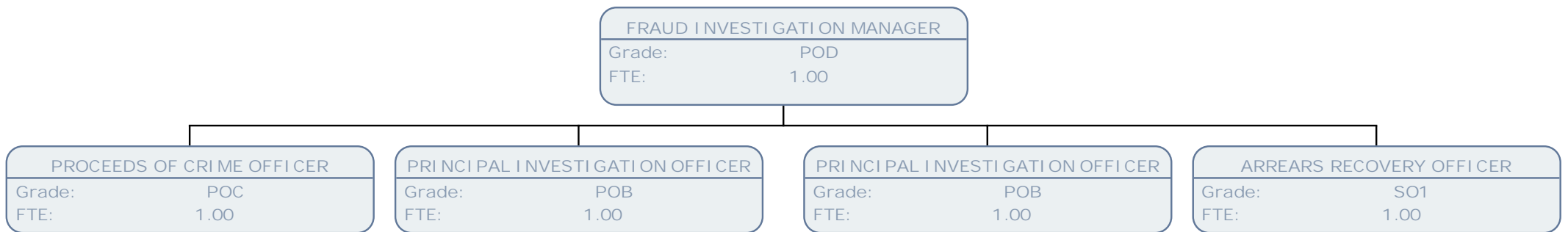

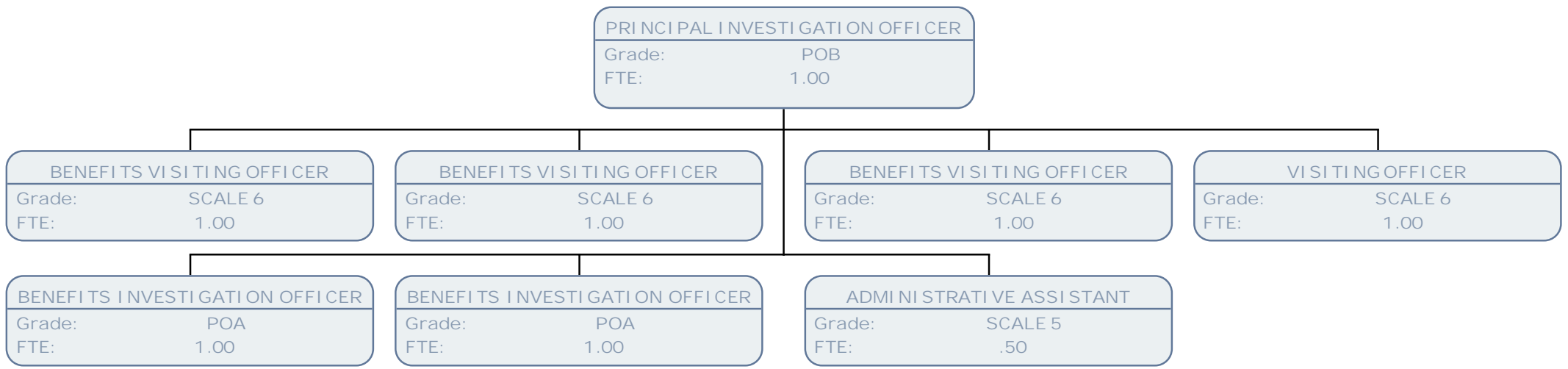

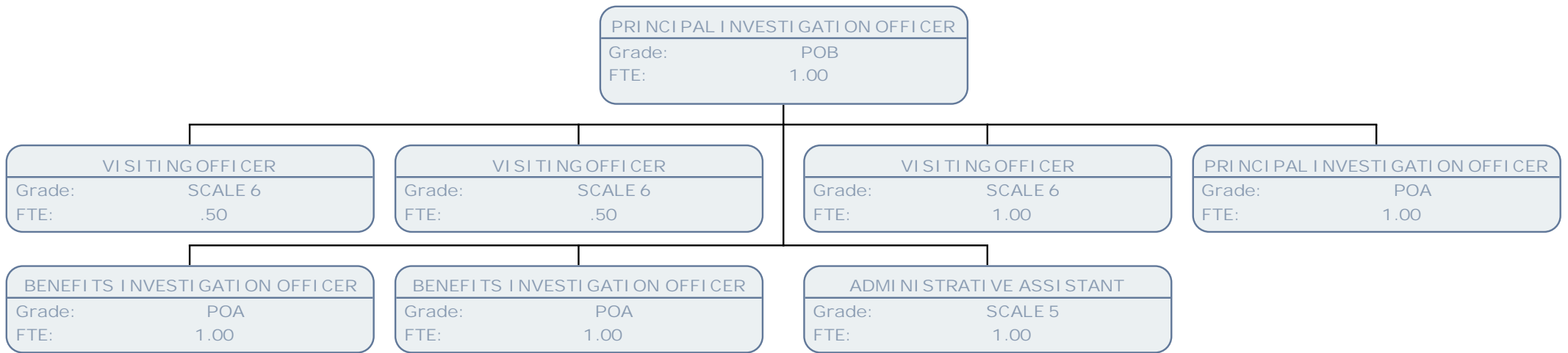

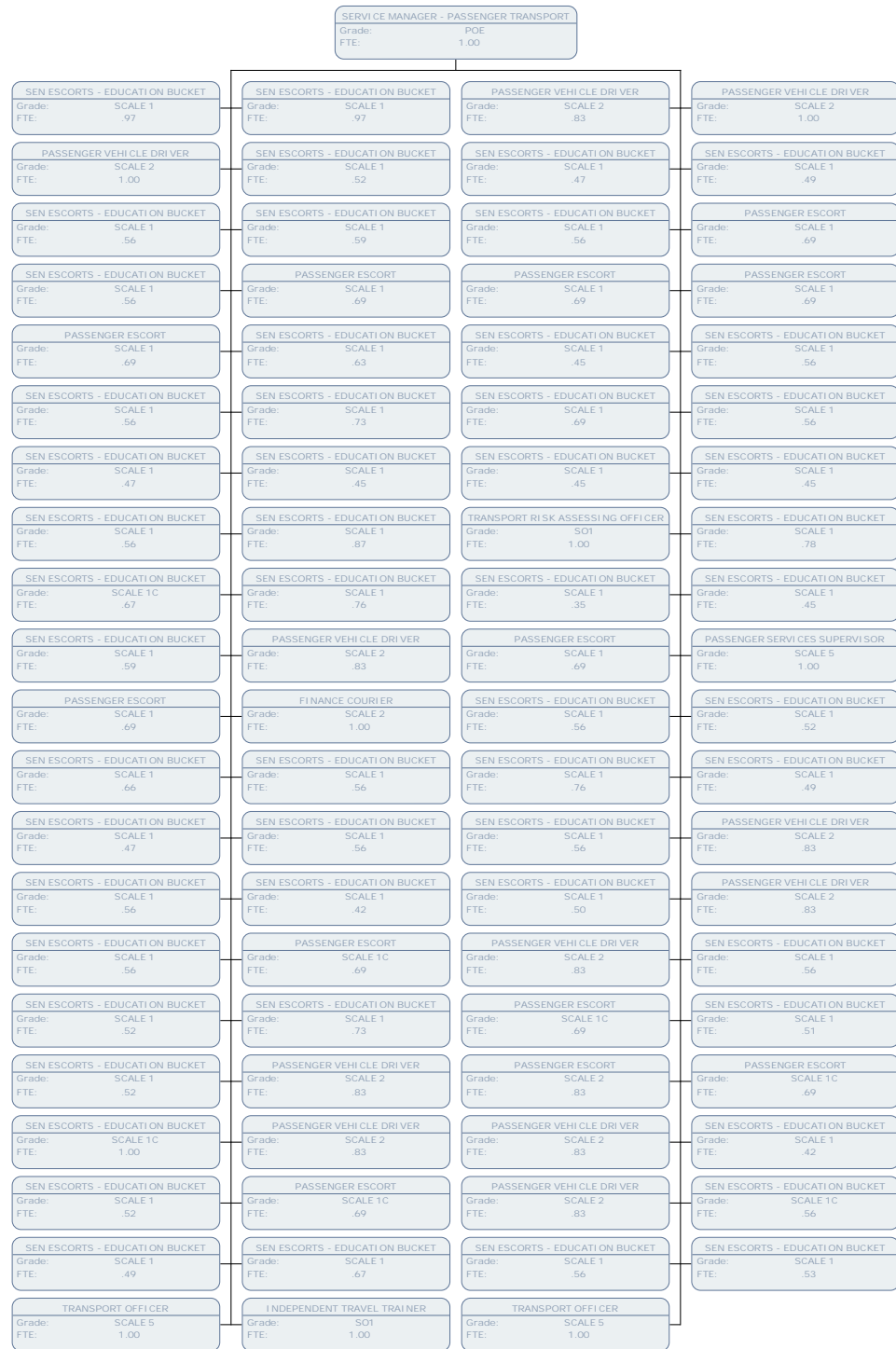

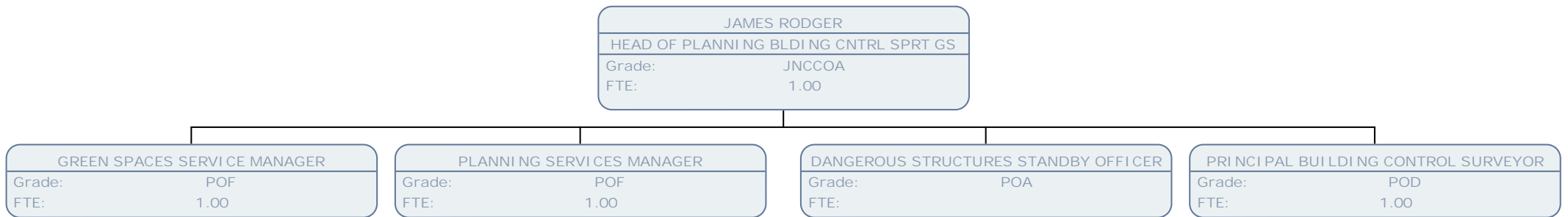

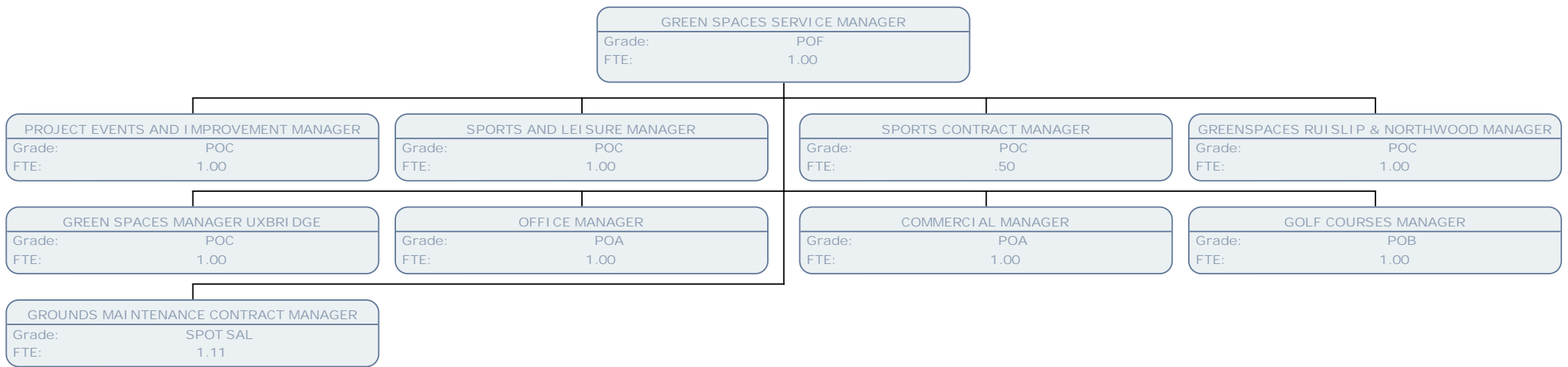

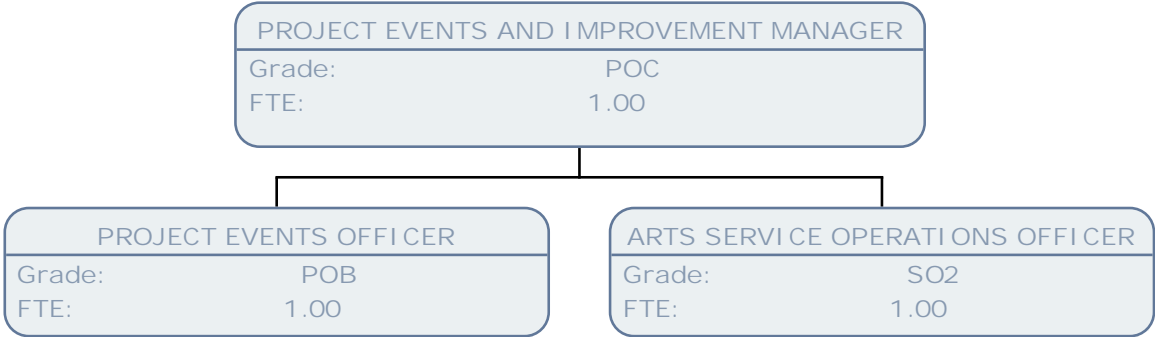

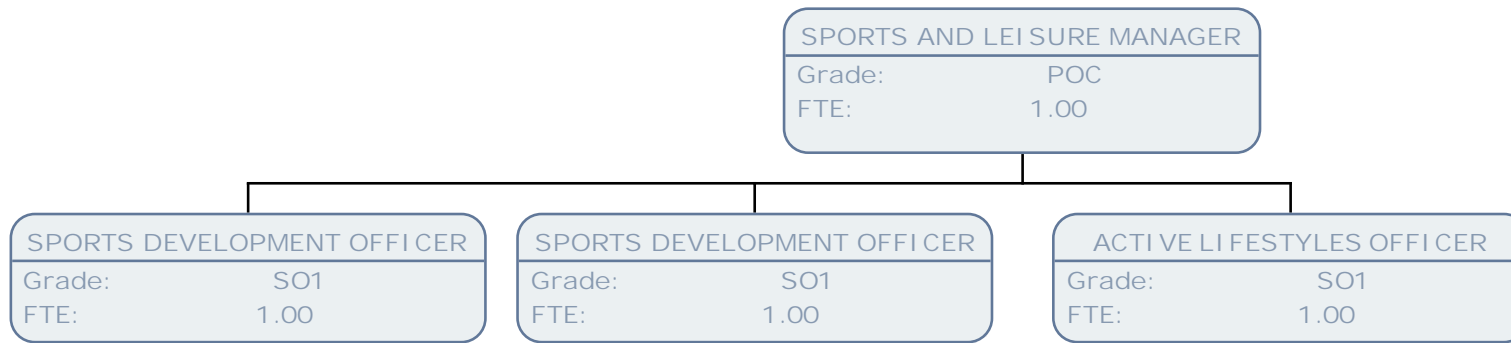

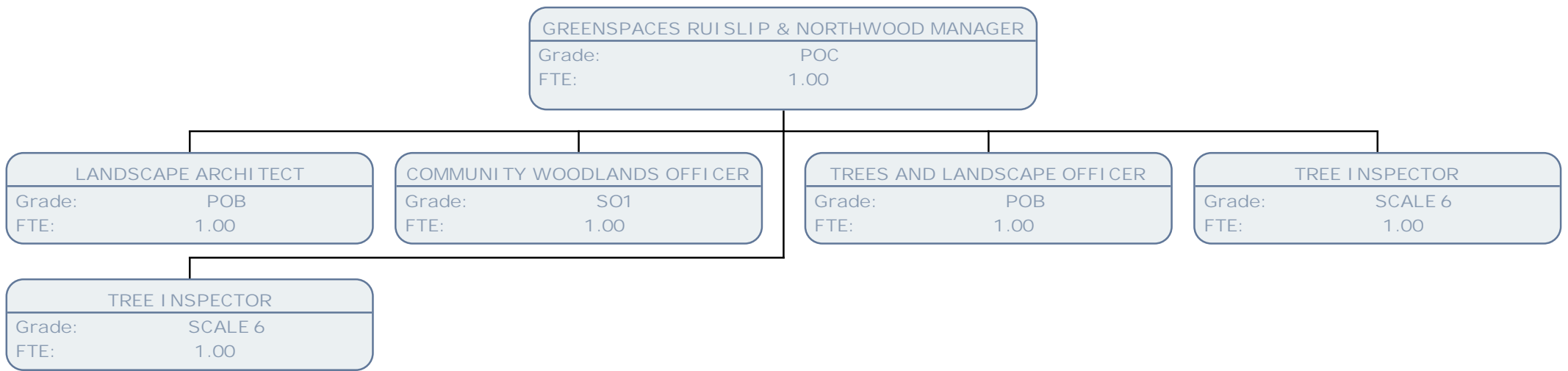

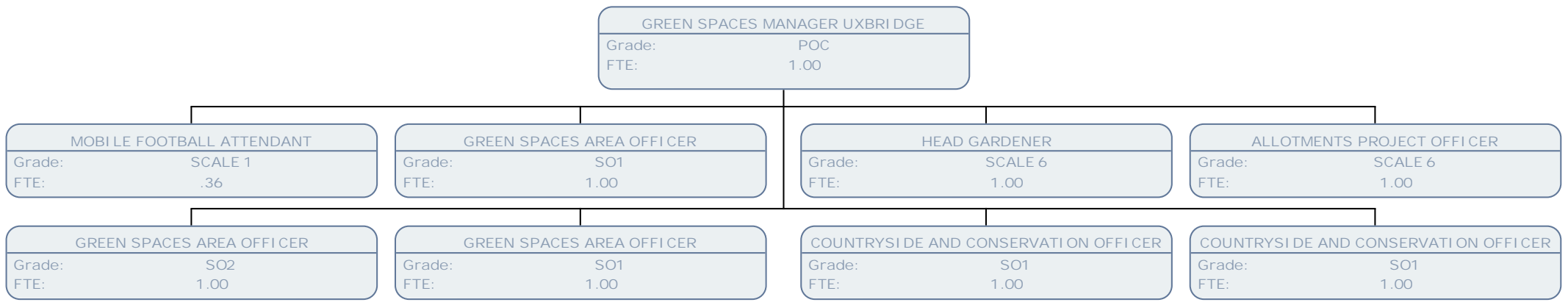

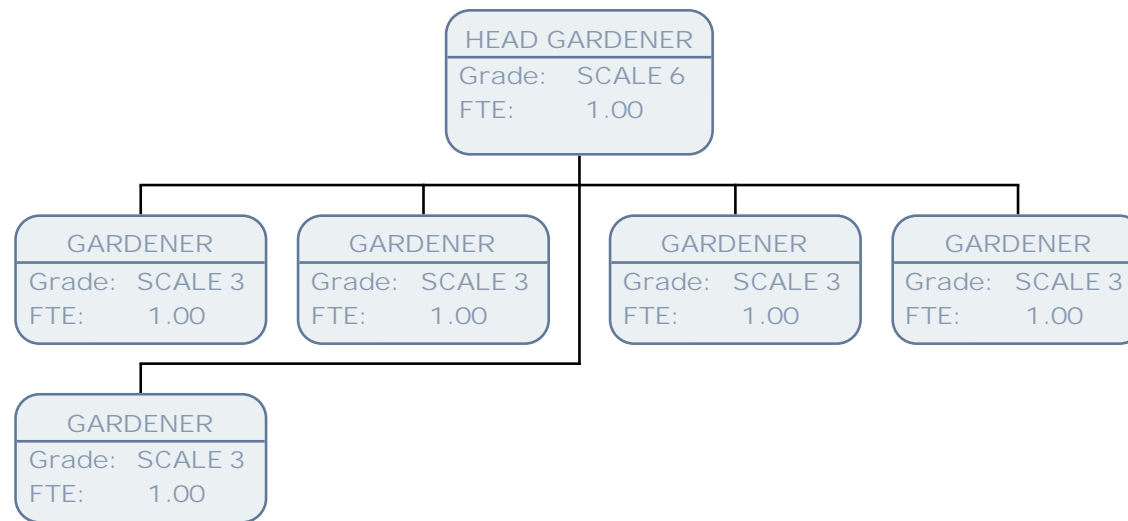

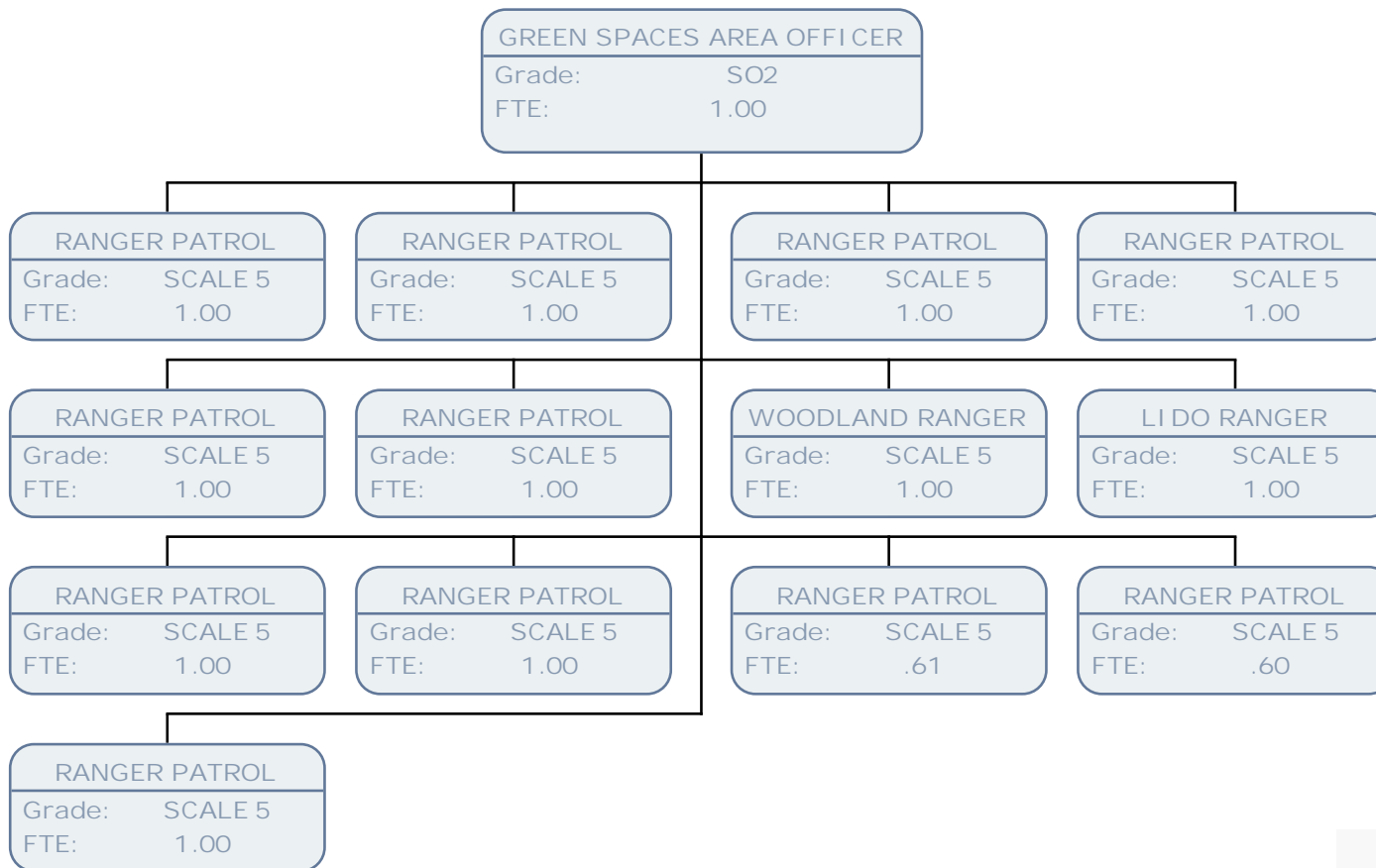

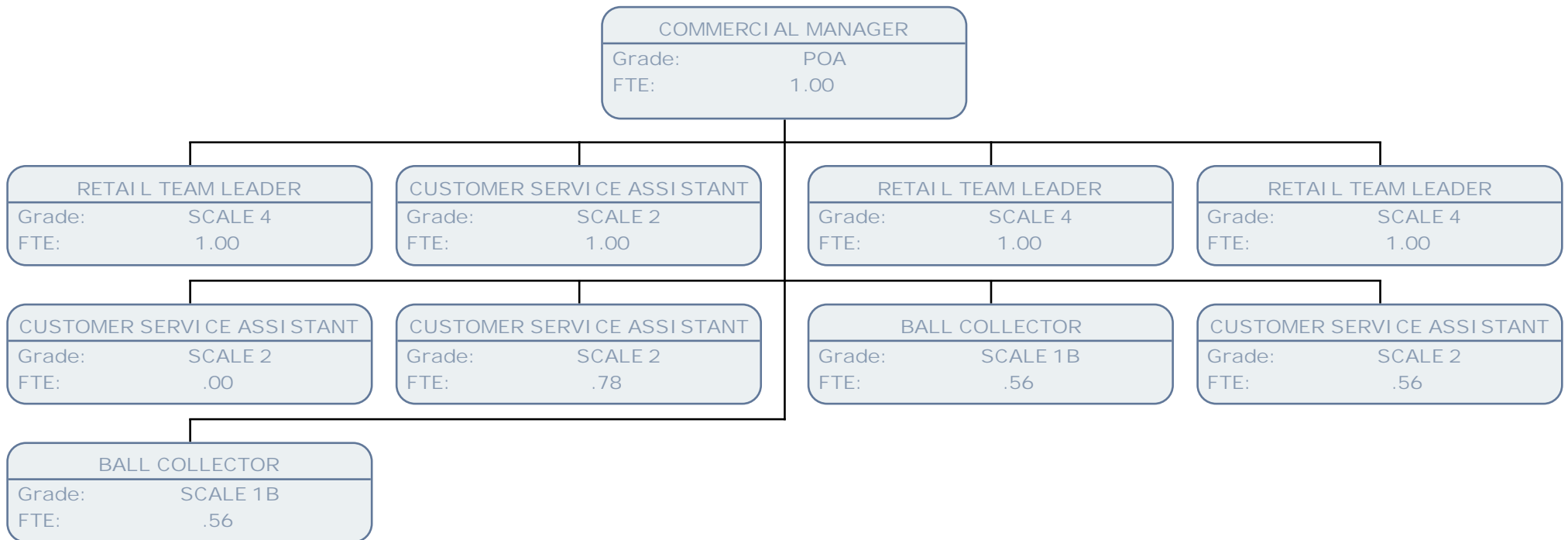

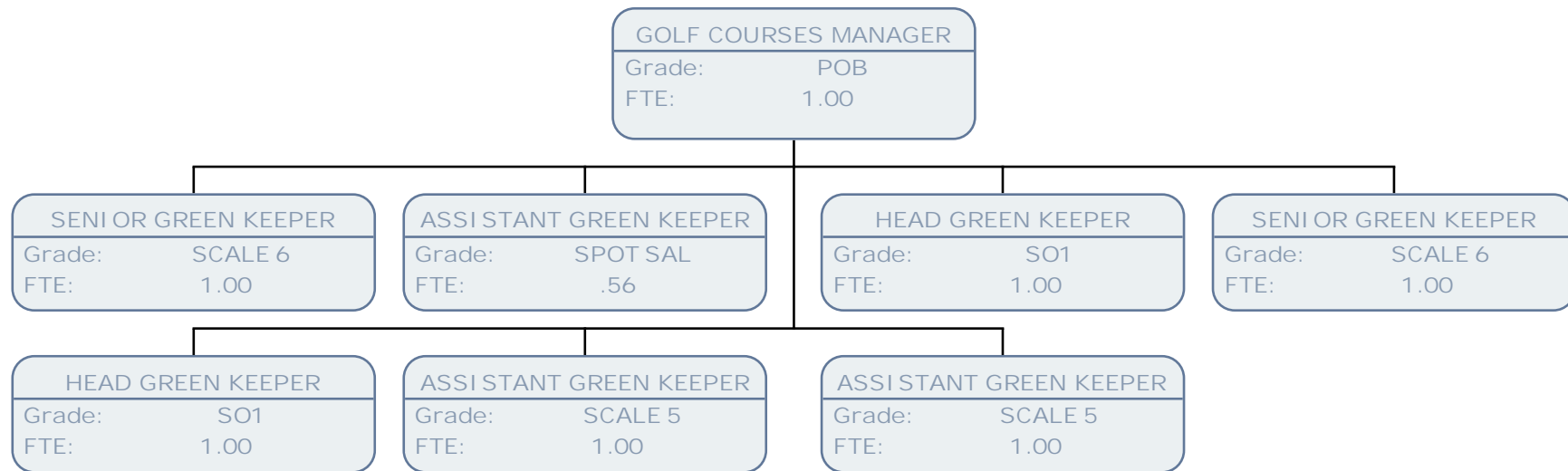

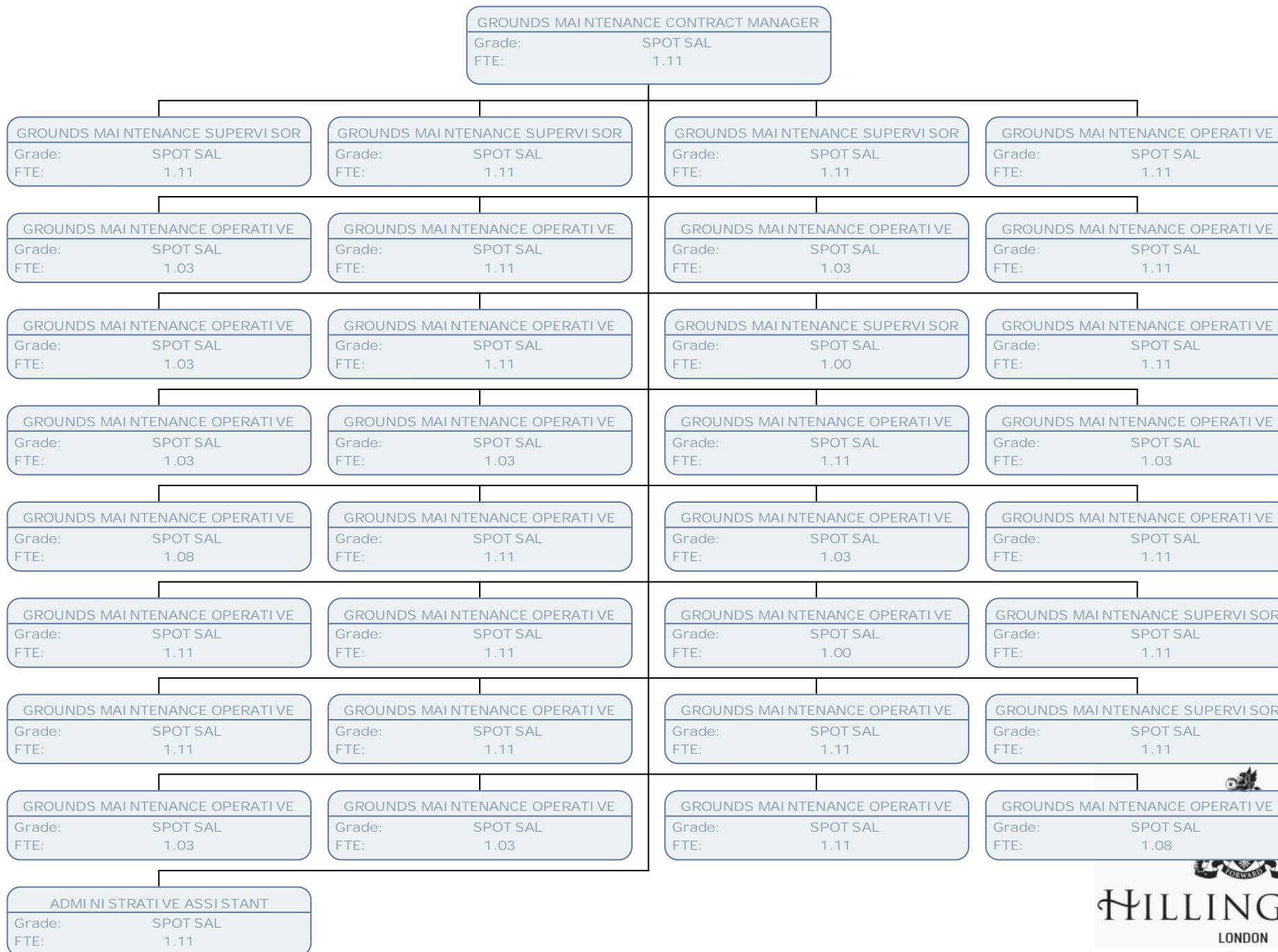

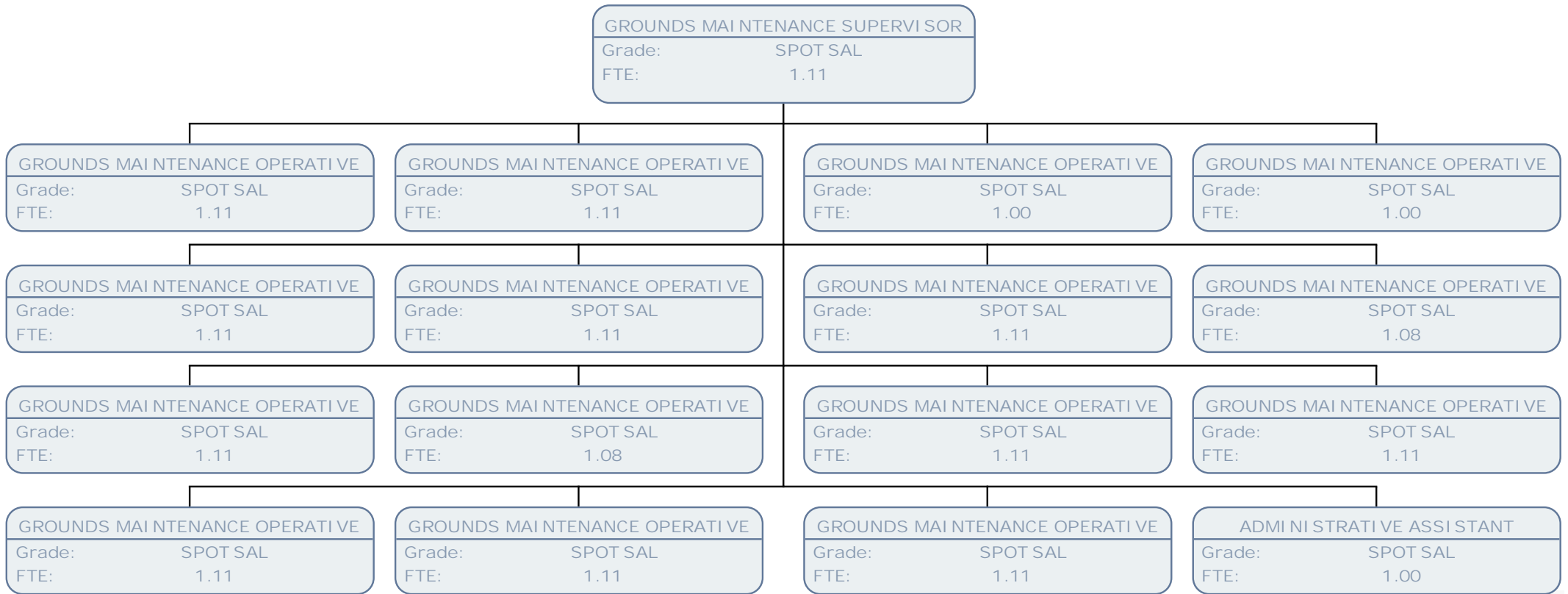

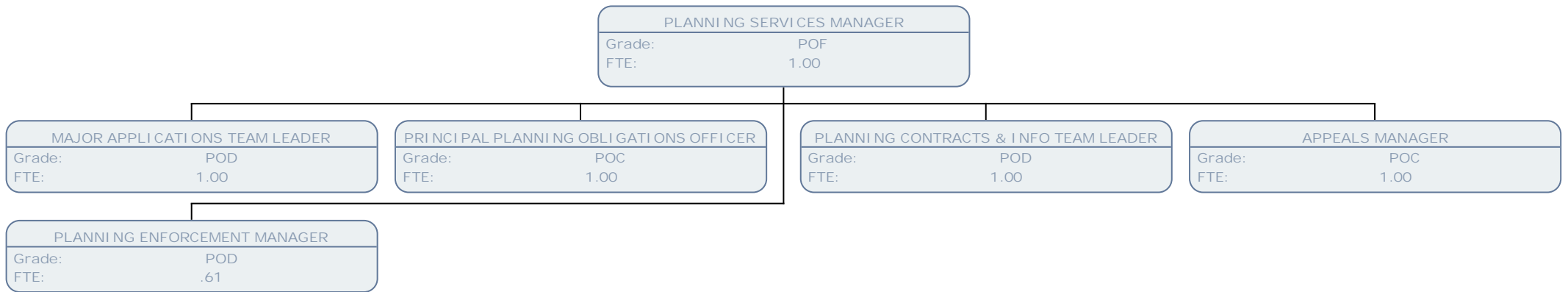

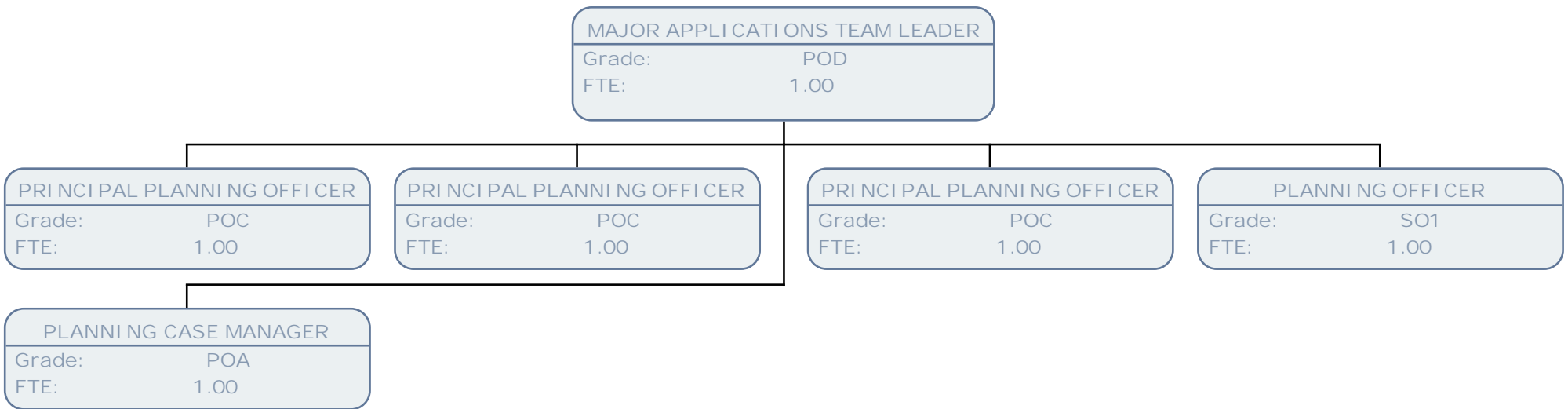

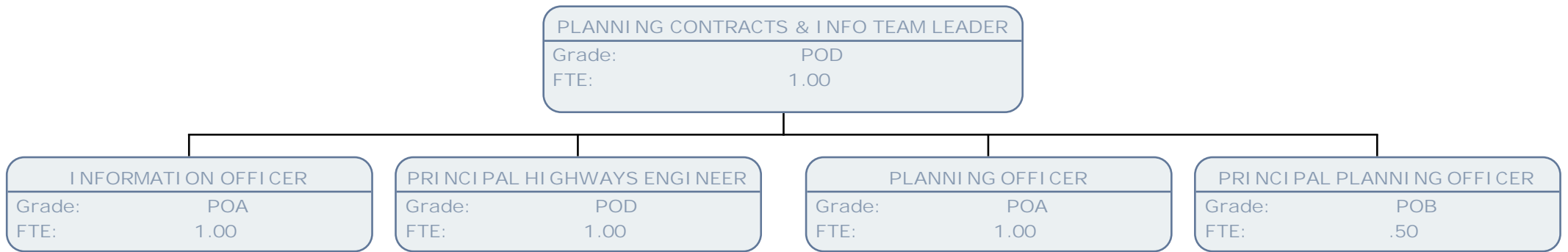

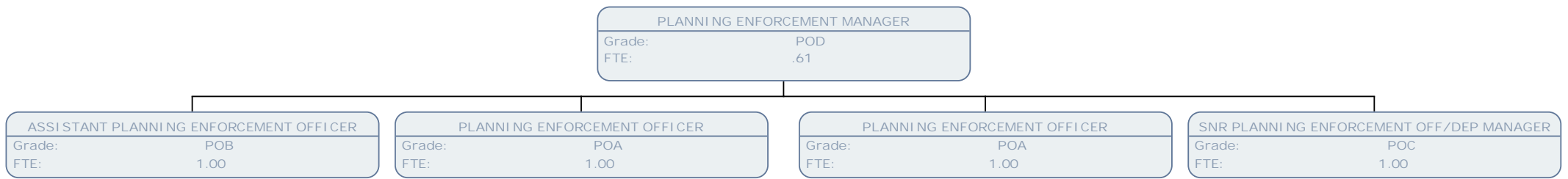

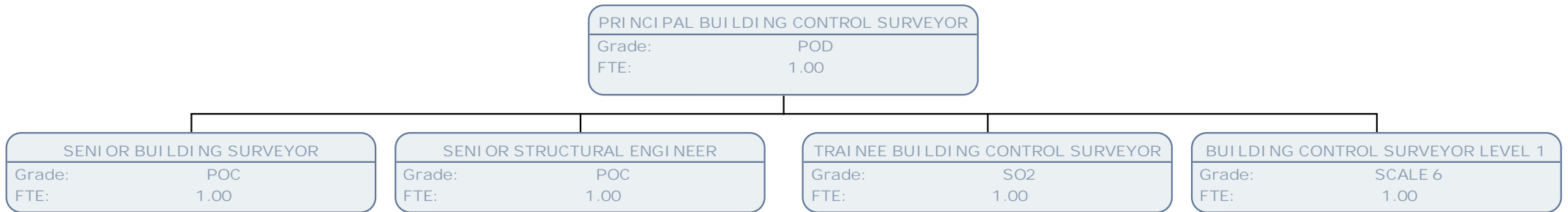

AILEEN CARLISLE	
INTERIM CORPORATE TRANSFORMATION MANAGER	
Grade:	SPOT SALARY
FTE:	

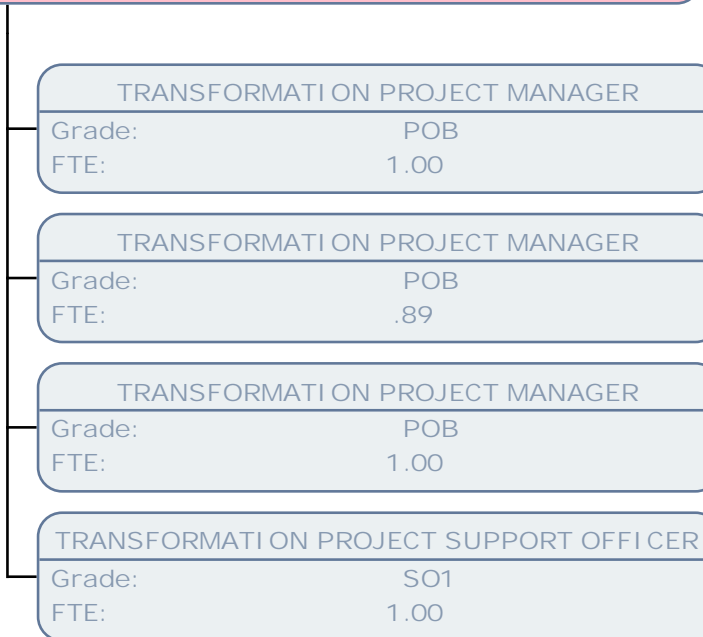

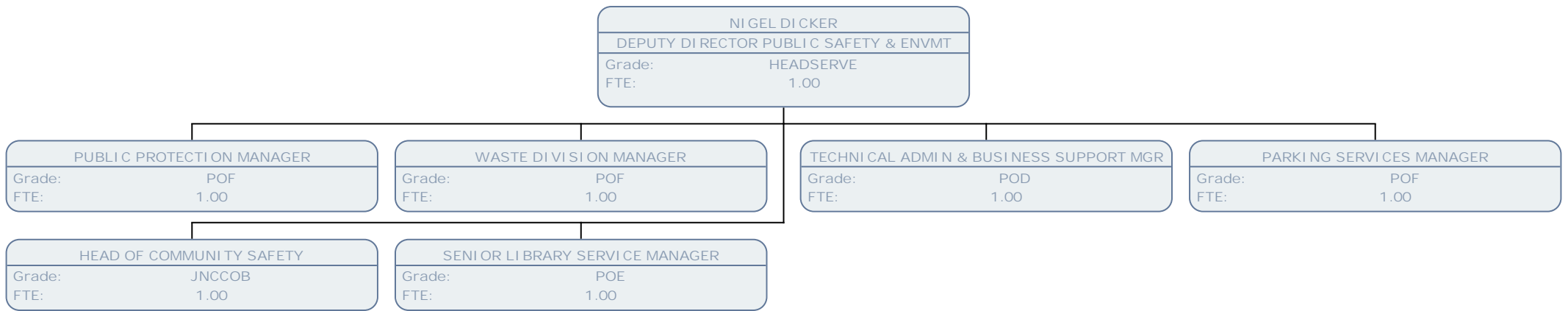

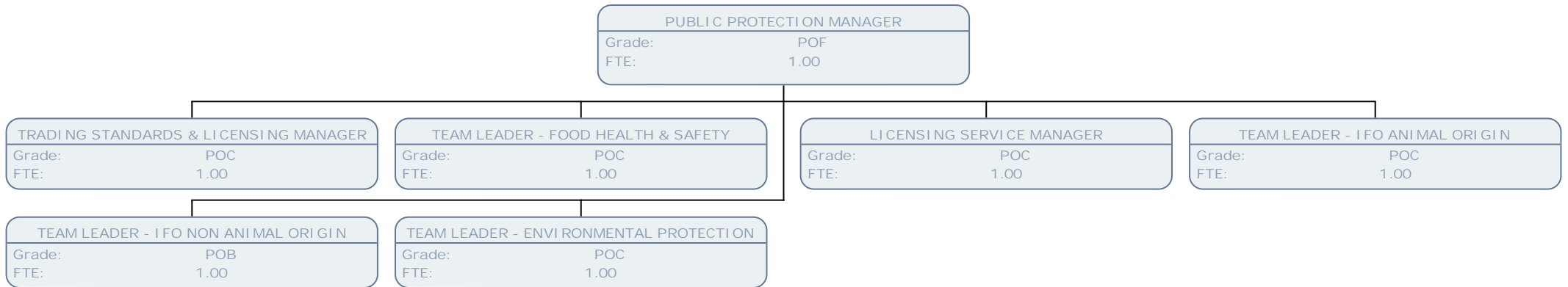

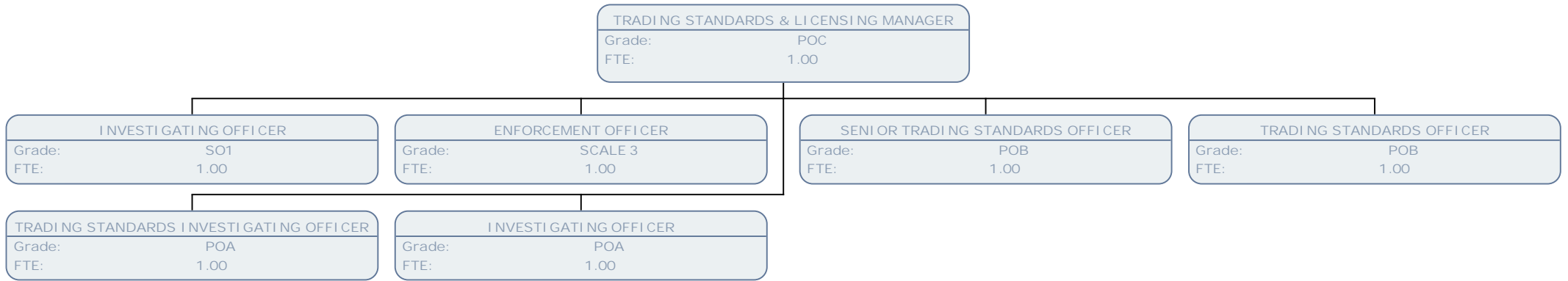

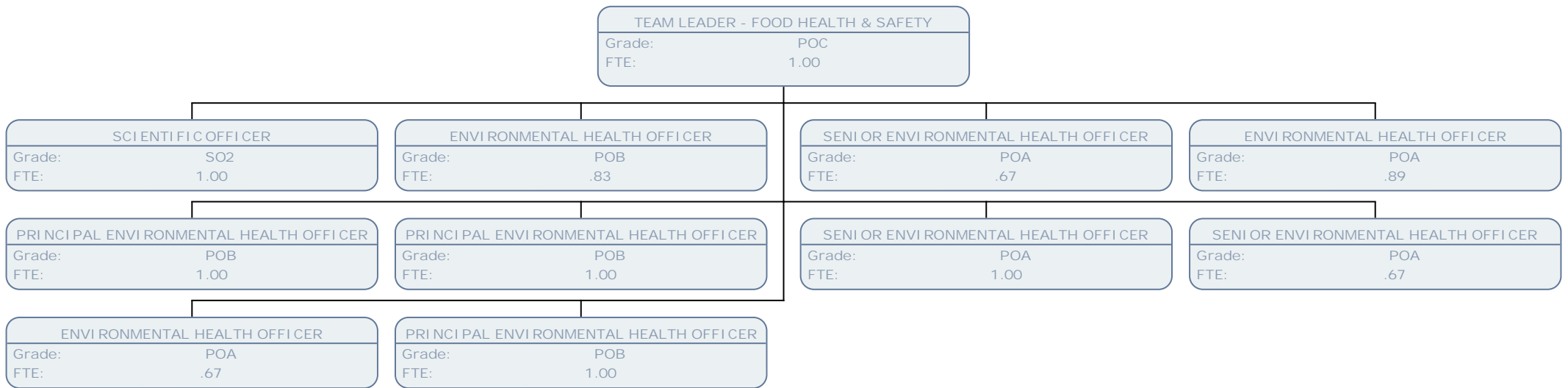

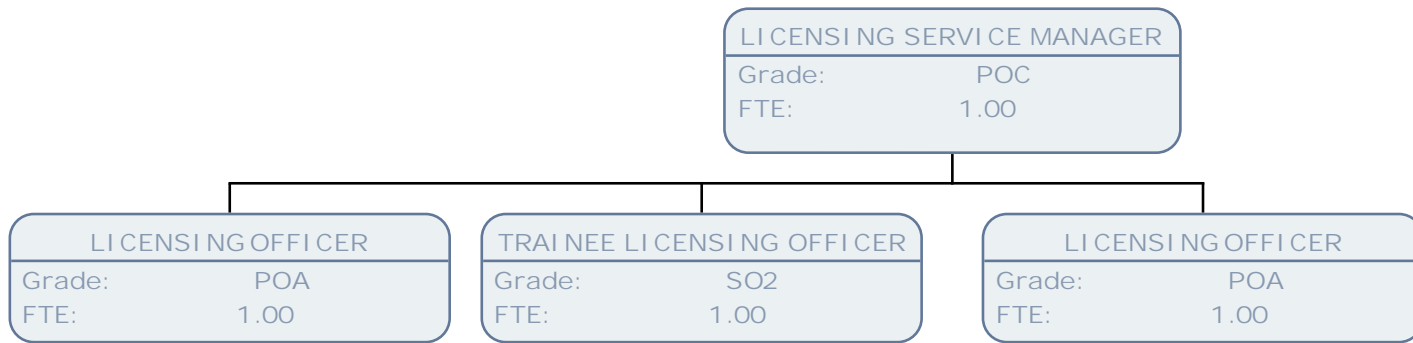

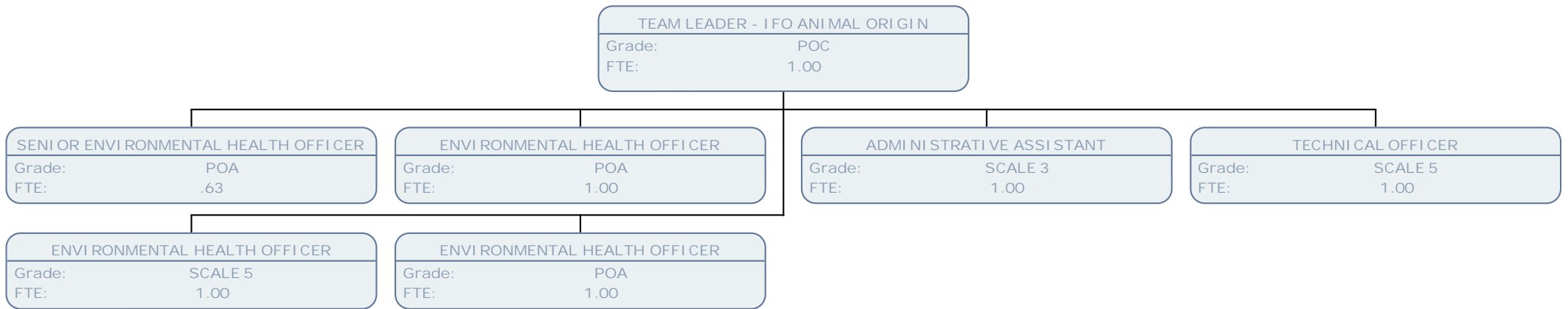

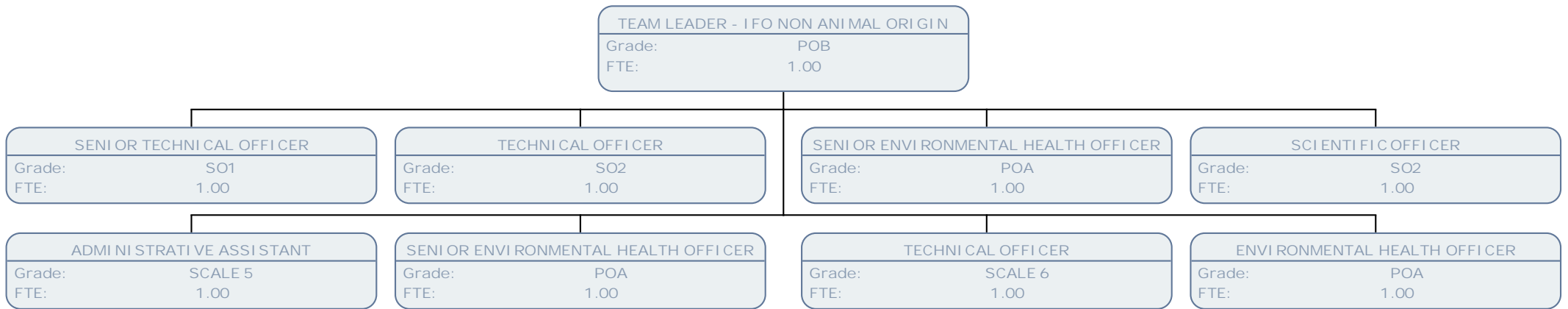

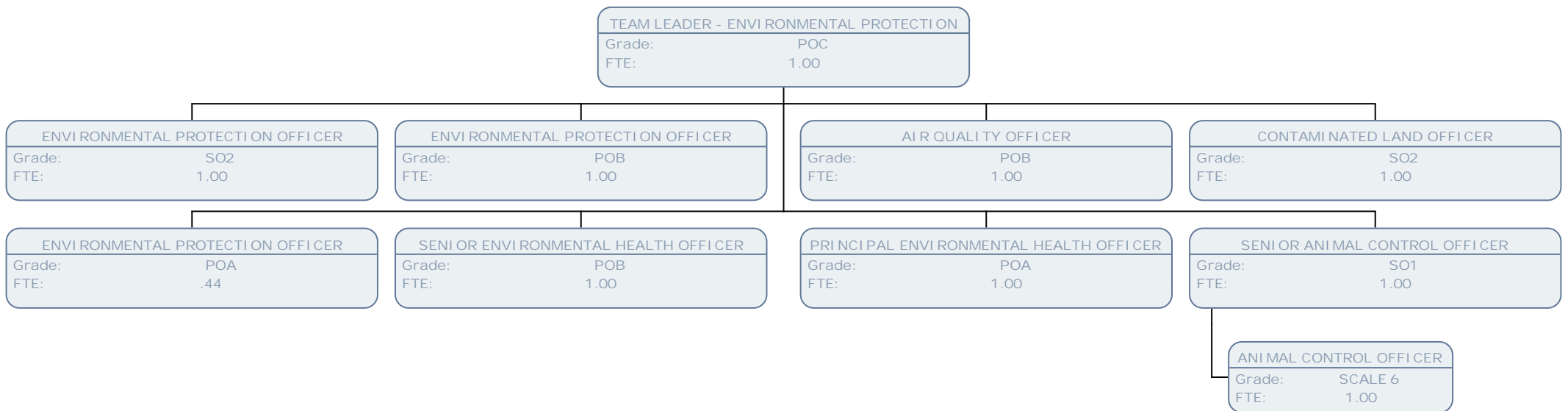

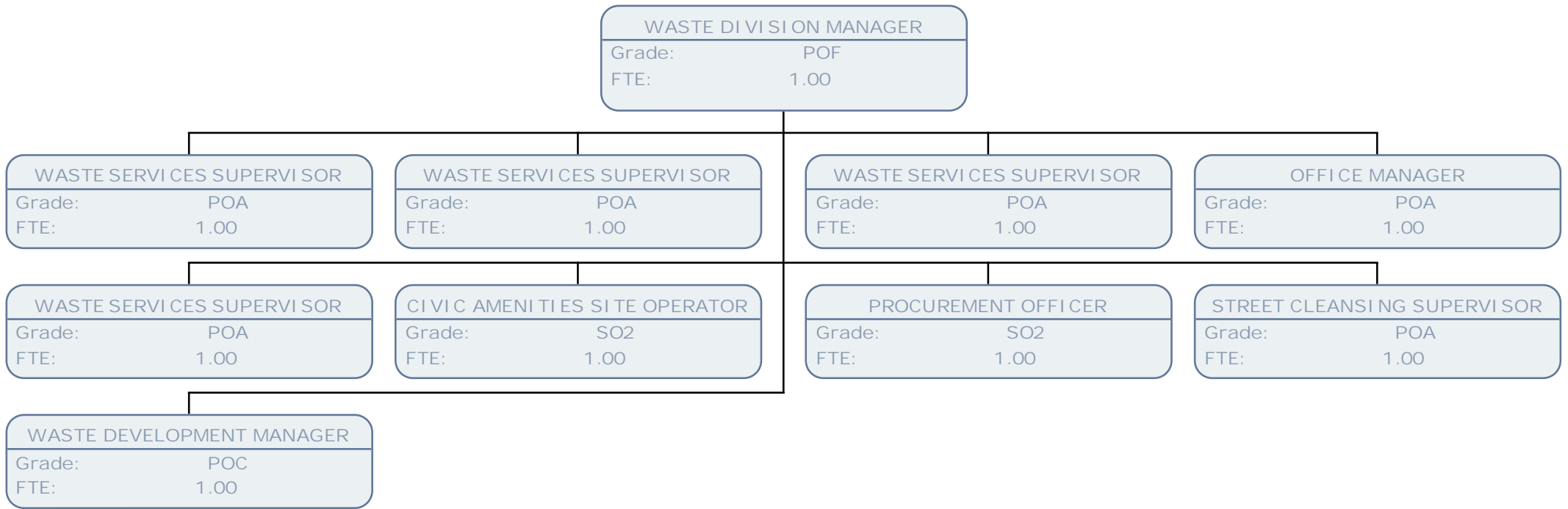

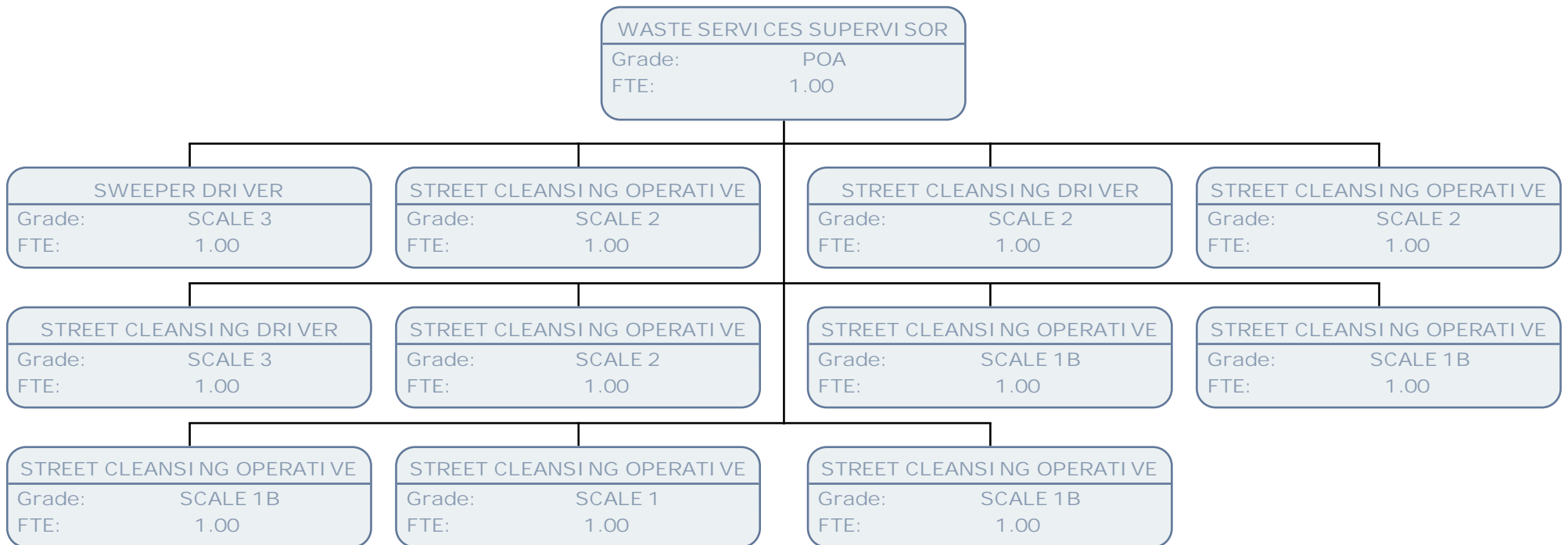

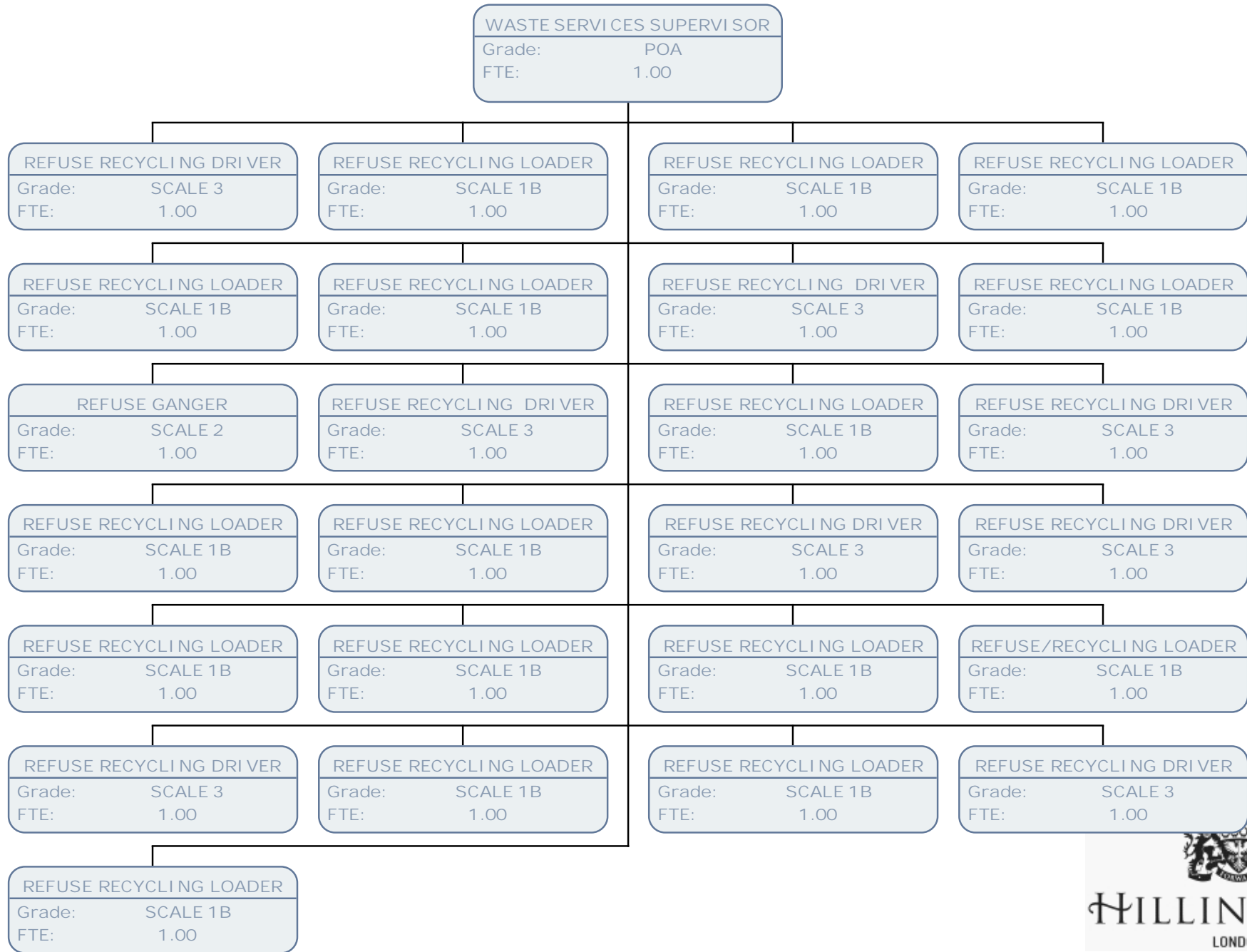

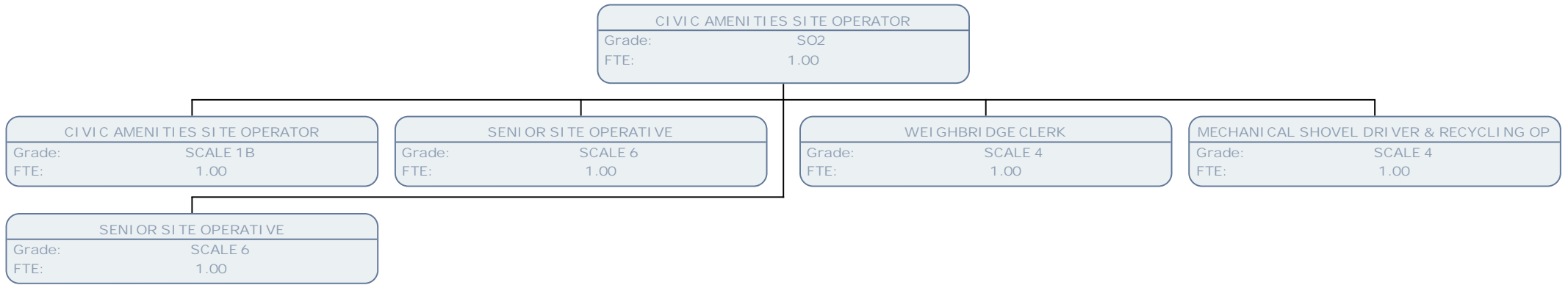

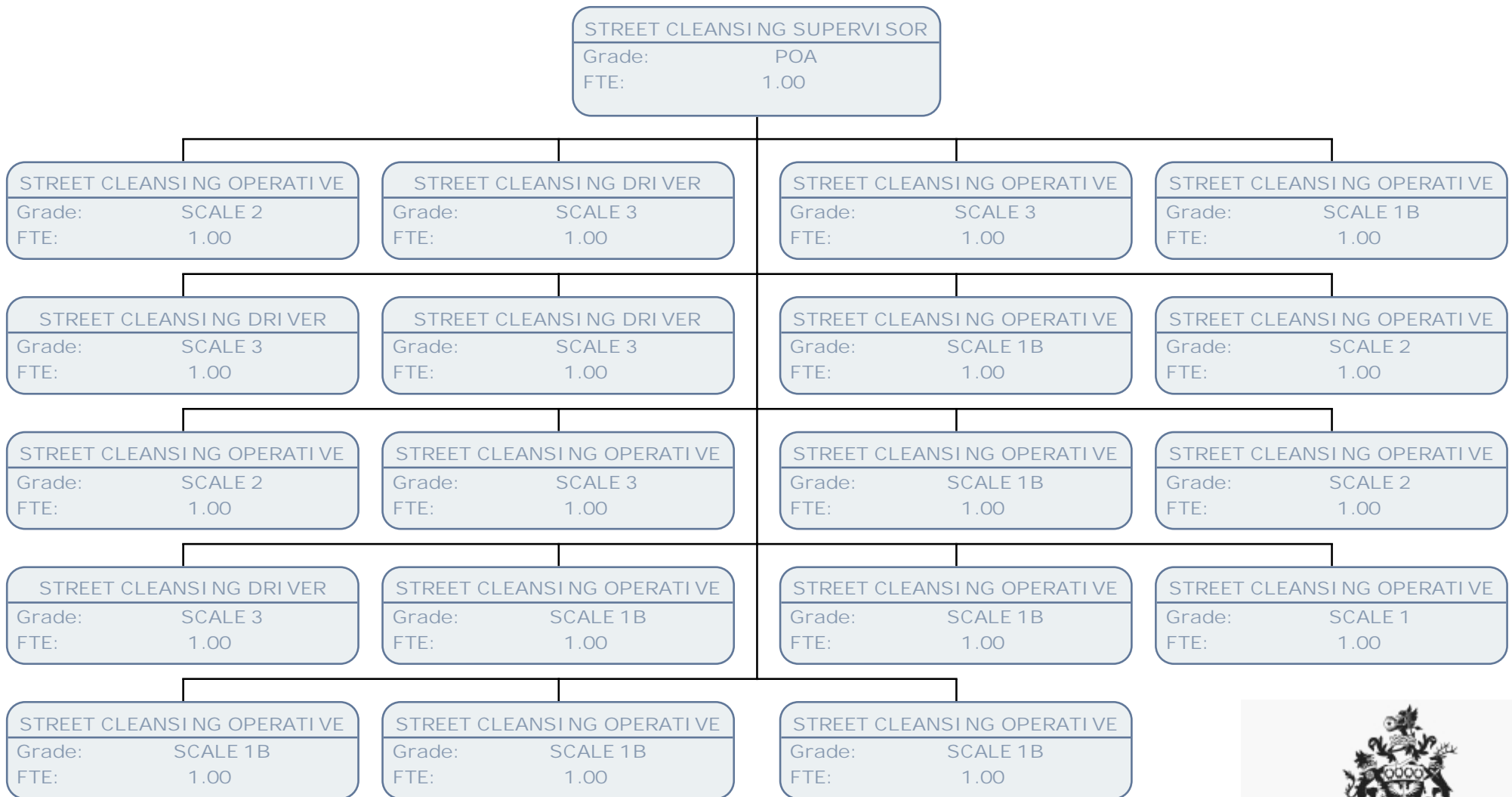

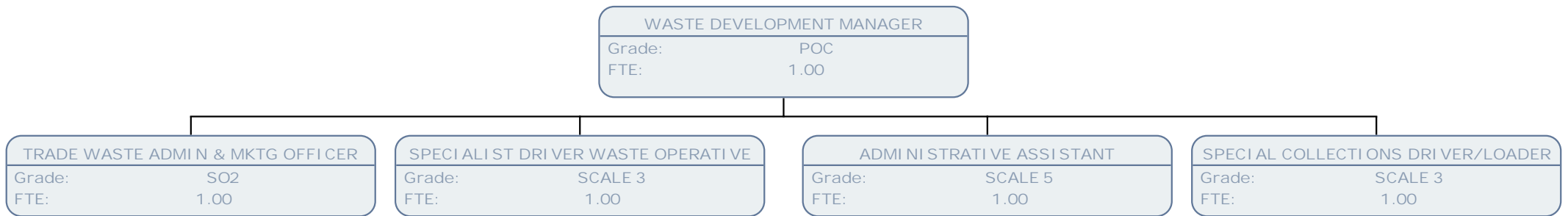

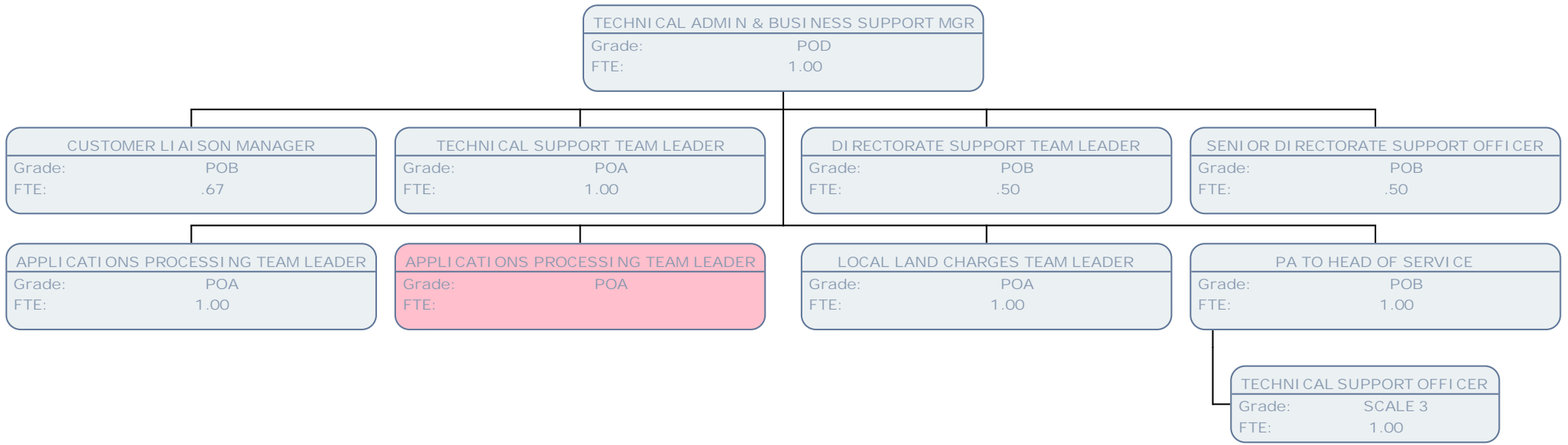

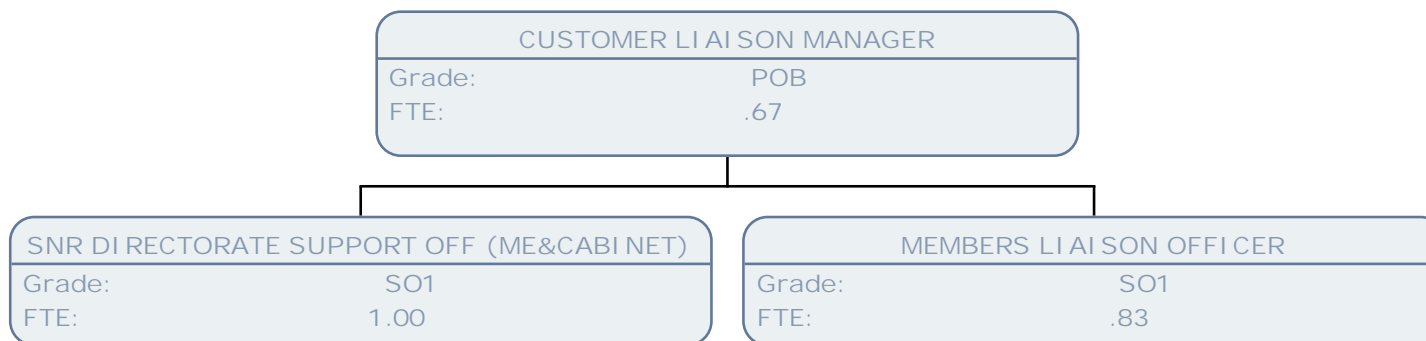

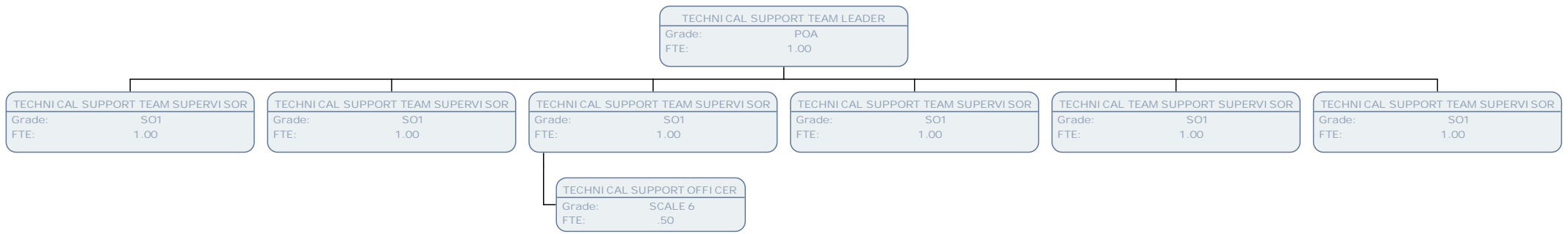

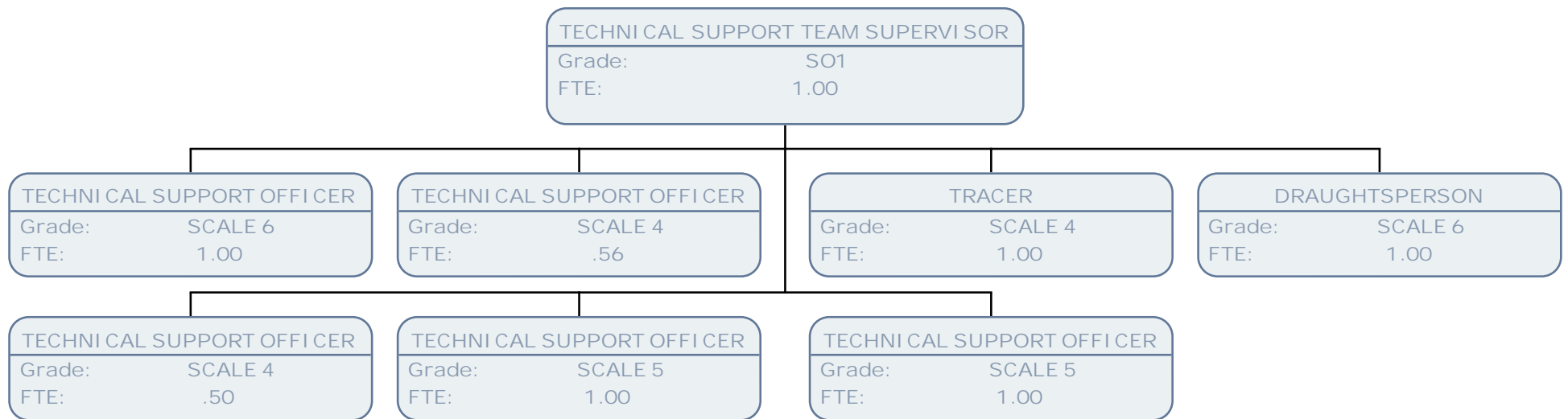

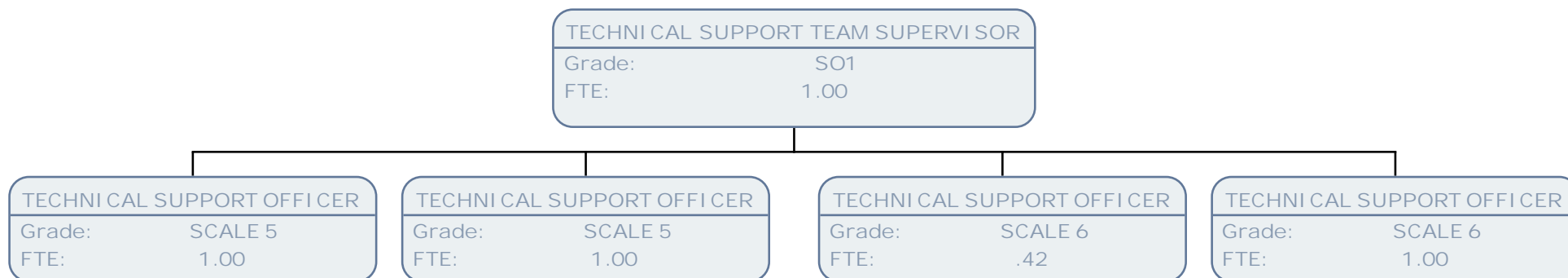

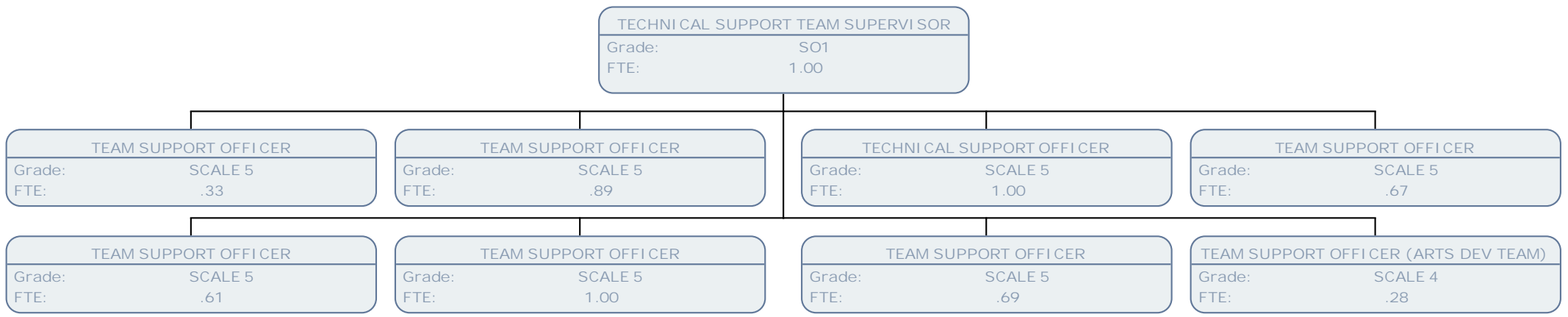

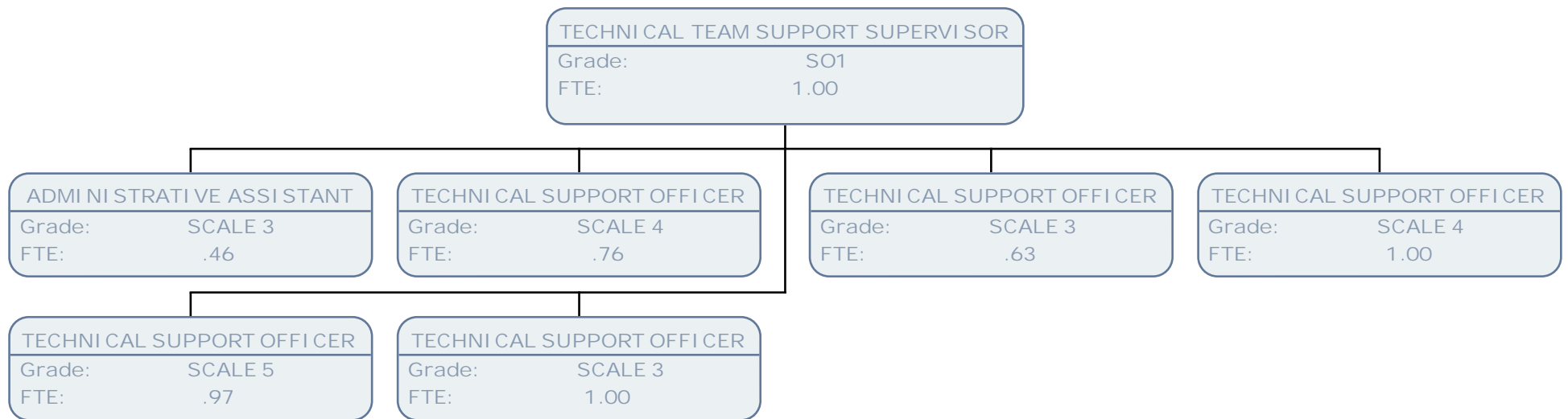

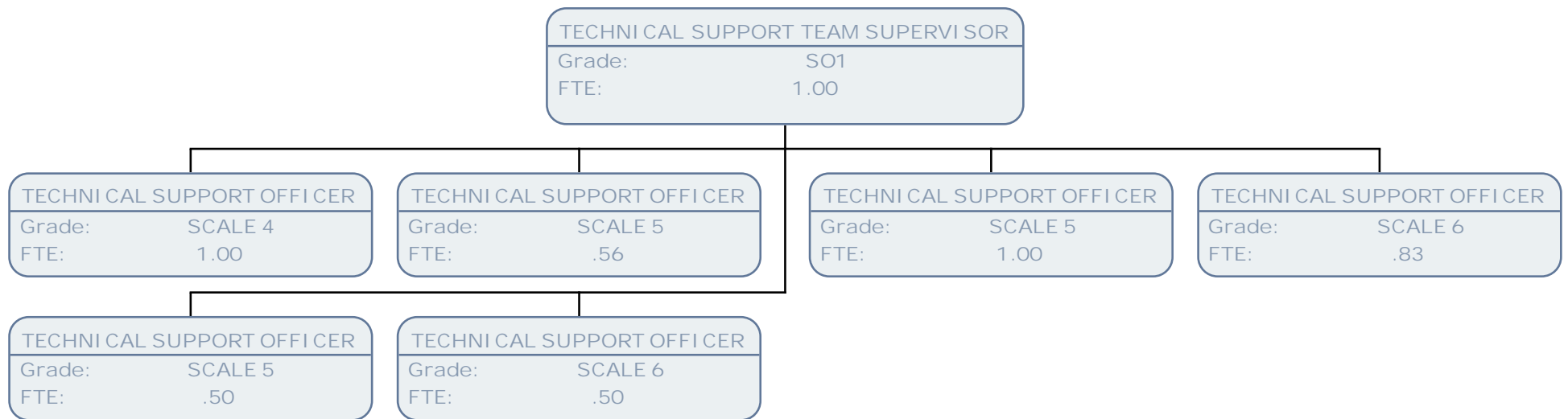

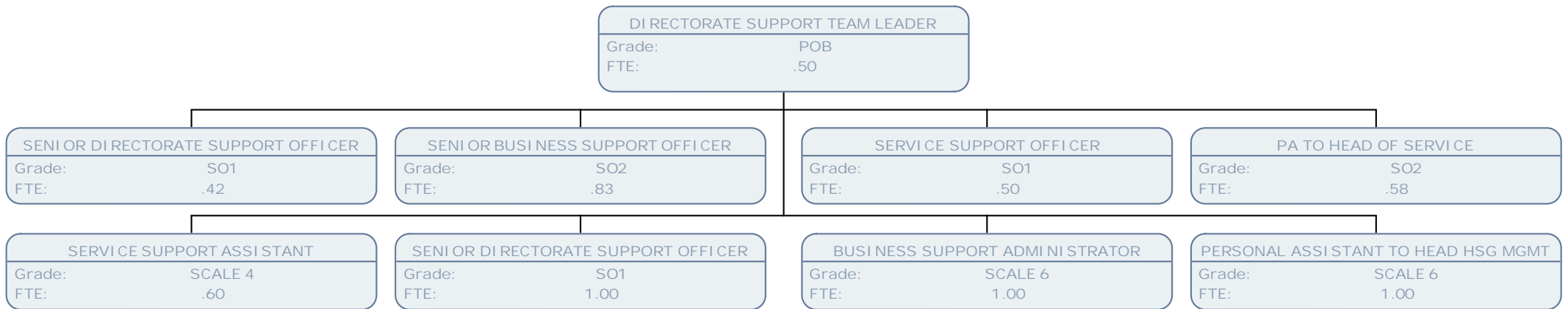

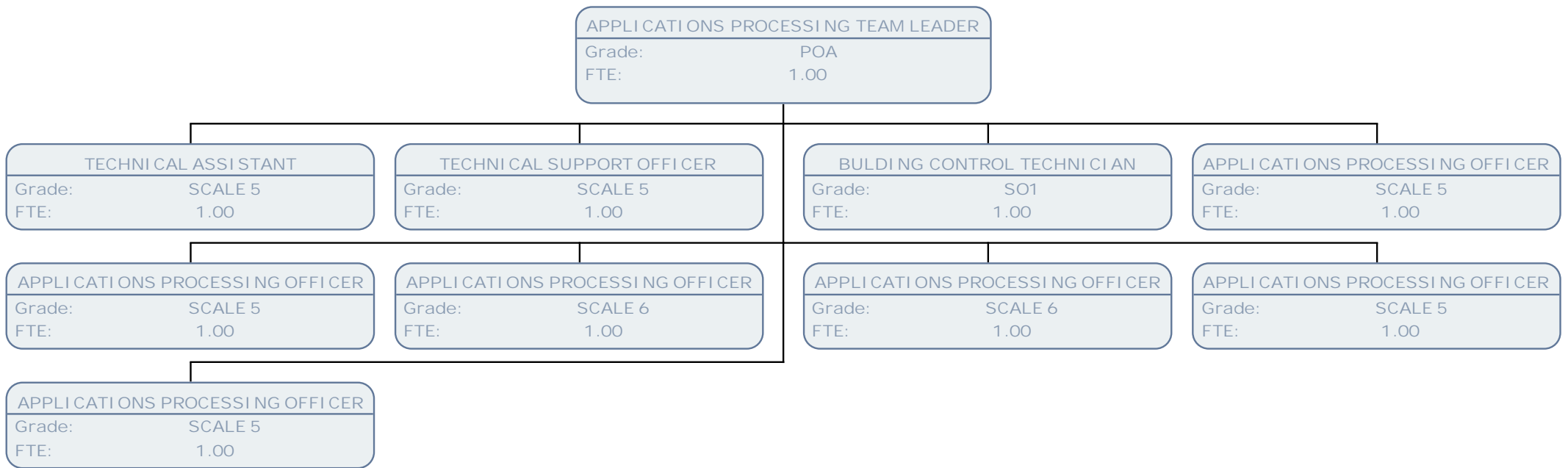

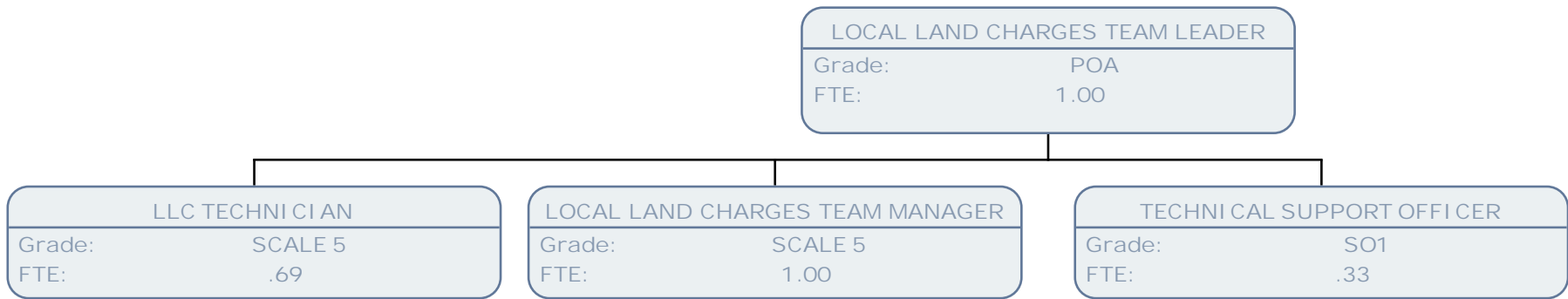

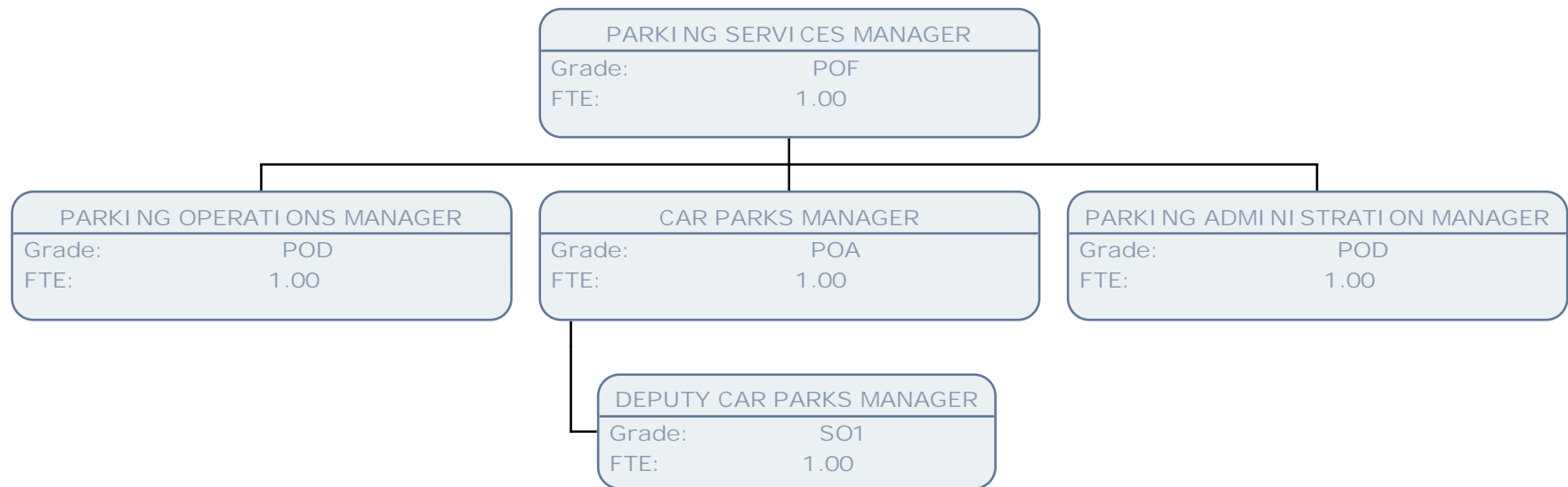

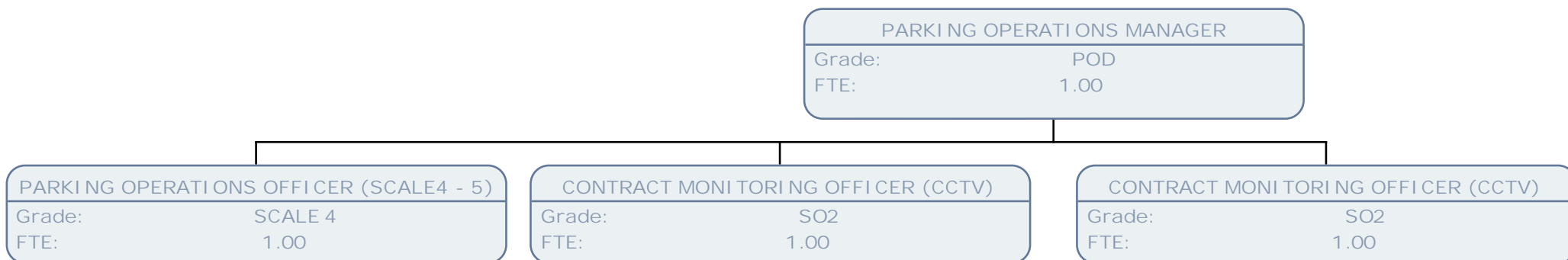

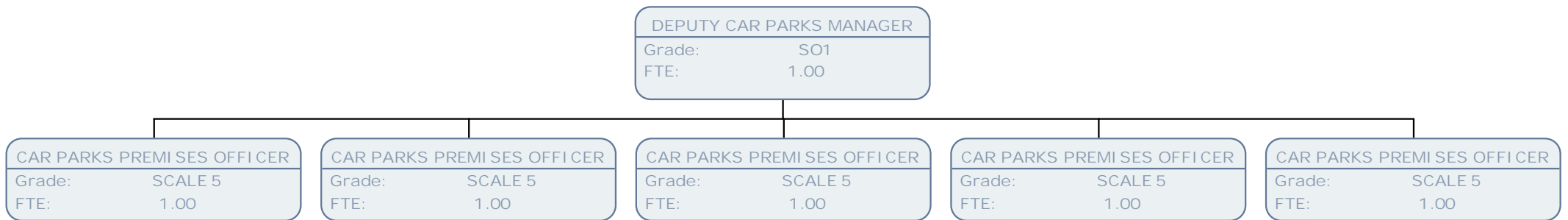

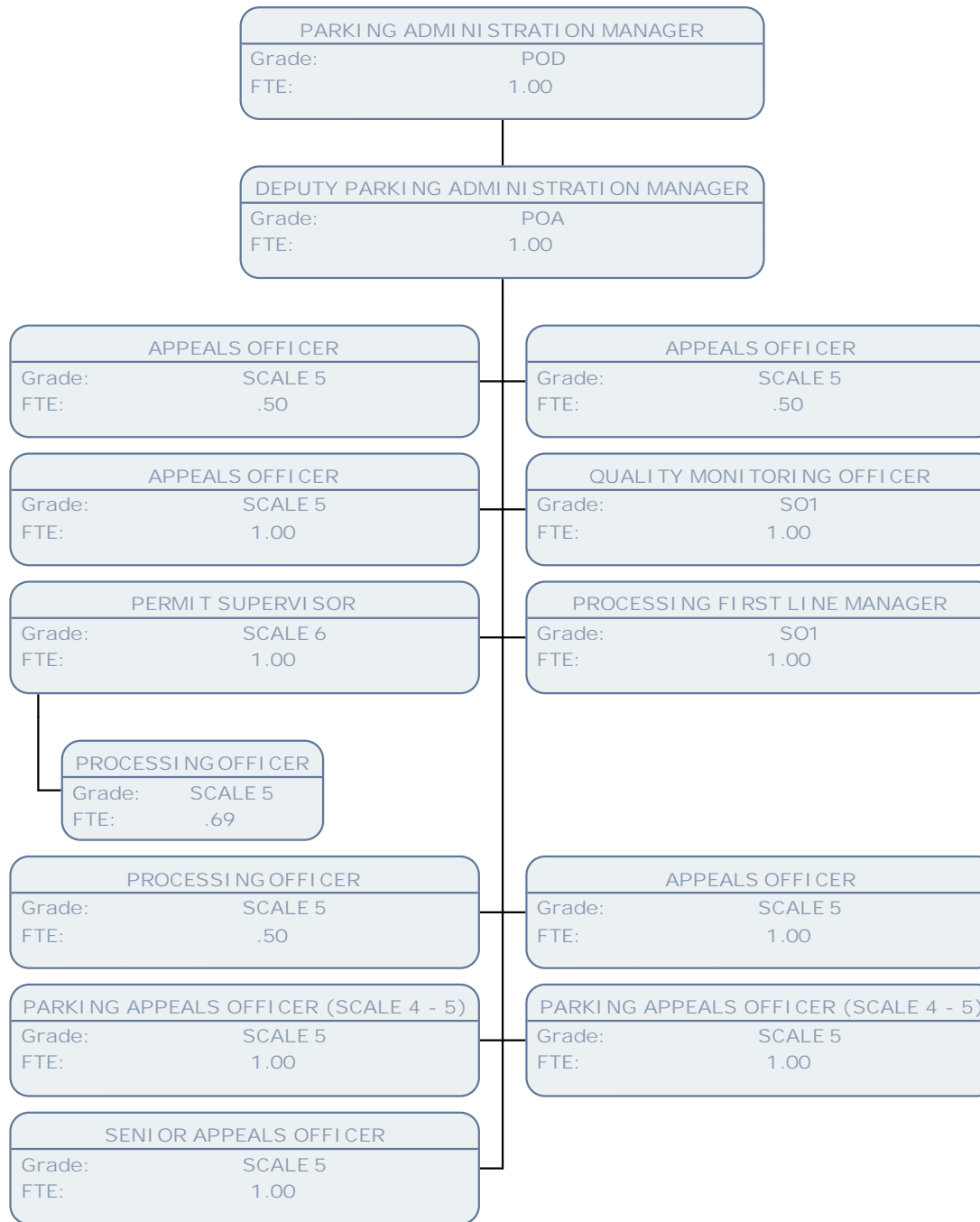

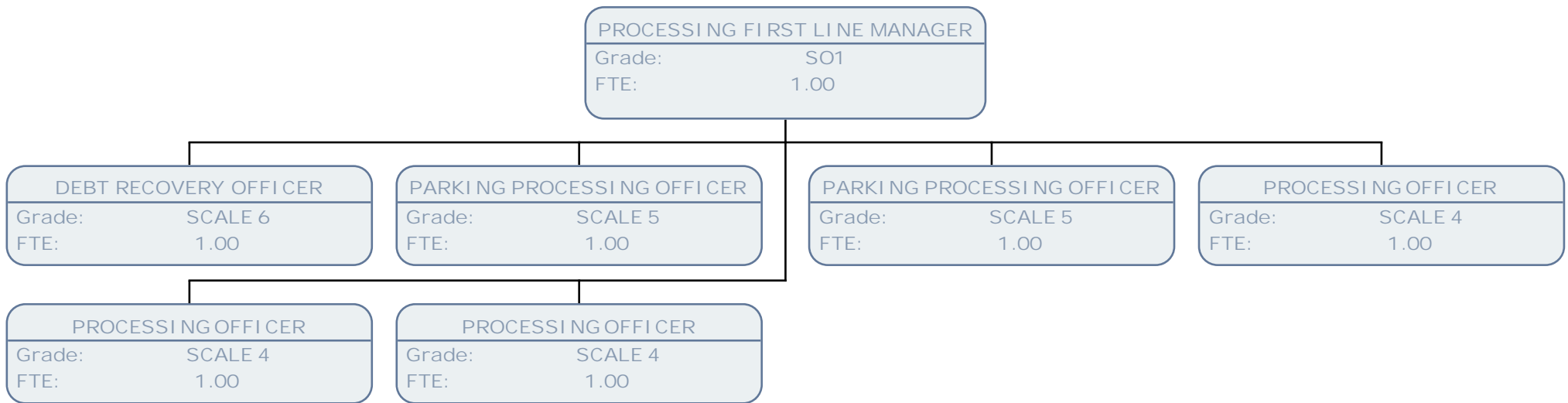

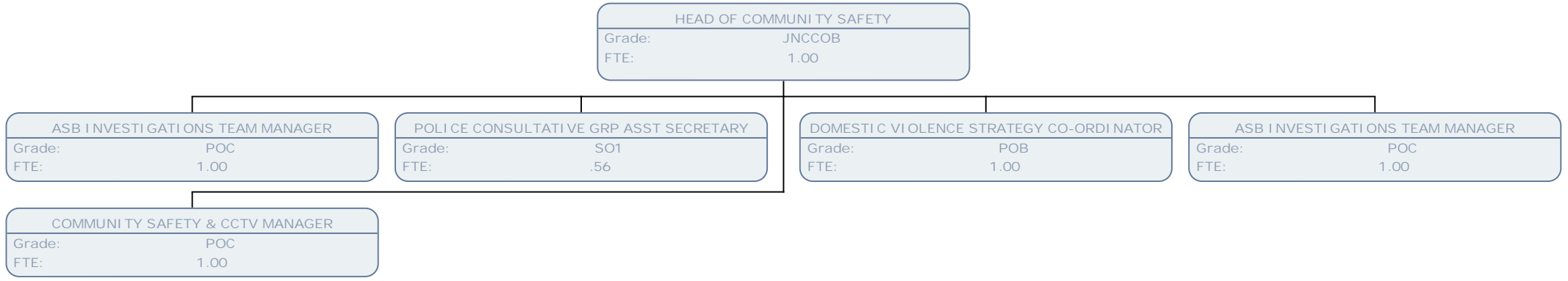

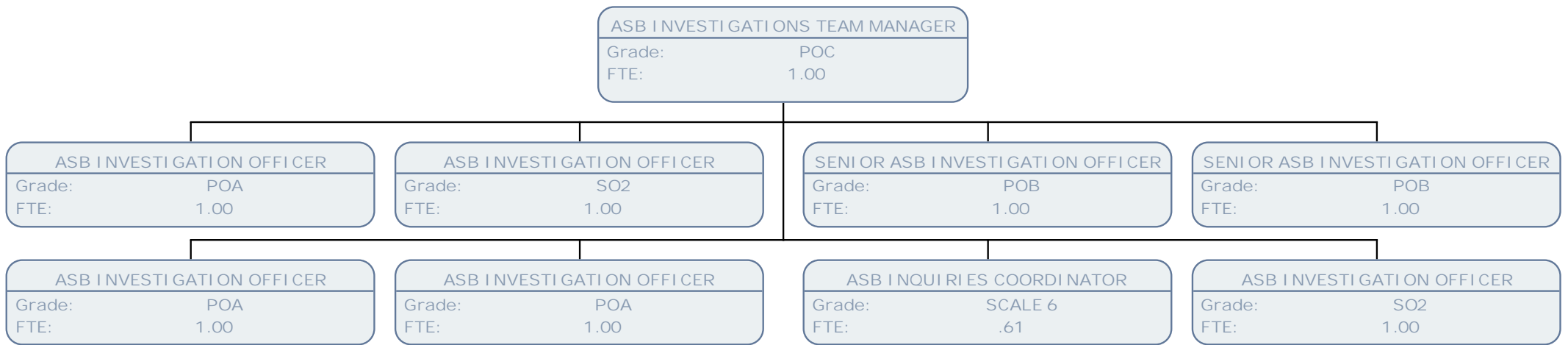

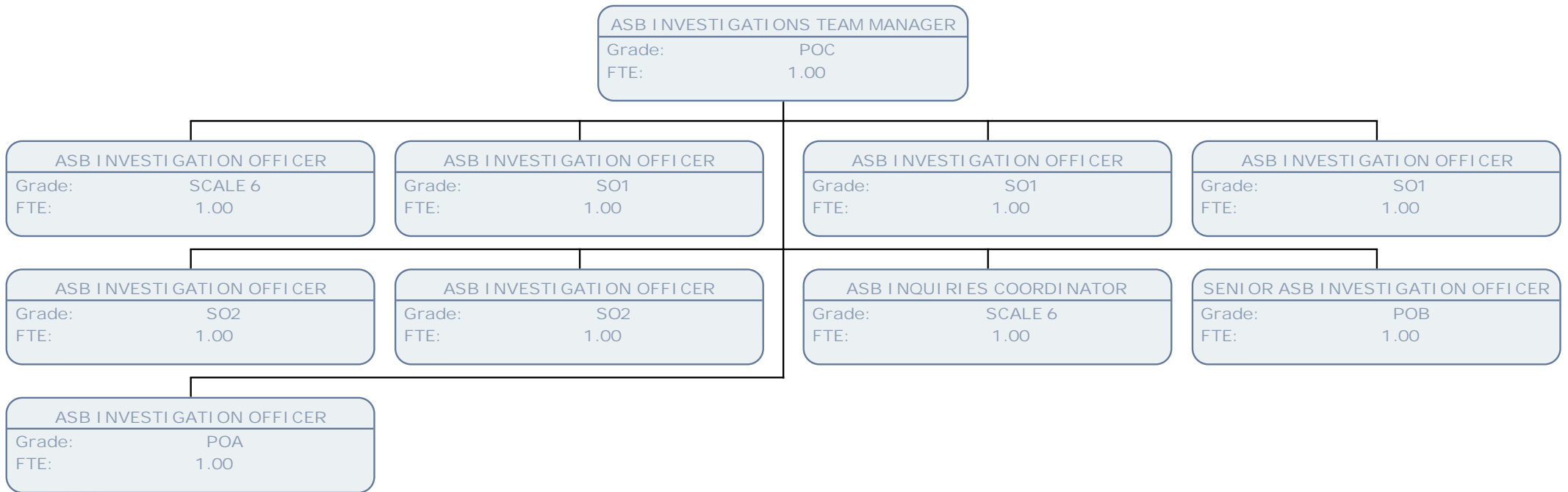

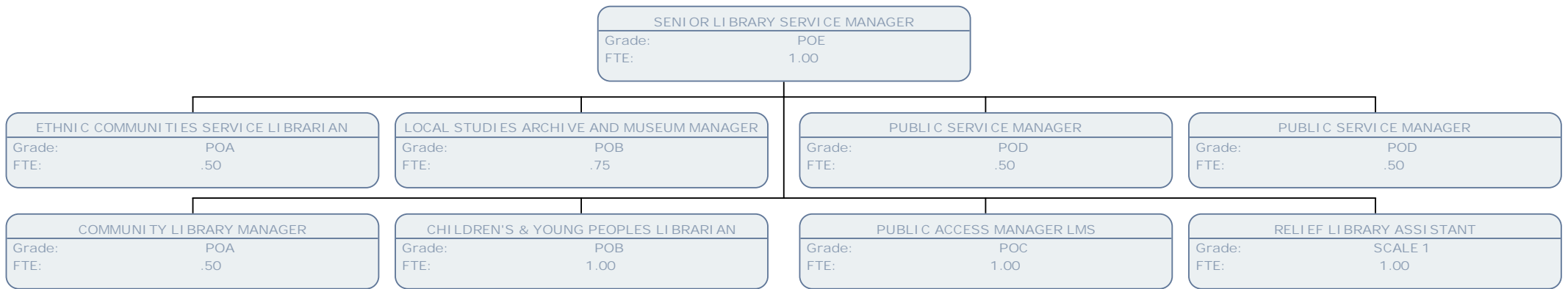

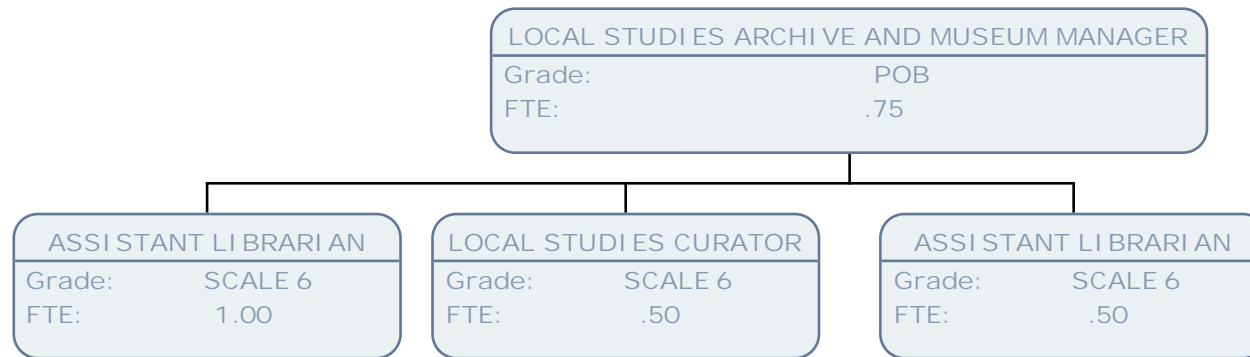

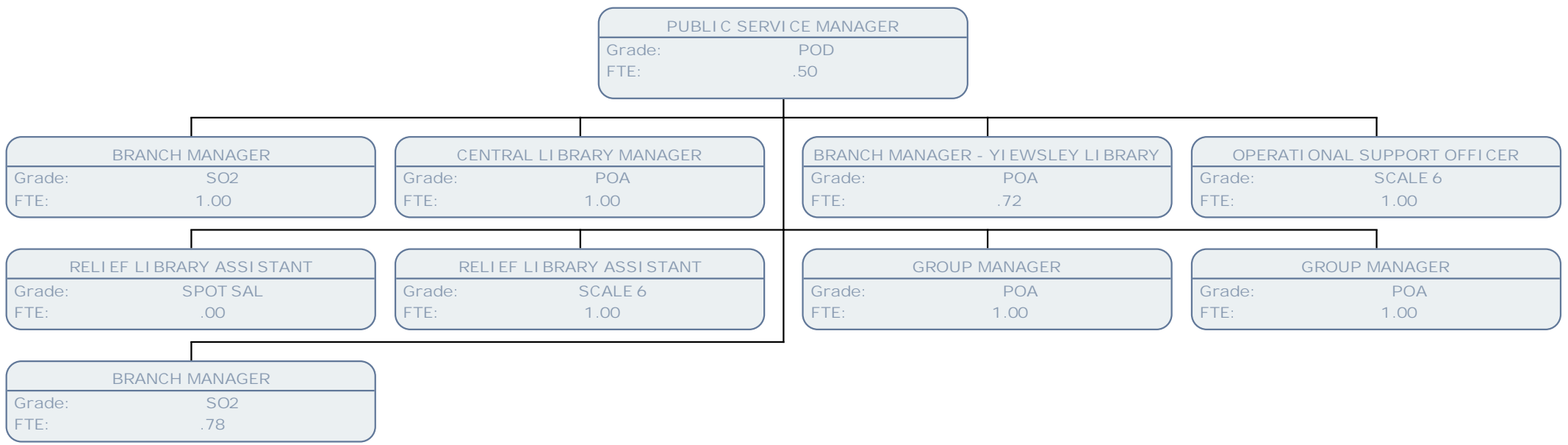

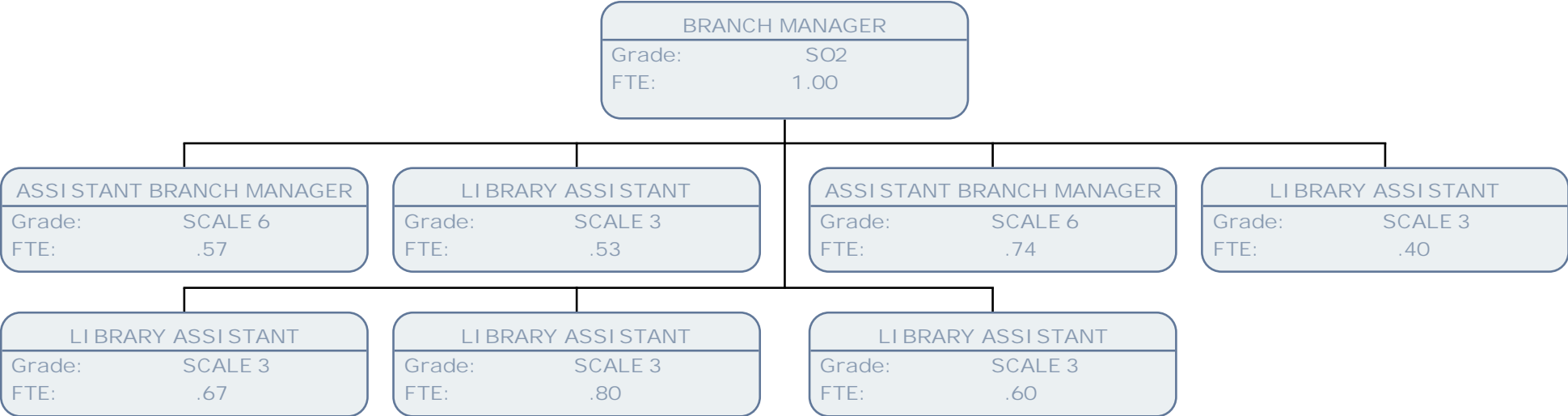

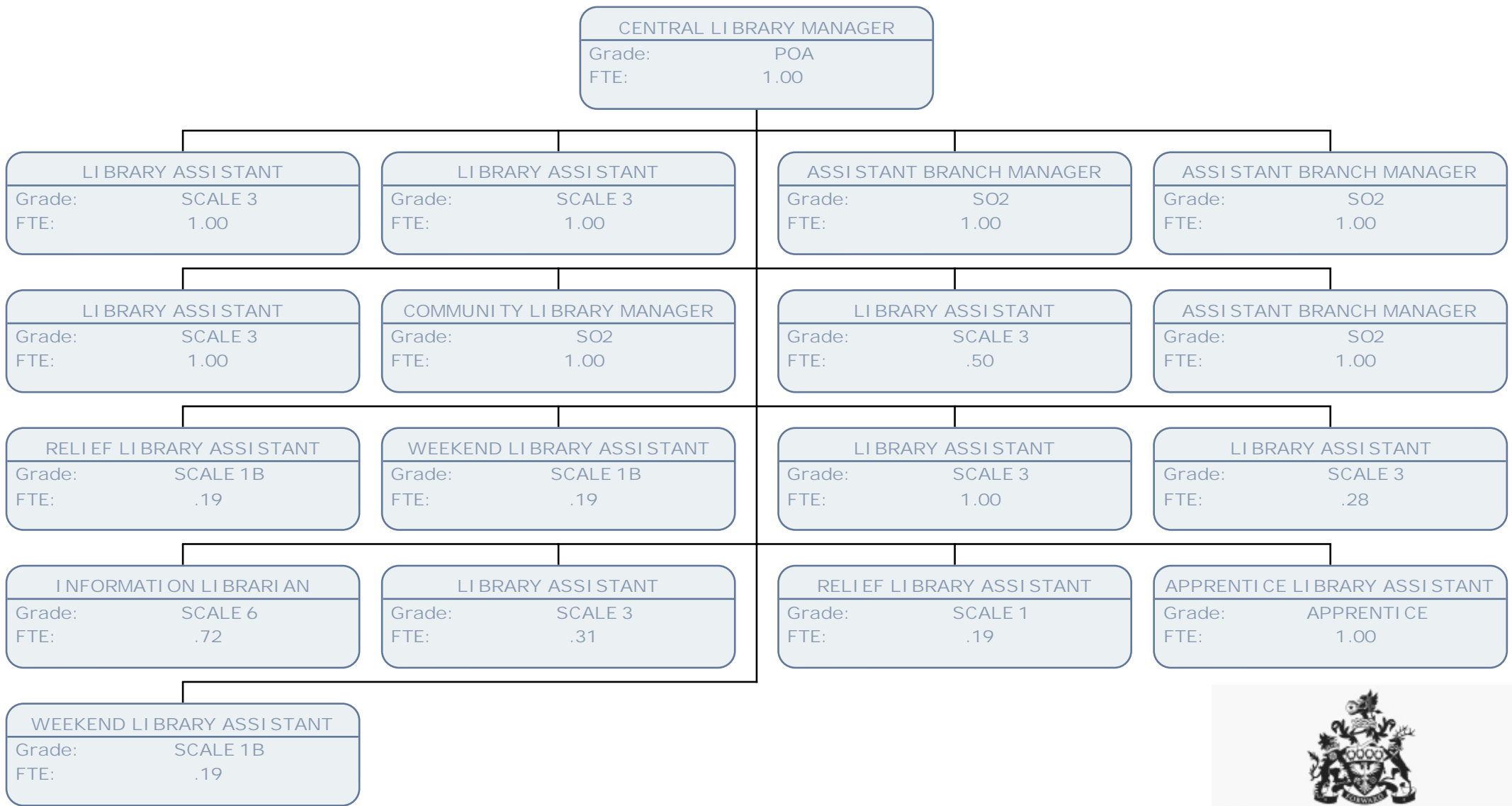

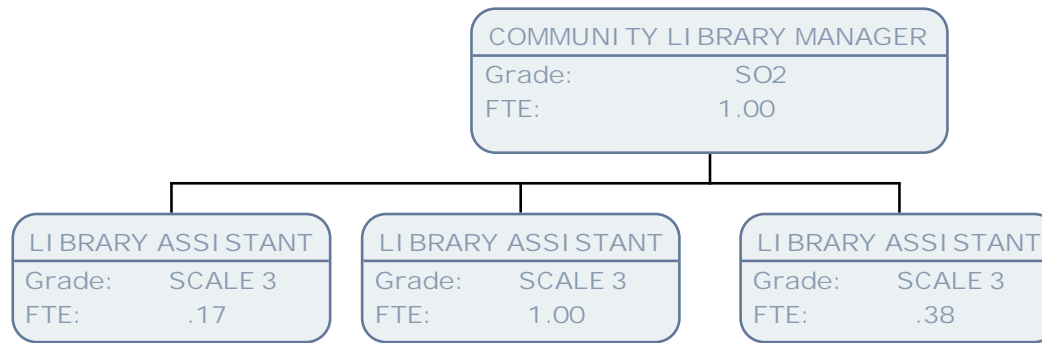

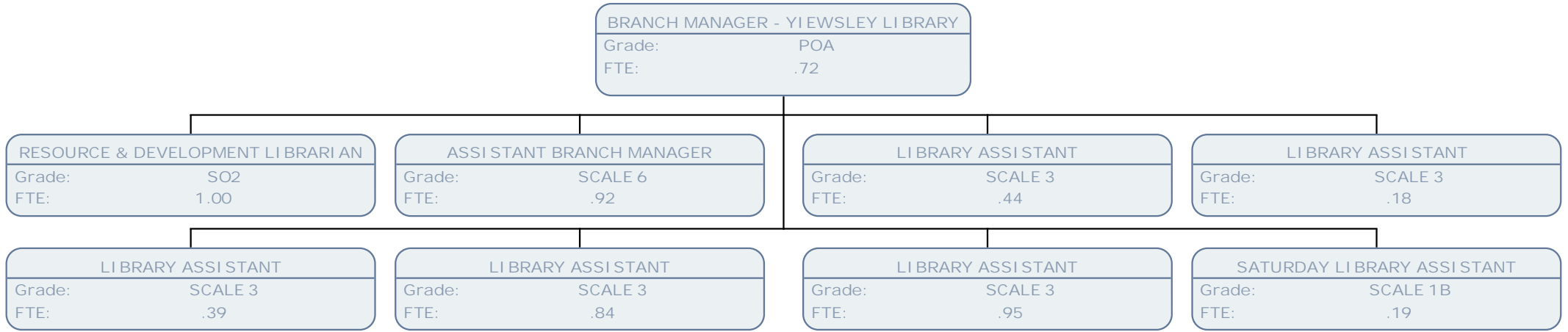

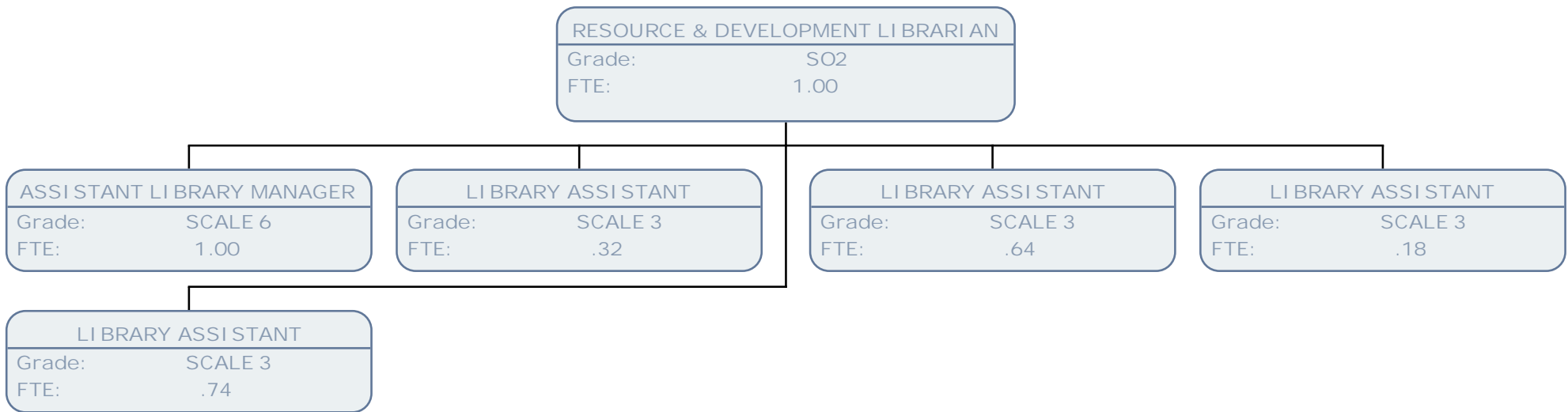

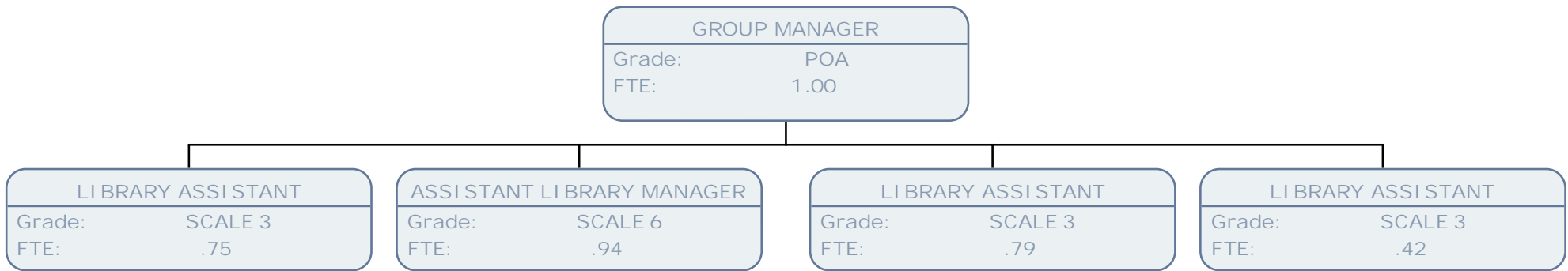

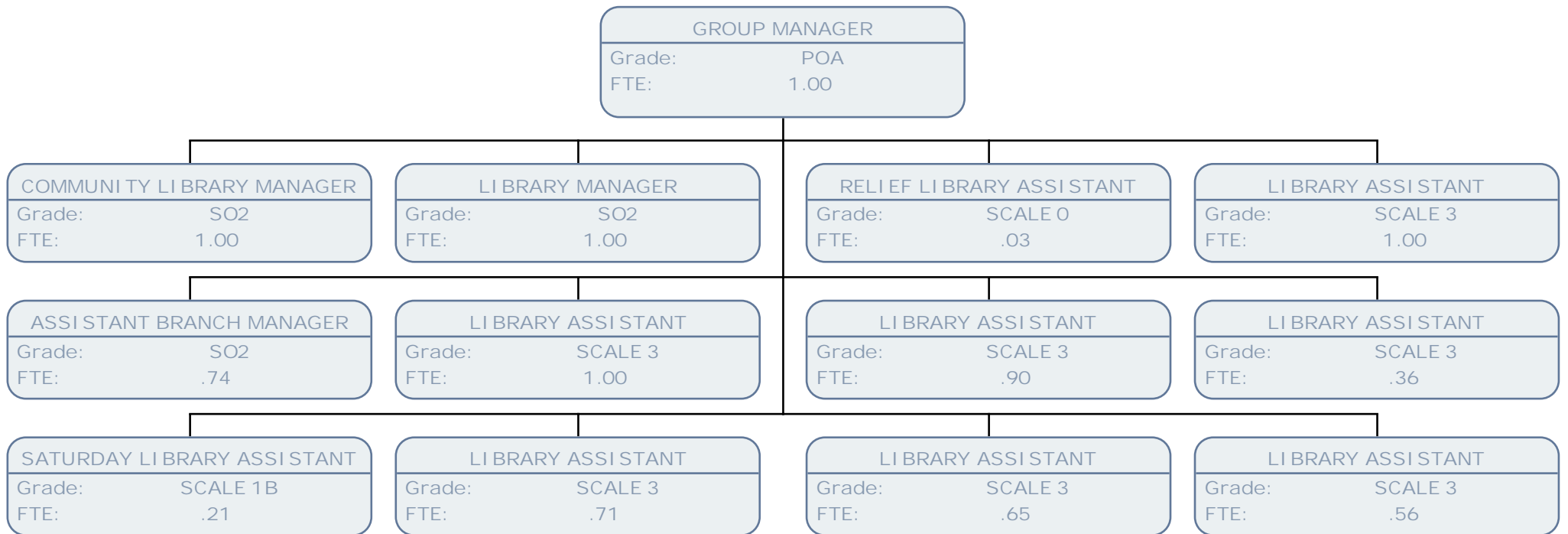

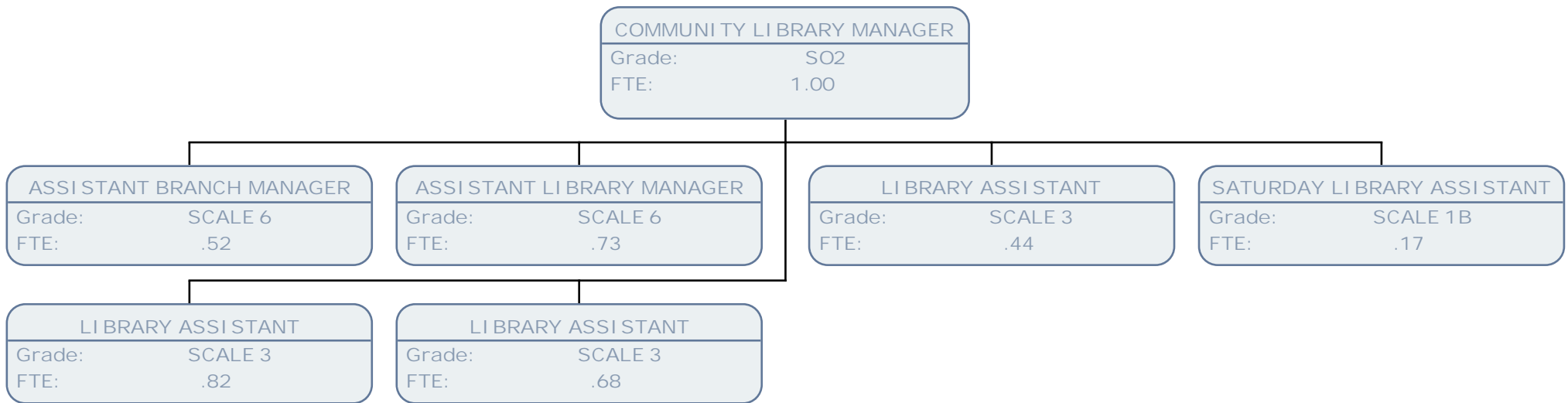

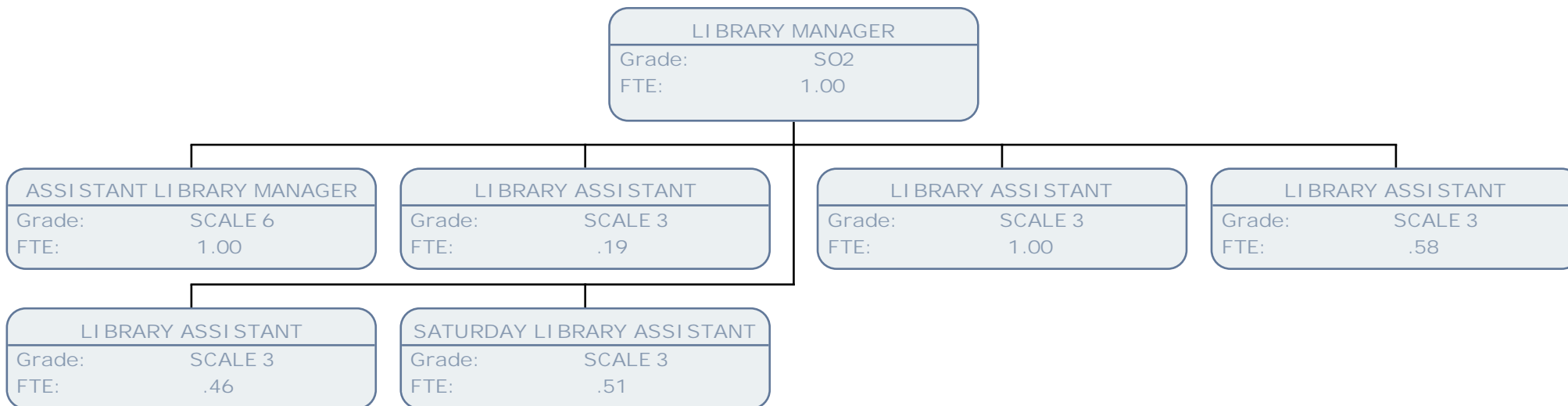

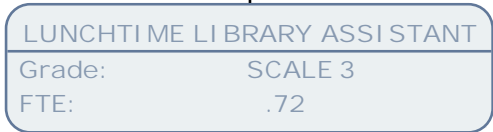
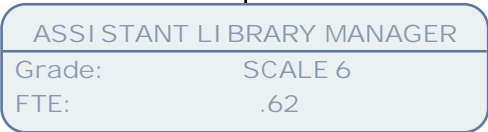
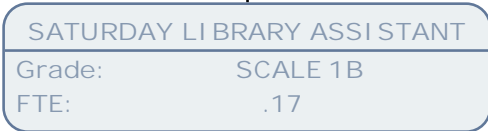
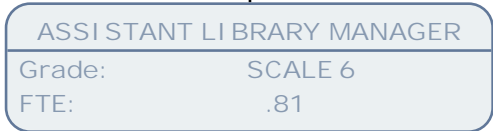
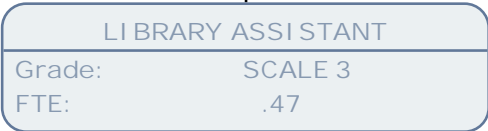
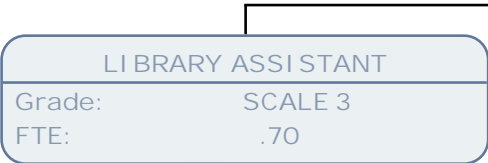
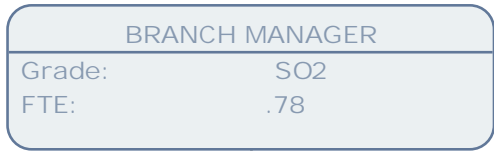

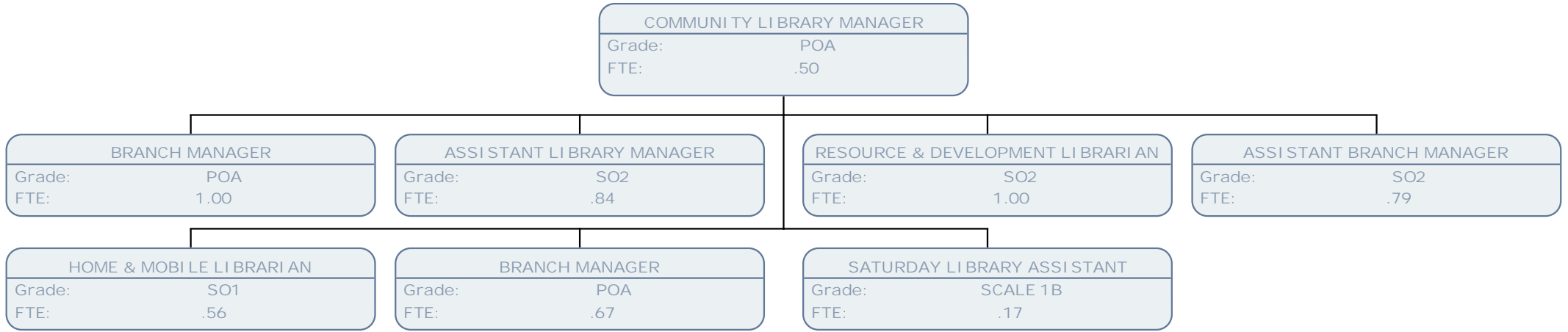

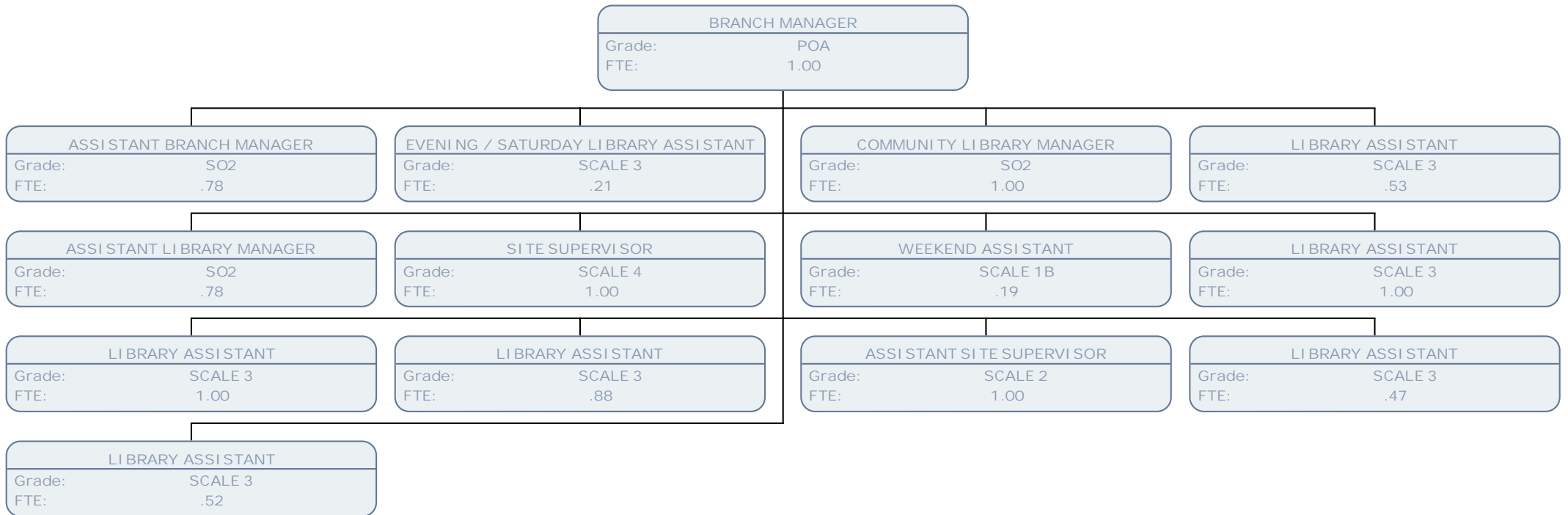

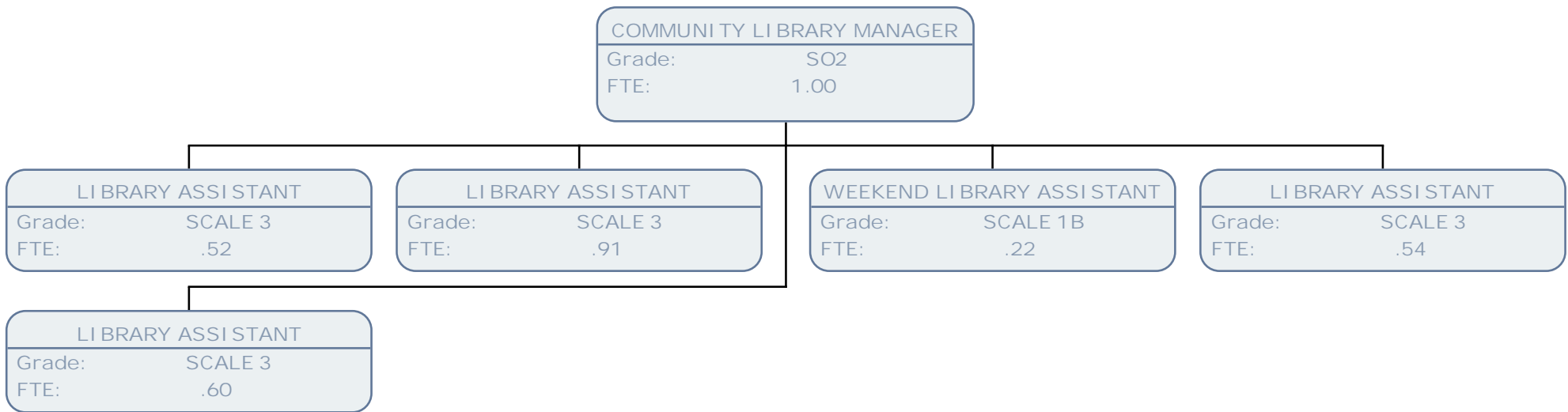

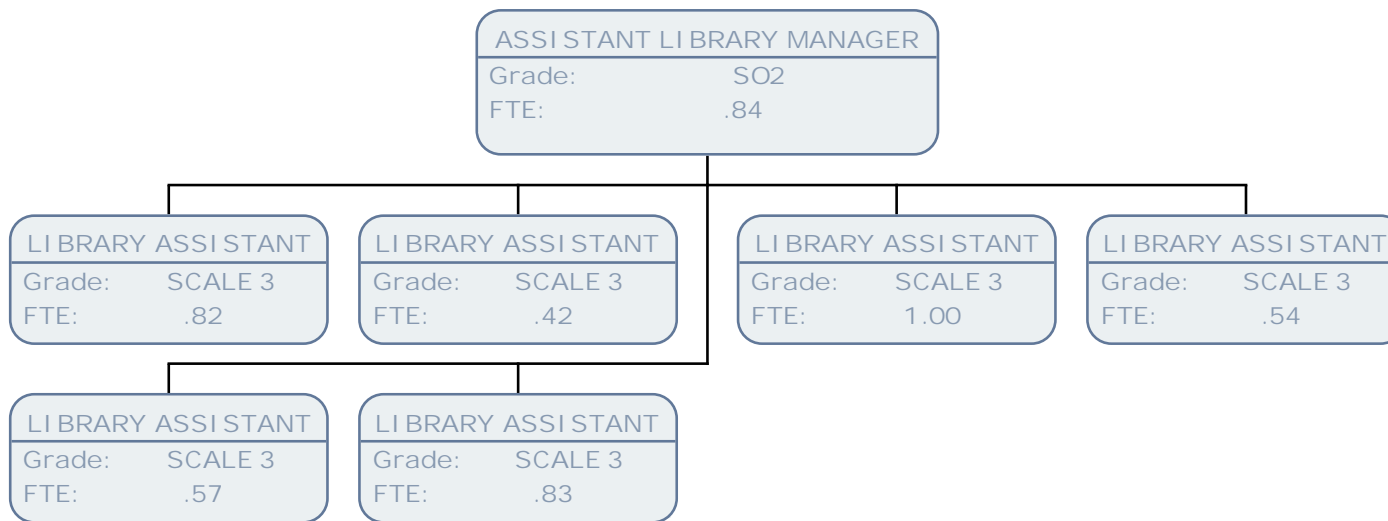

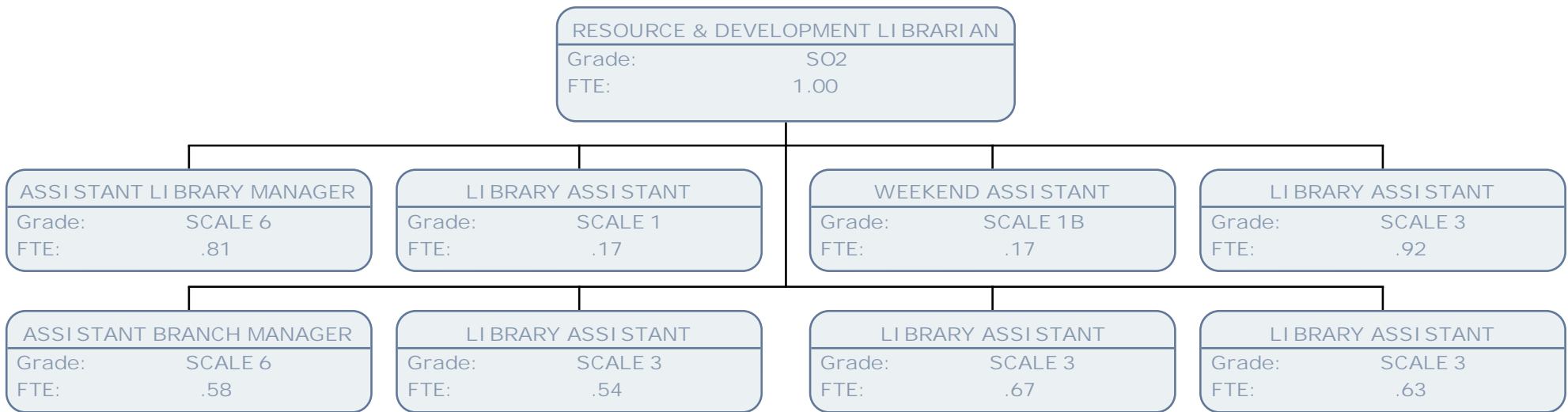

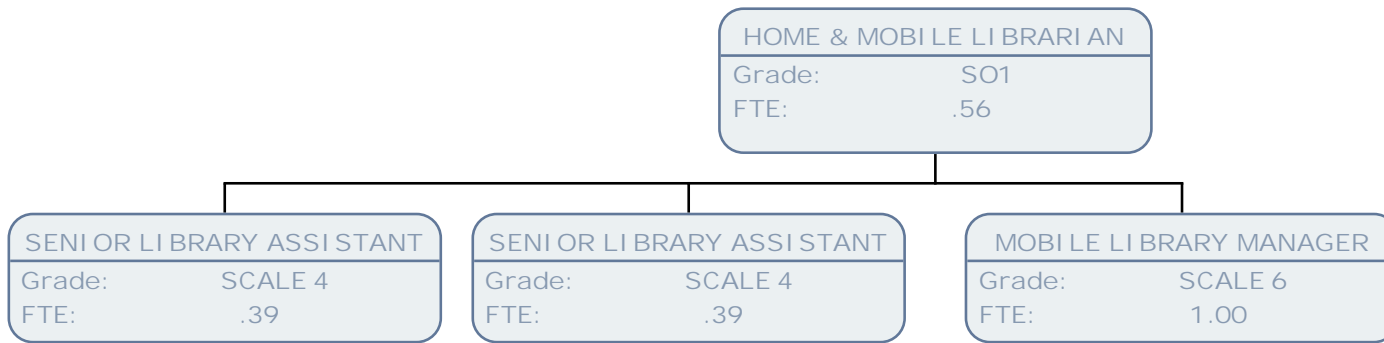

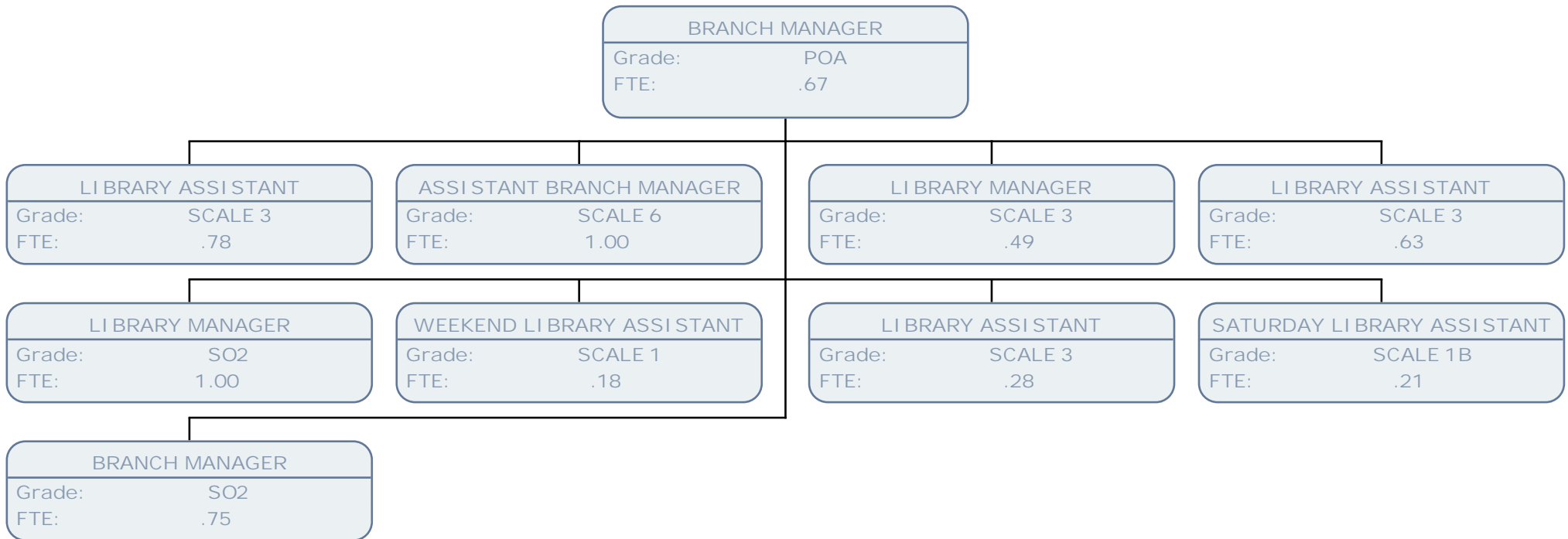

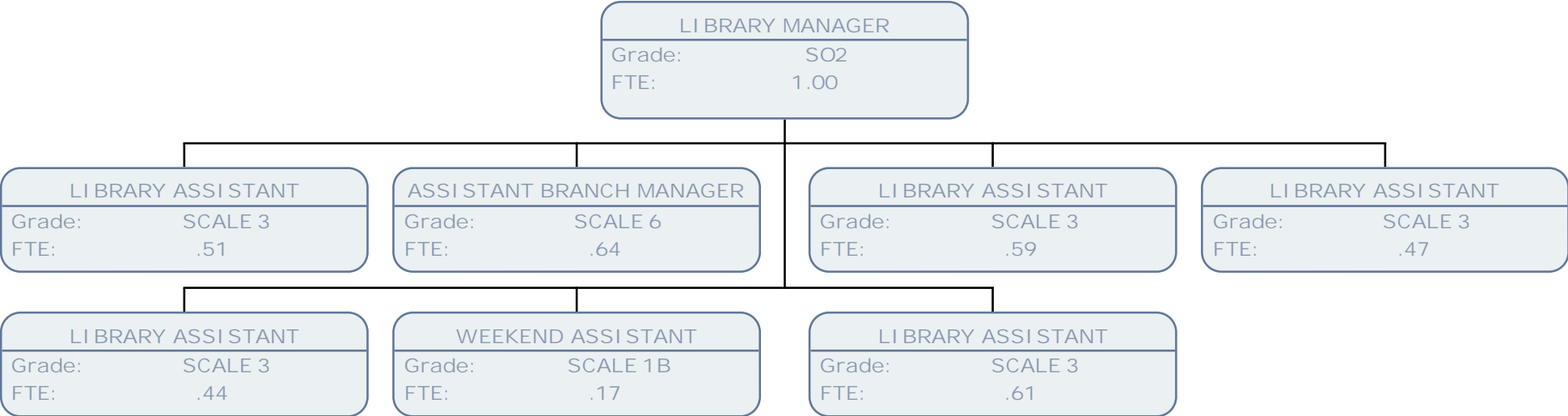

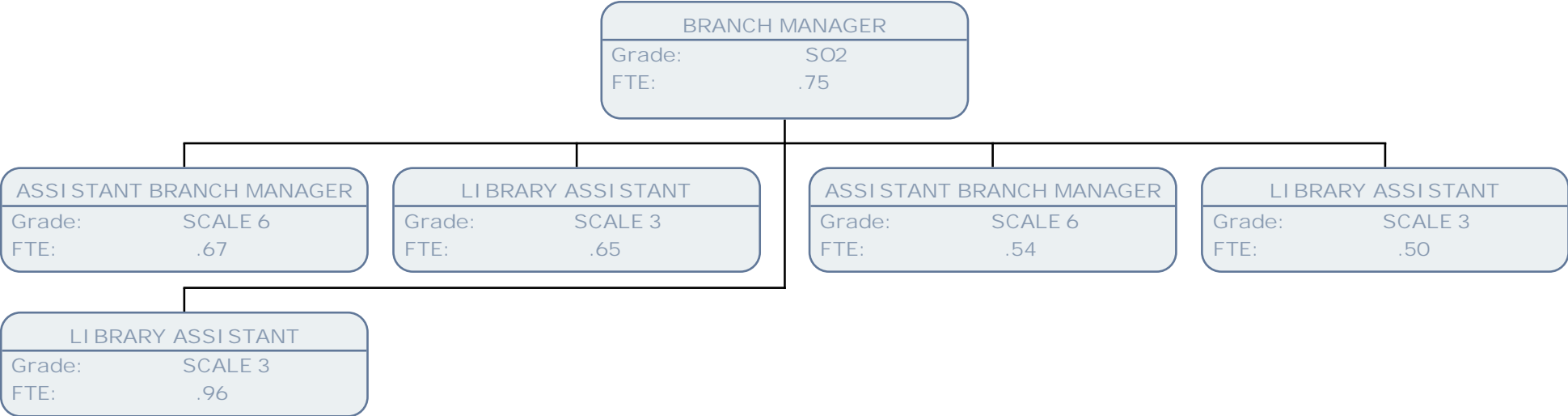

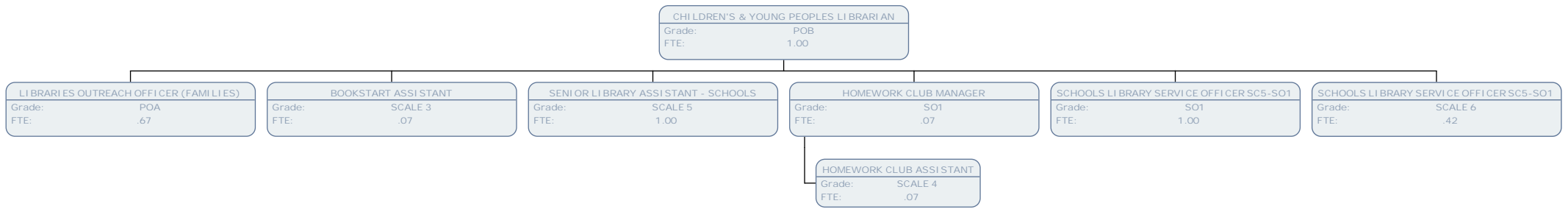

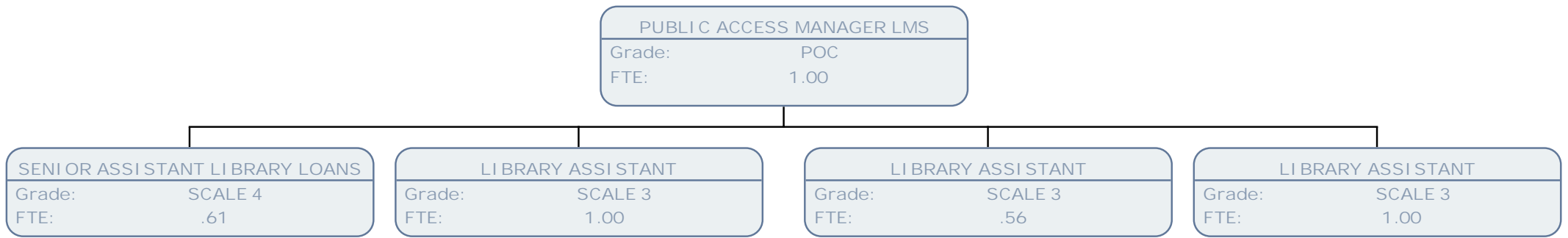

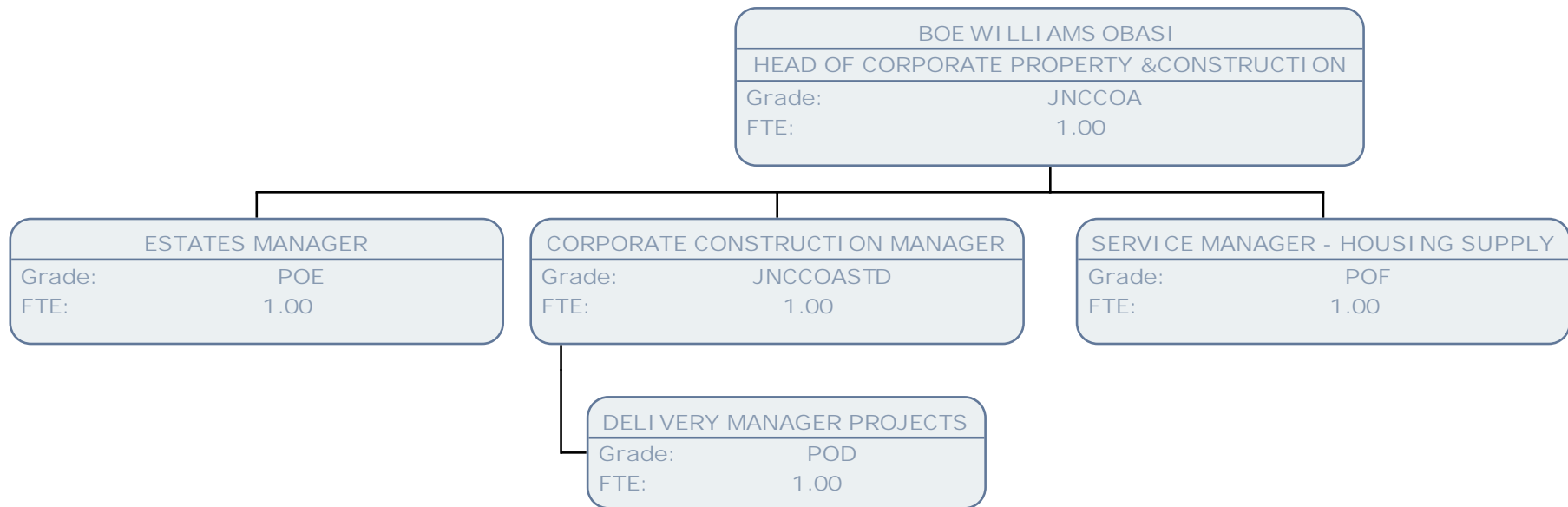

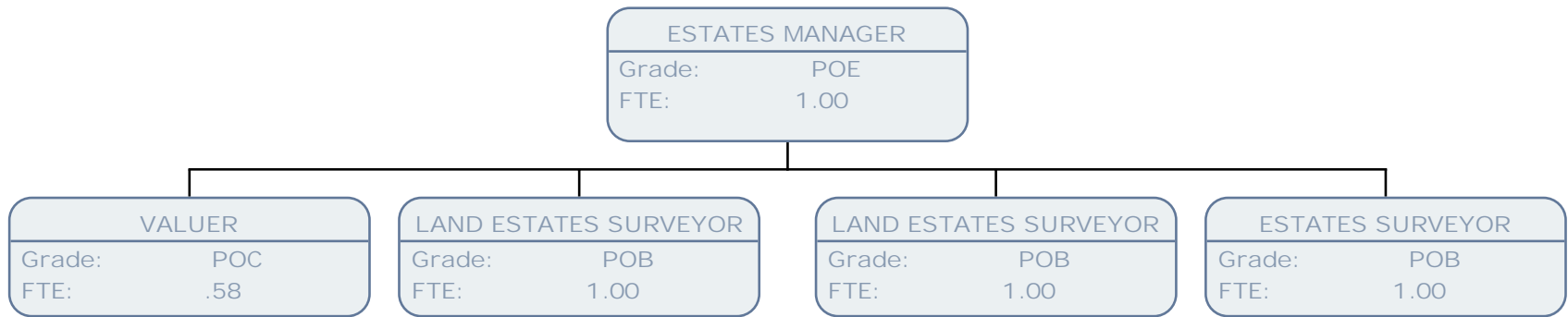

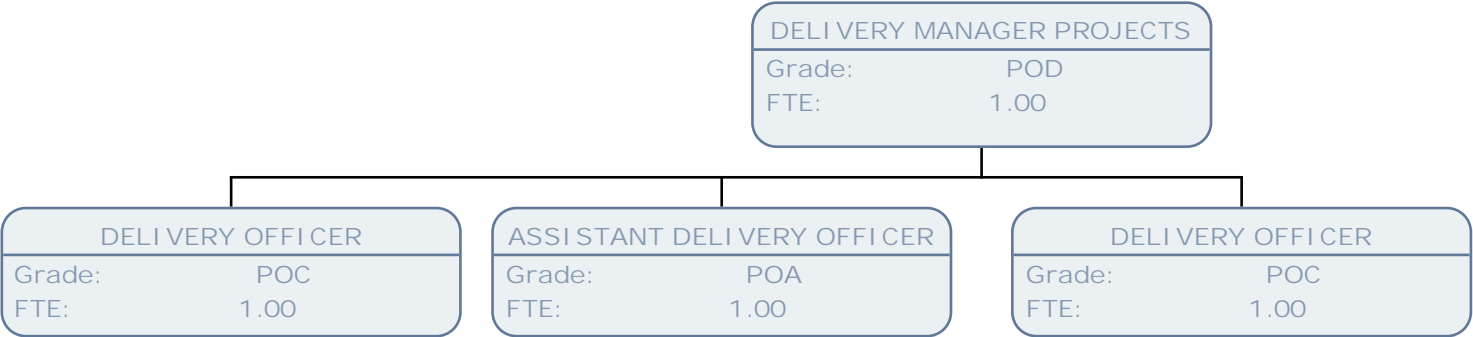

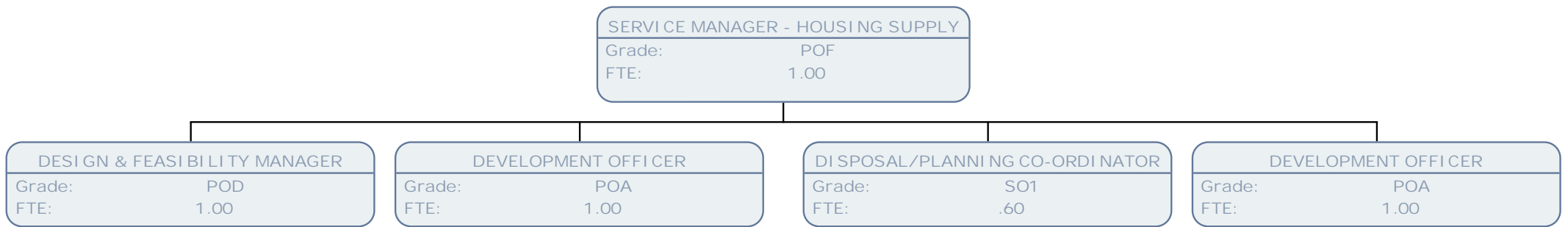

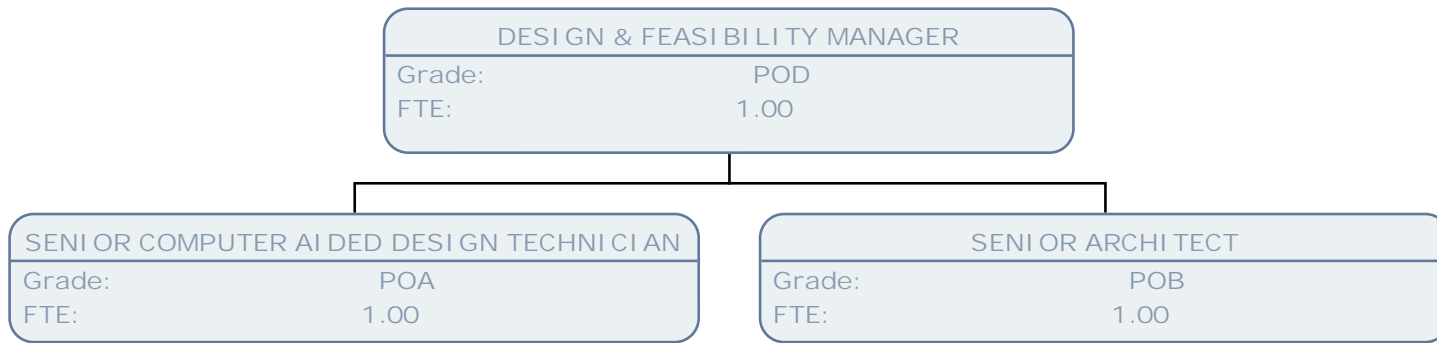

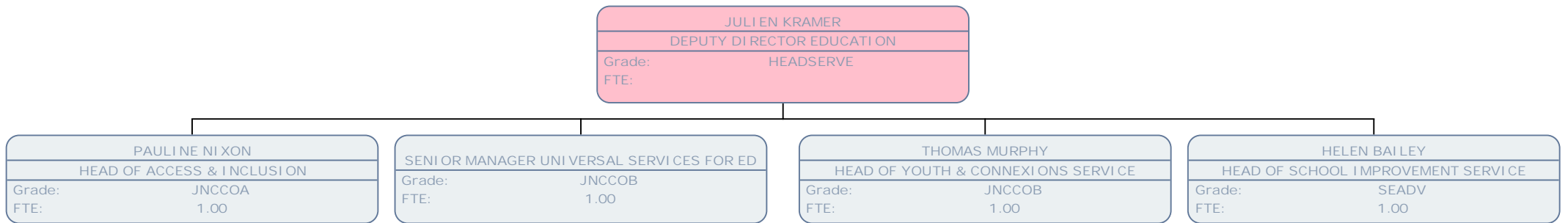

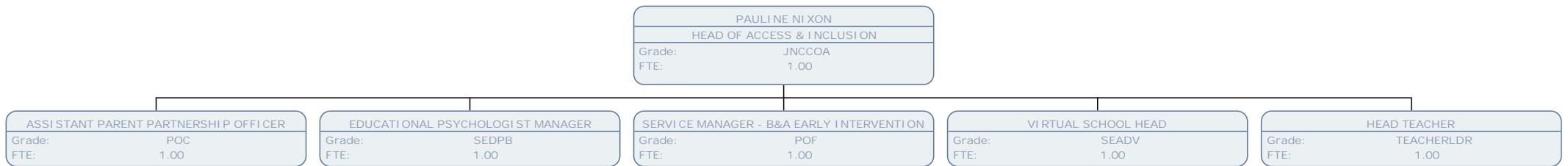

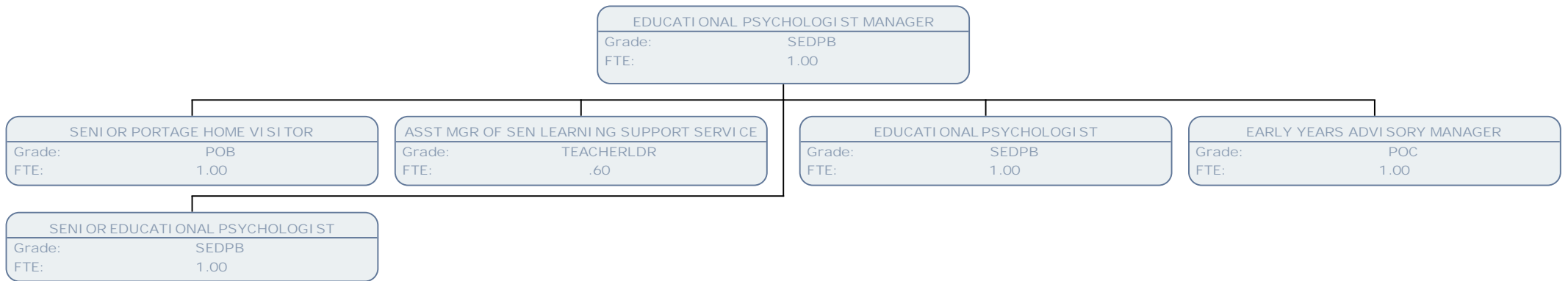

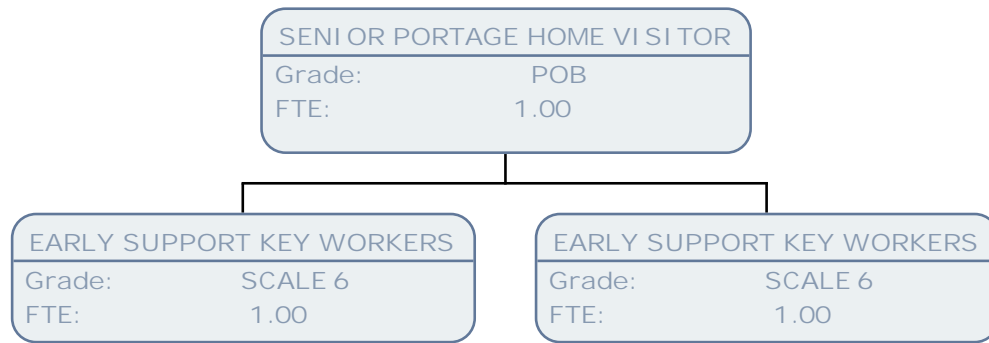

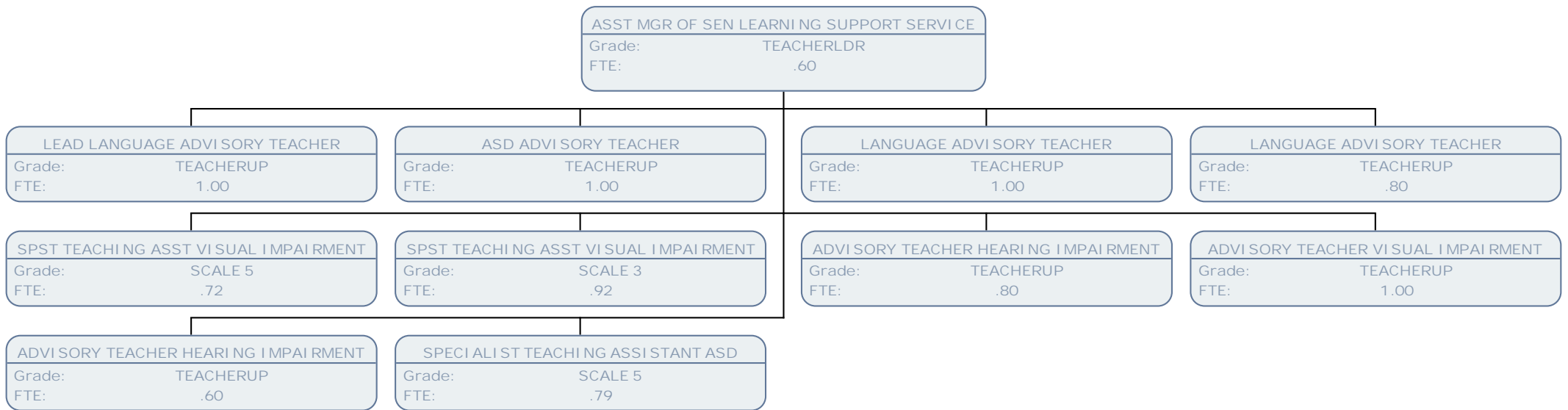

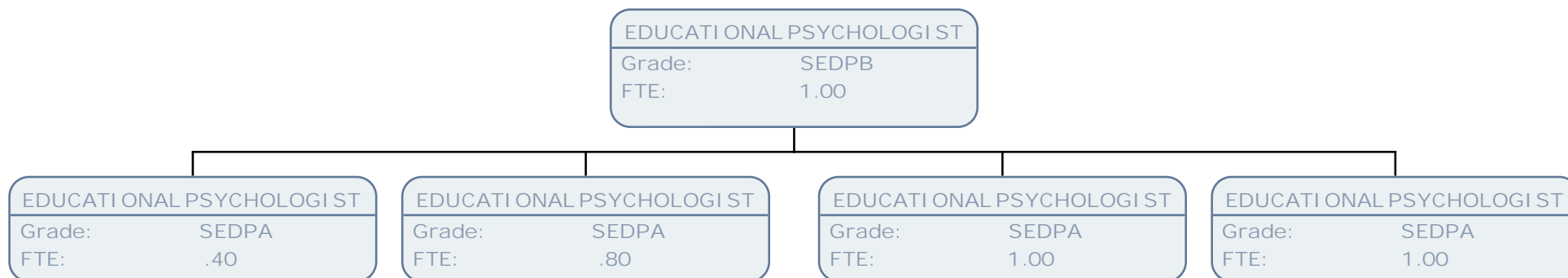

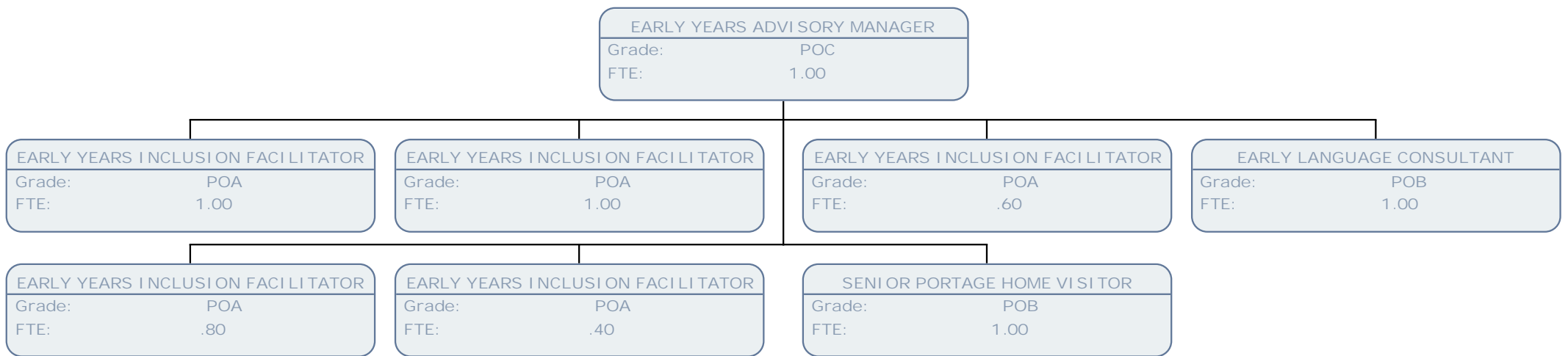

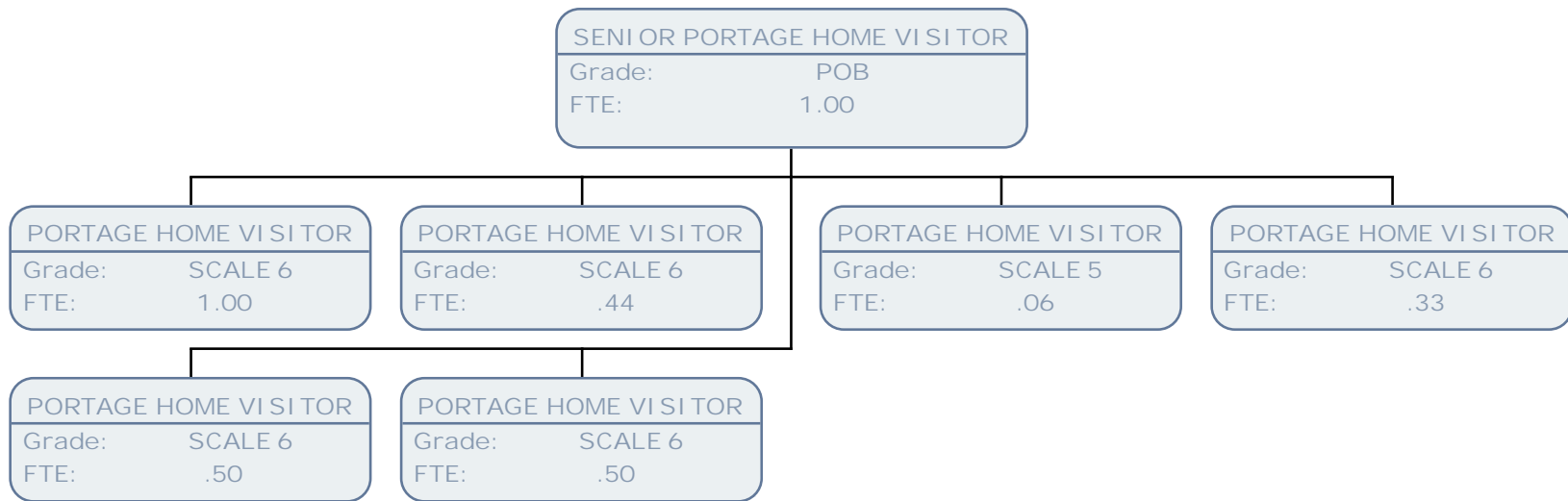

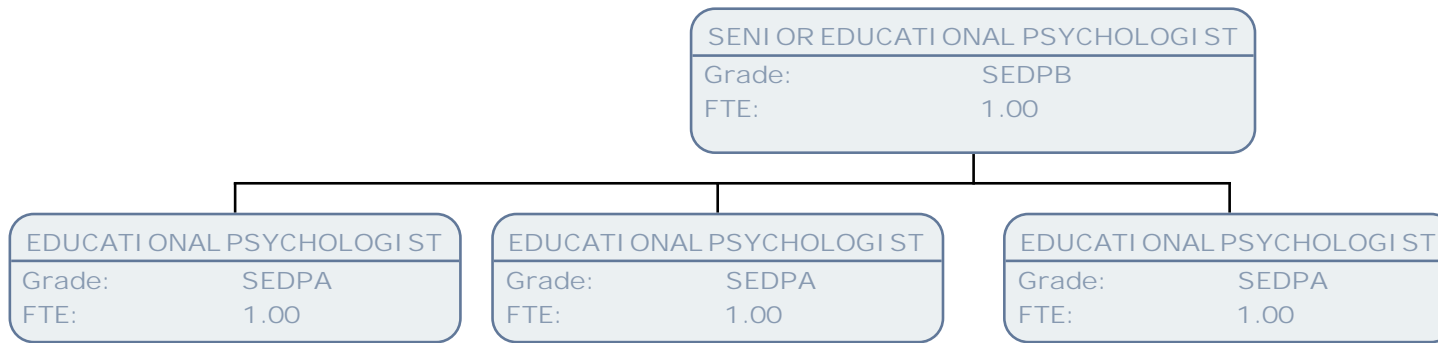

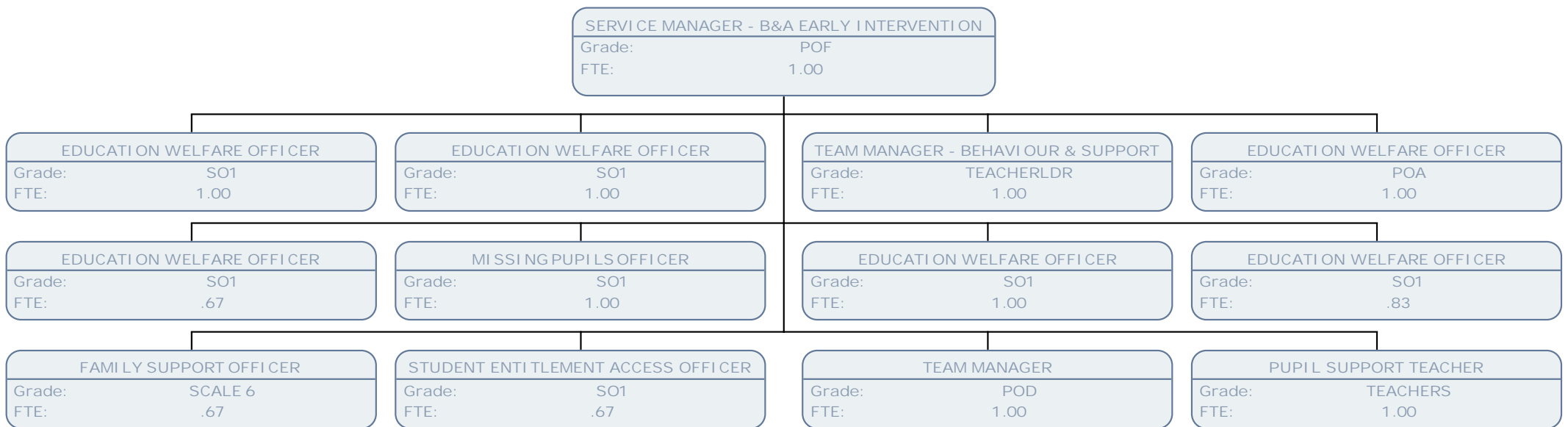

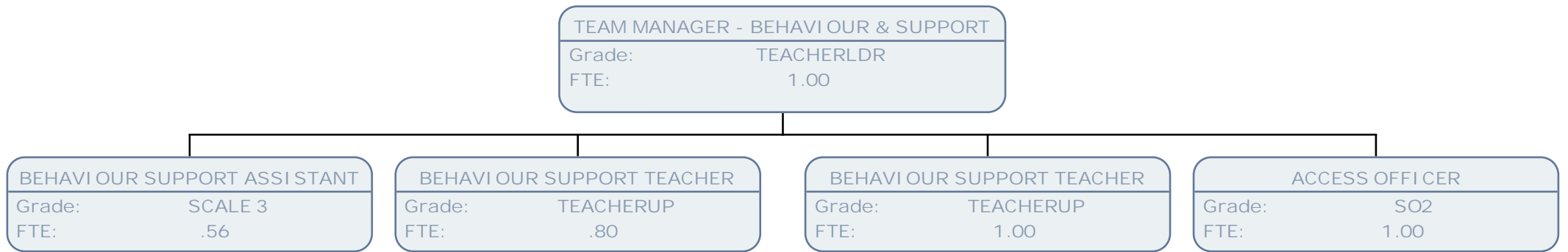

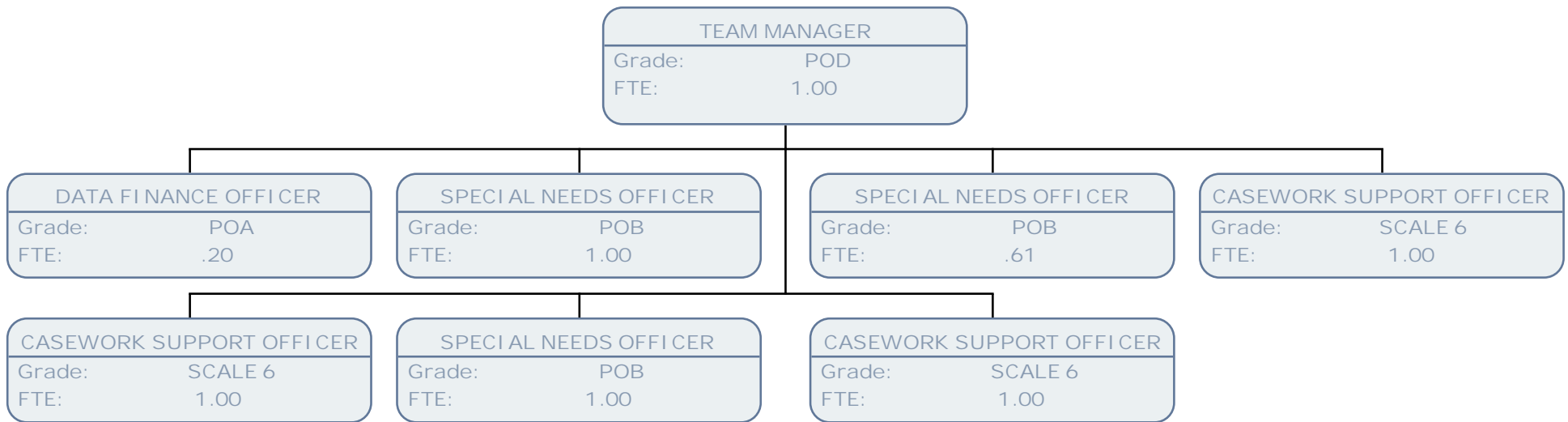

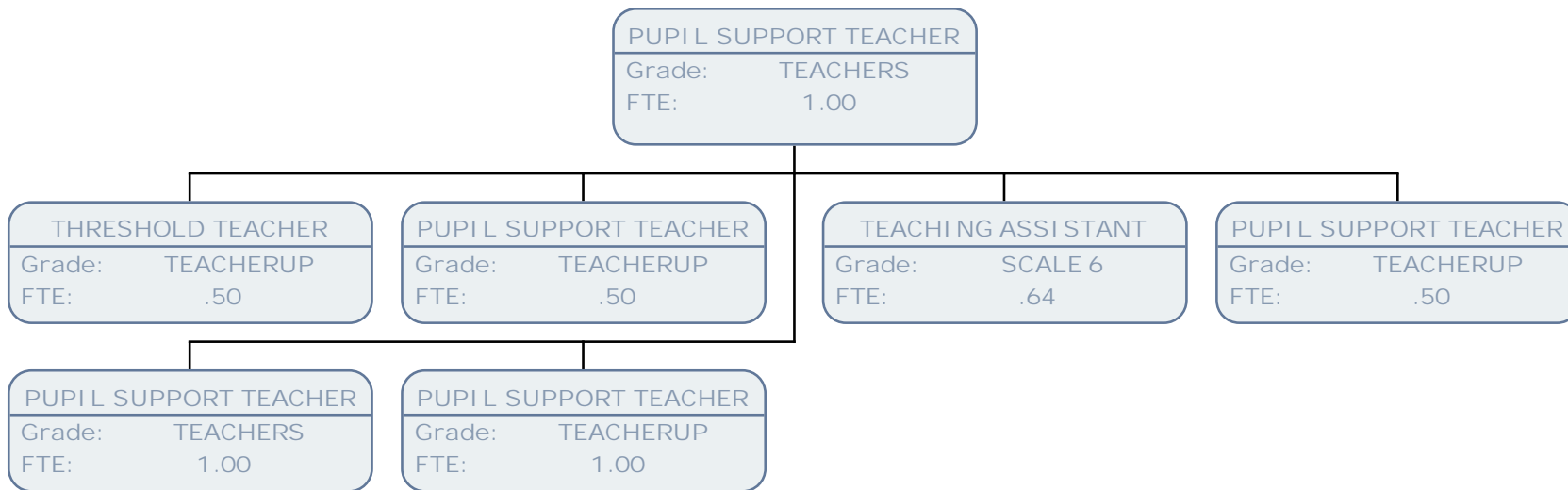

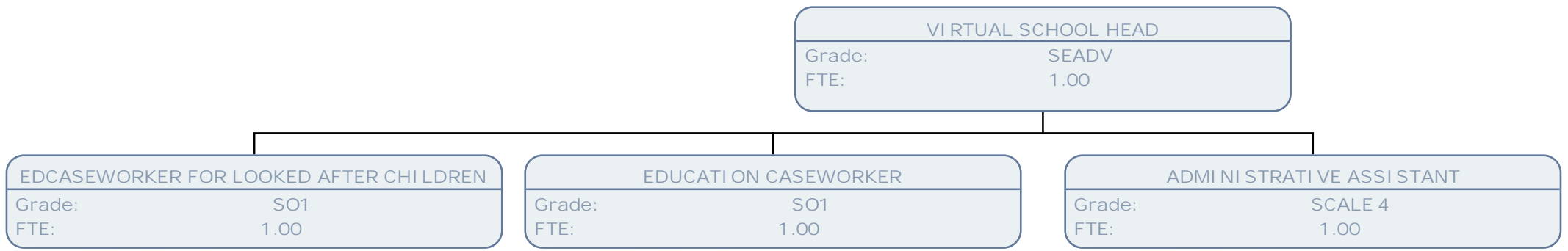

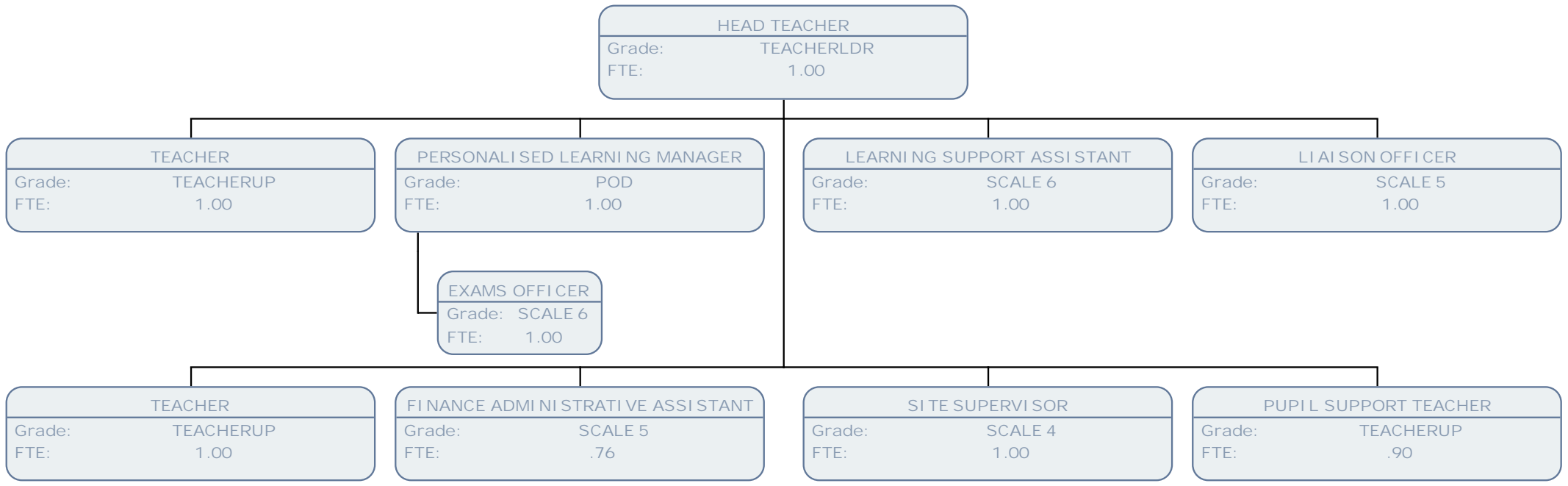

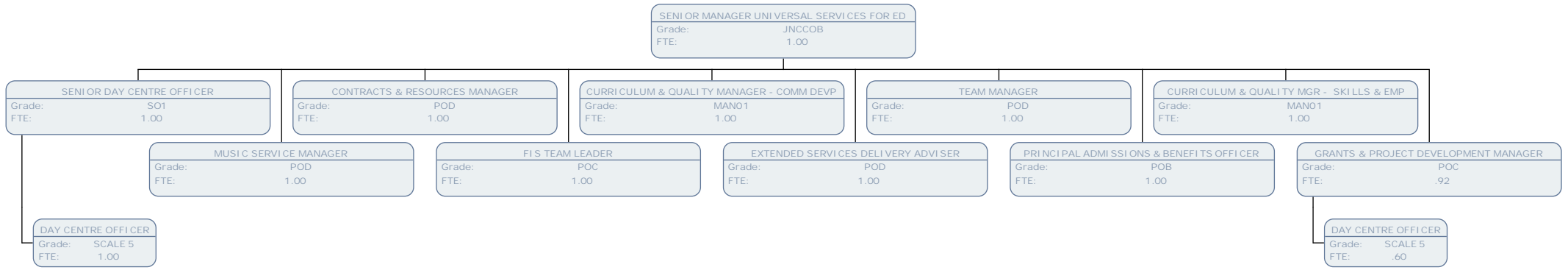

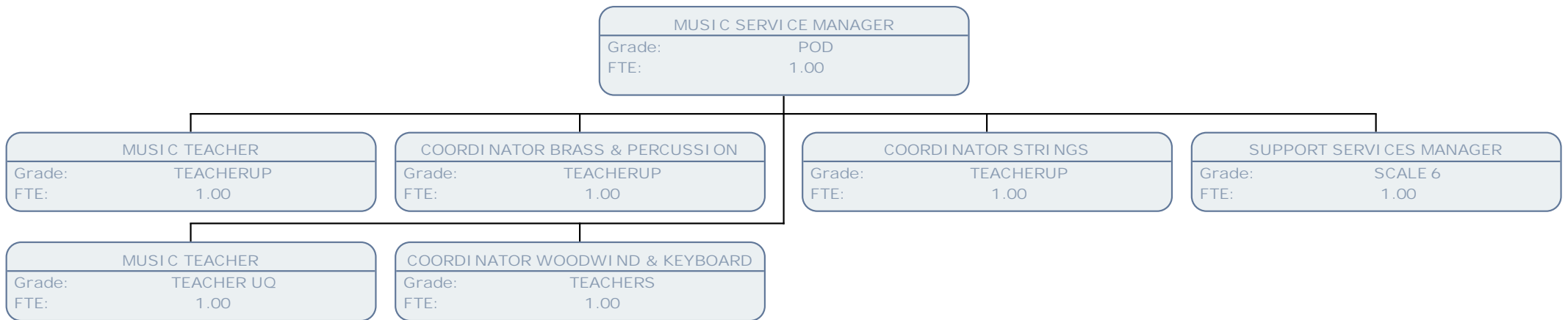

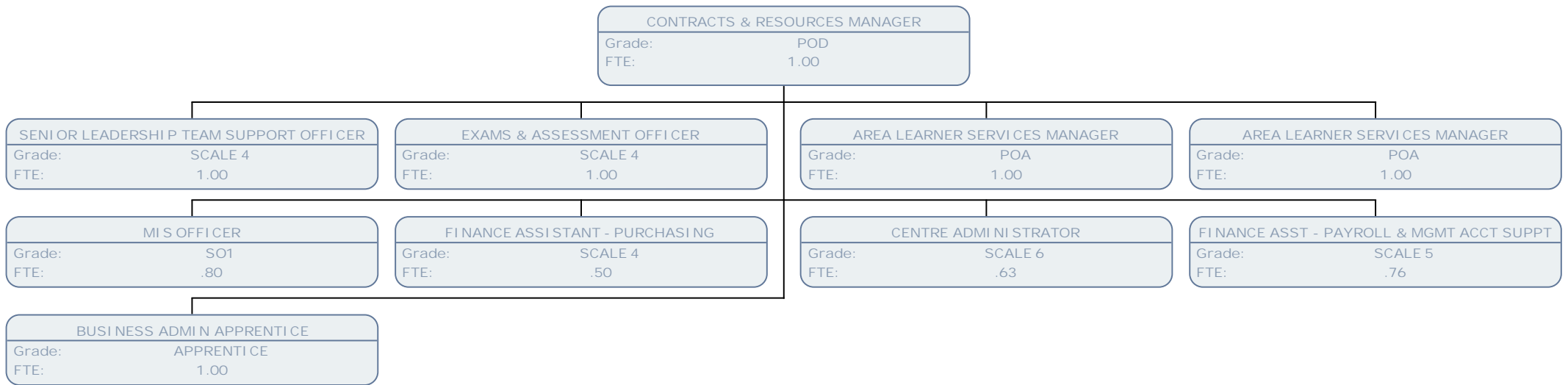

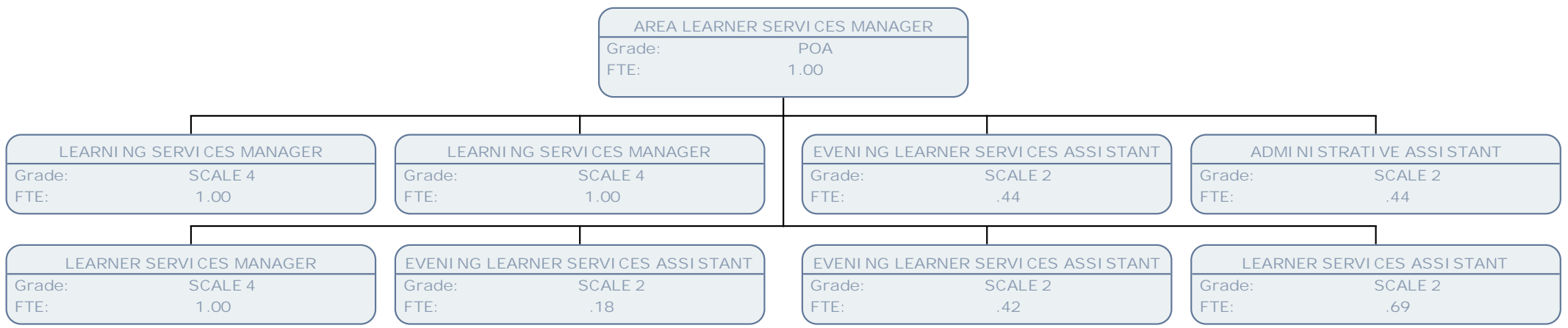

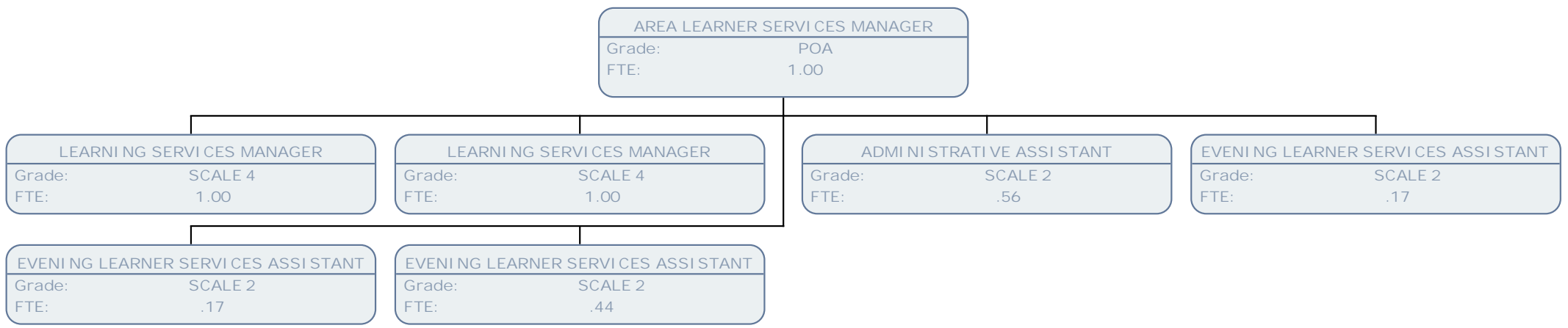

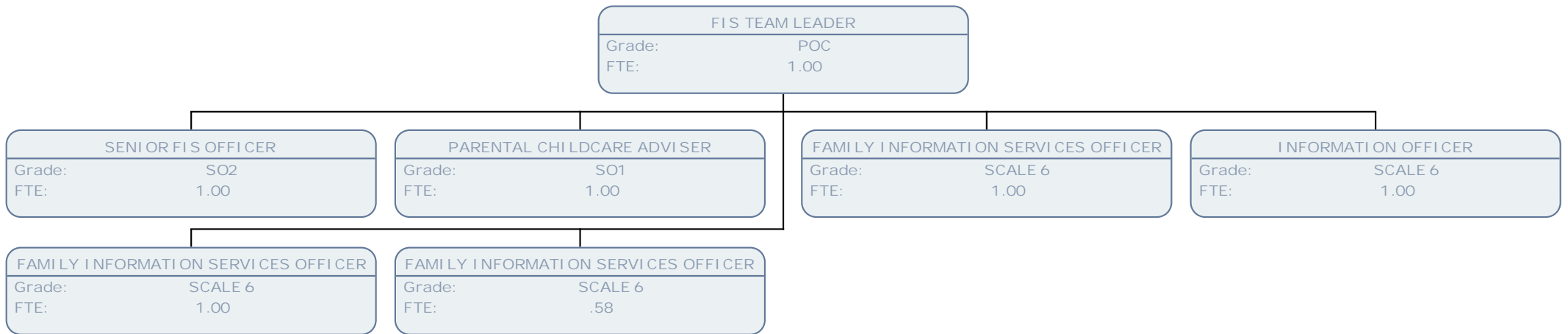

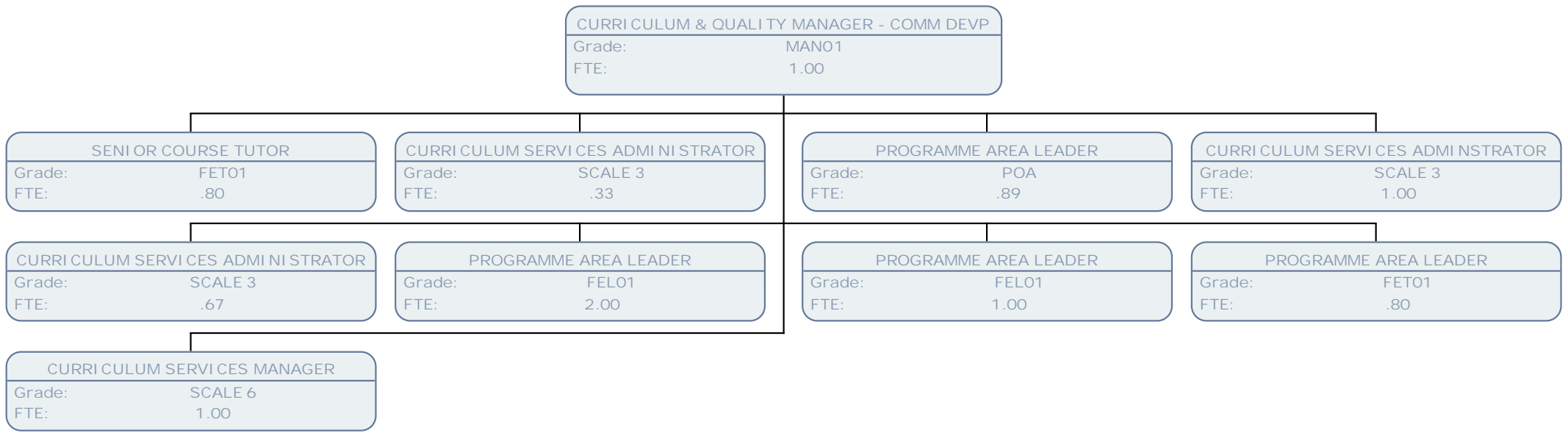

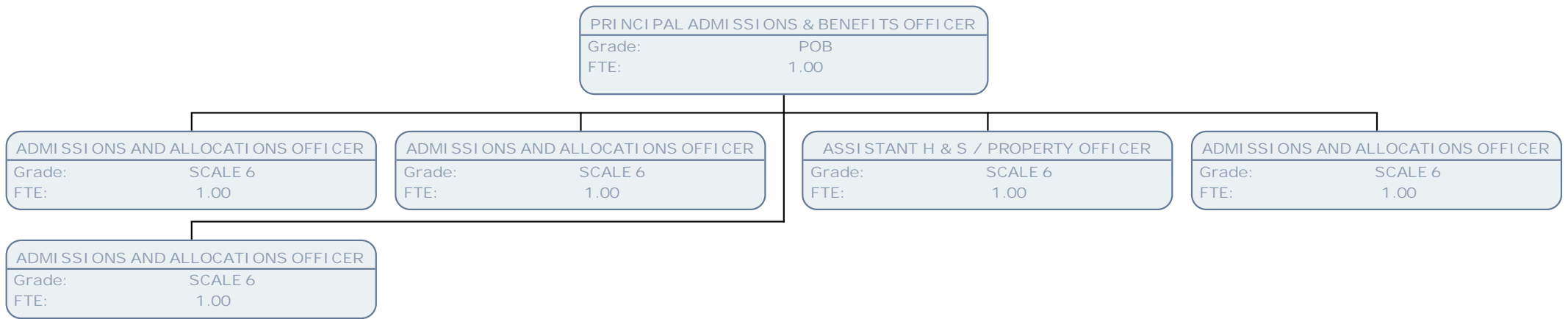

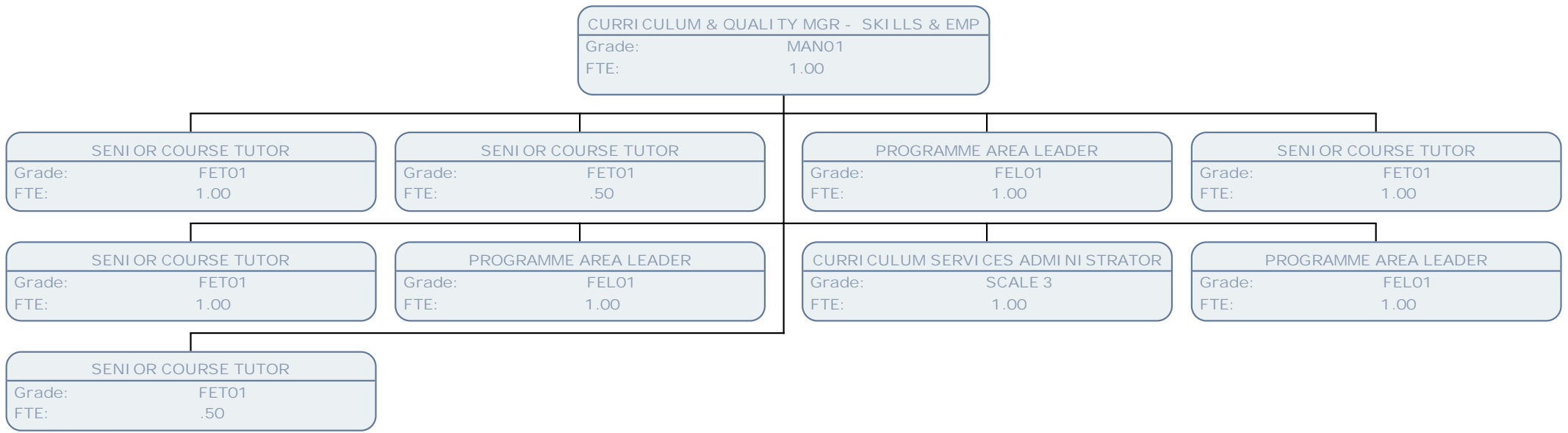

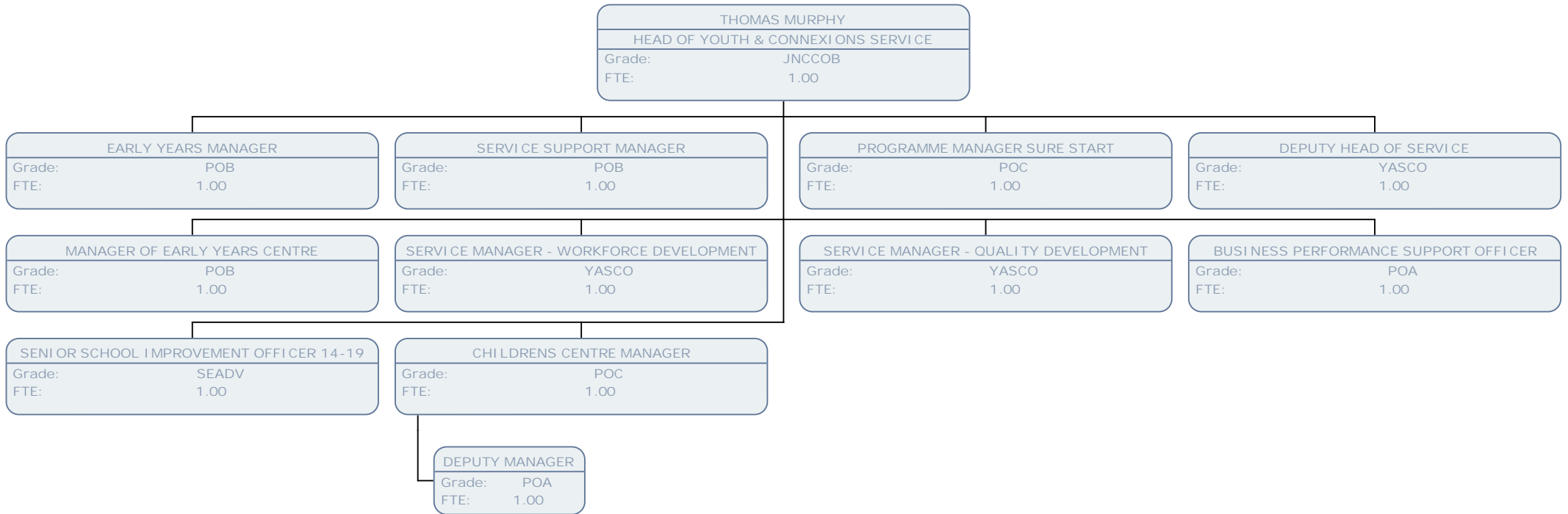

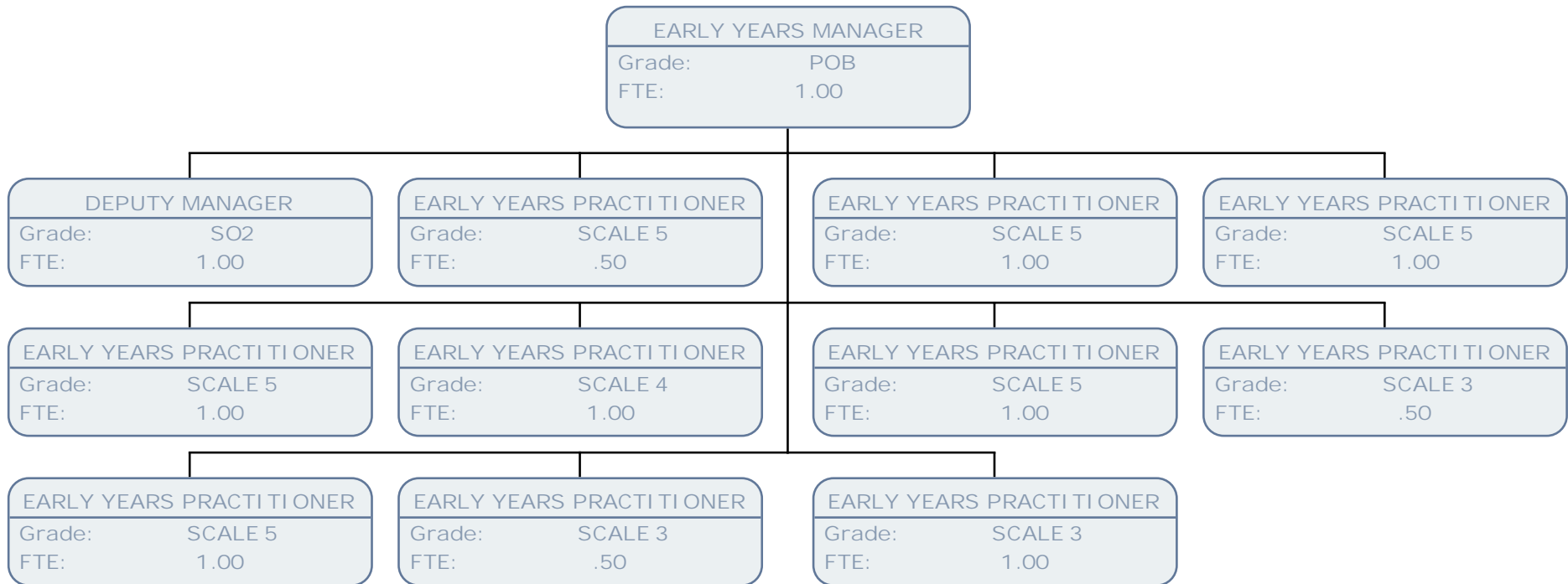

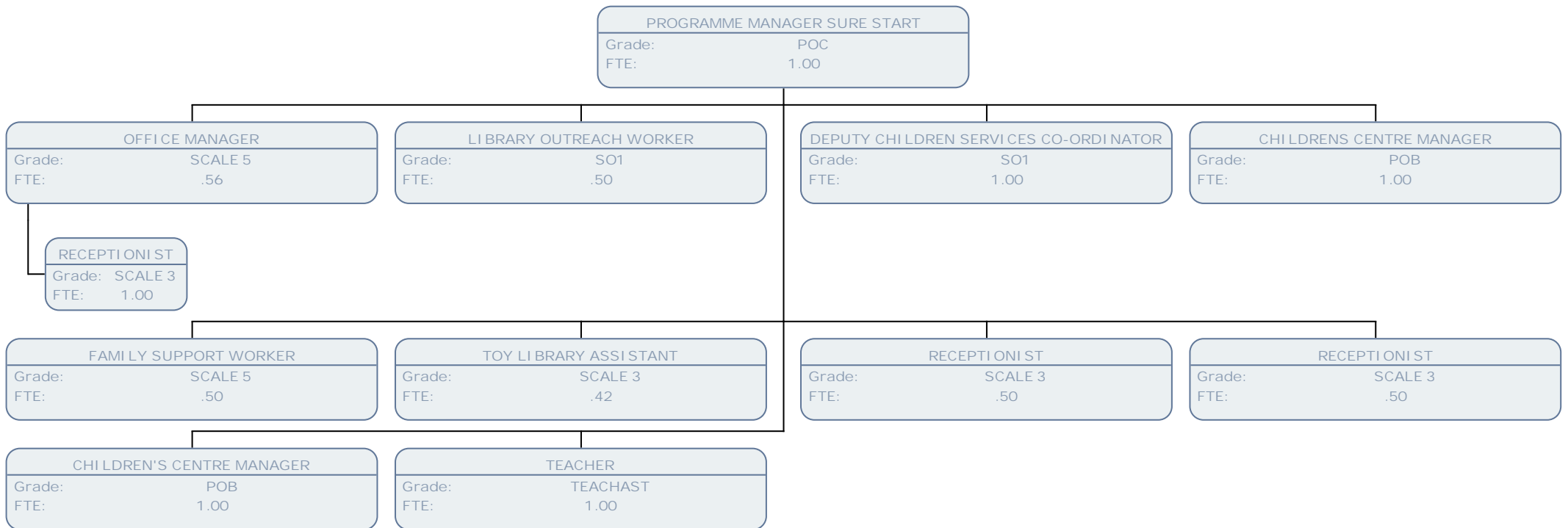

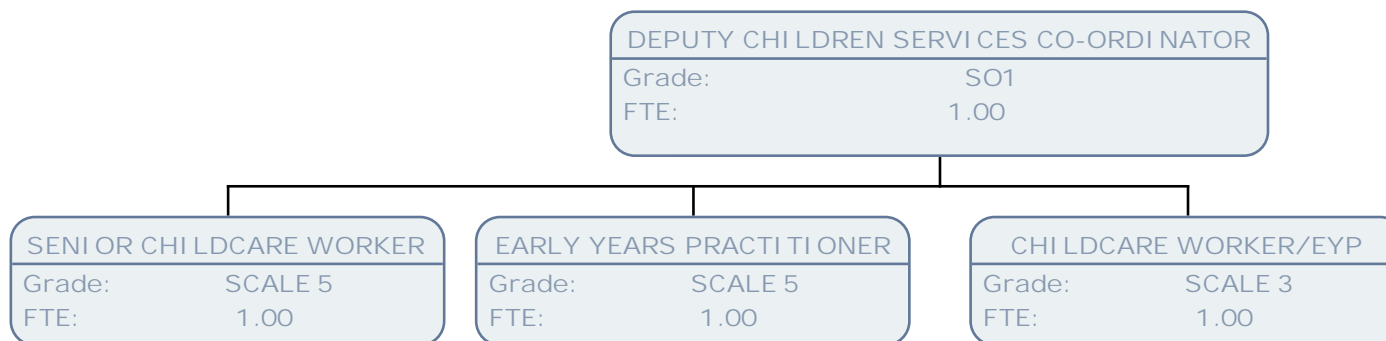

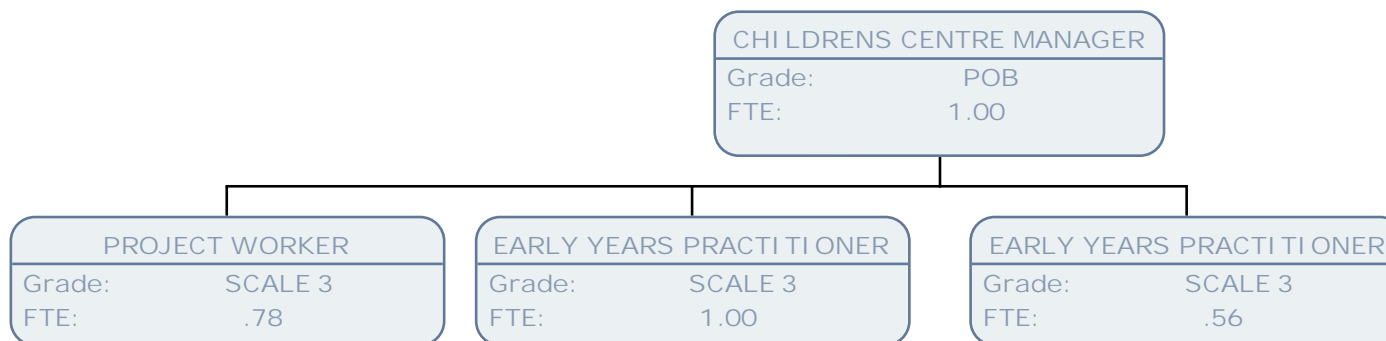

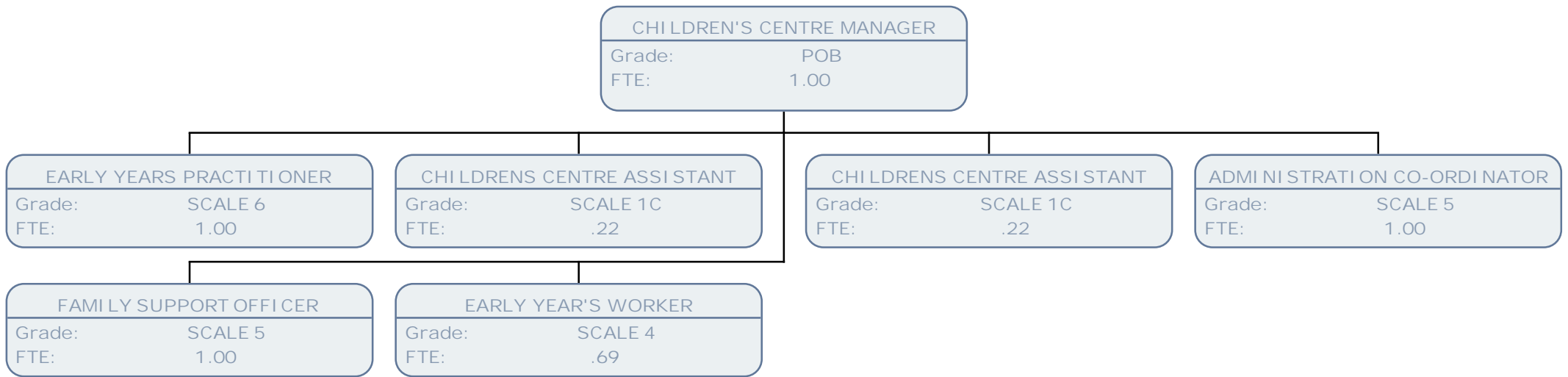

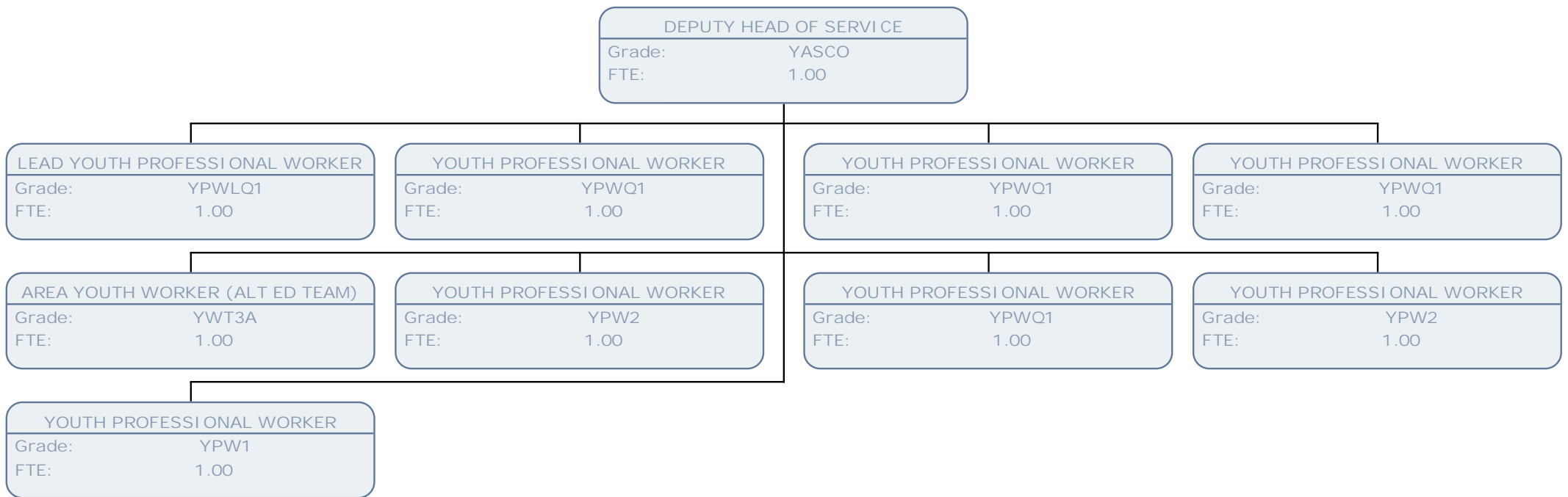

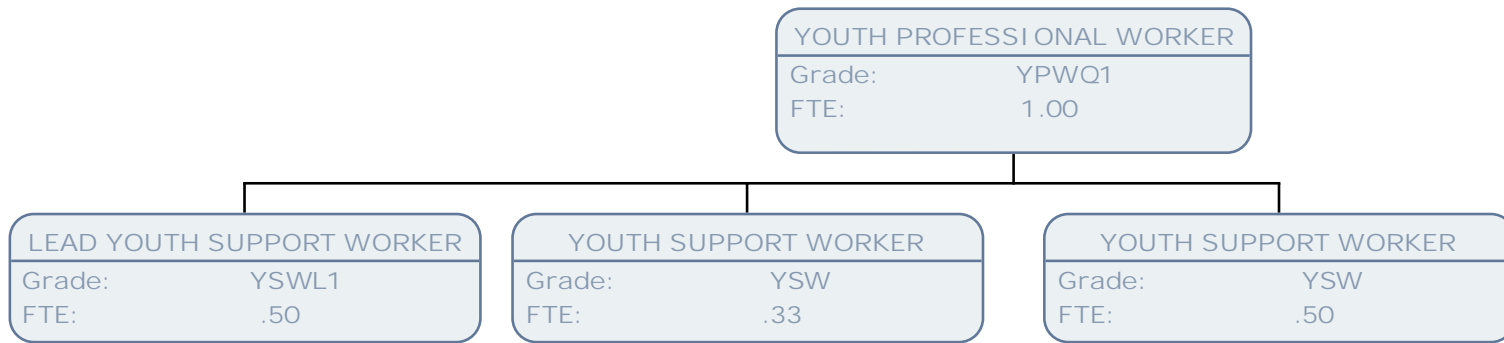

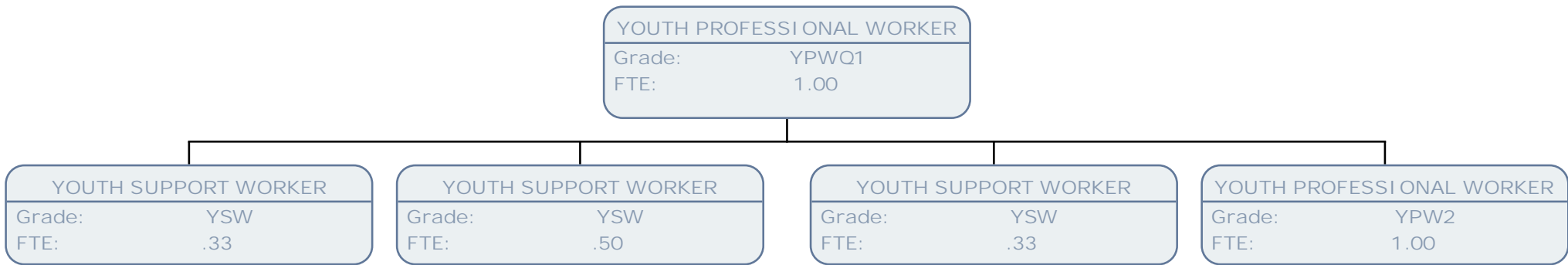

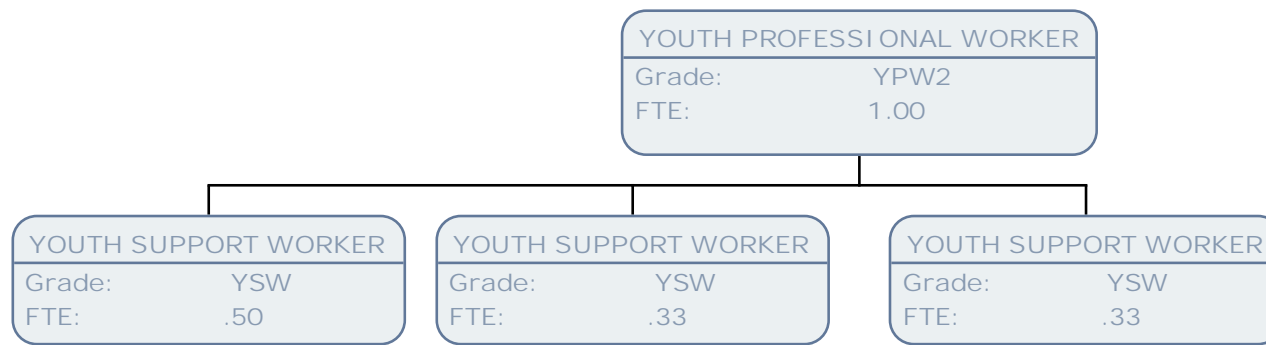

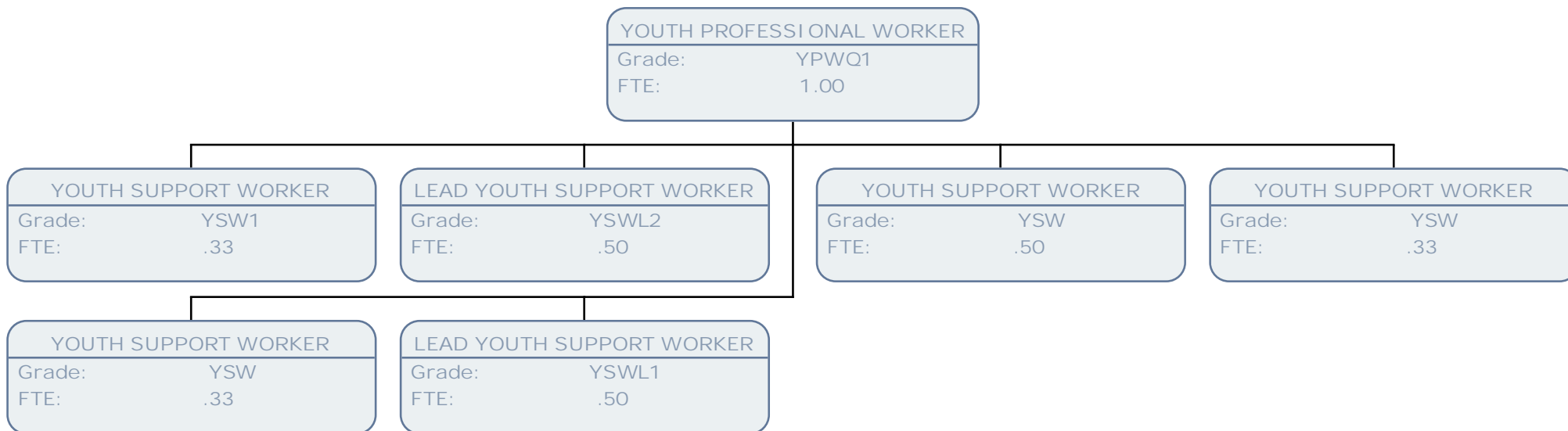

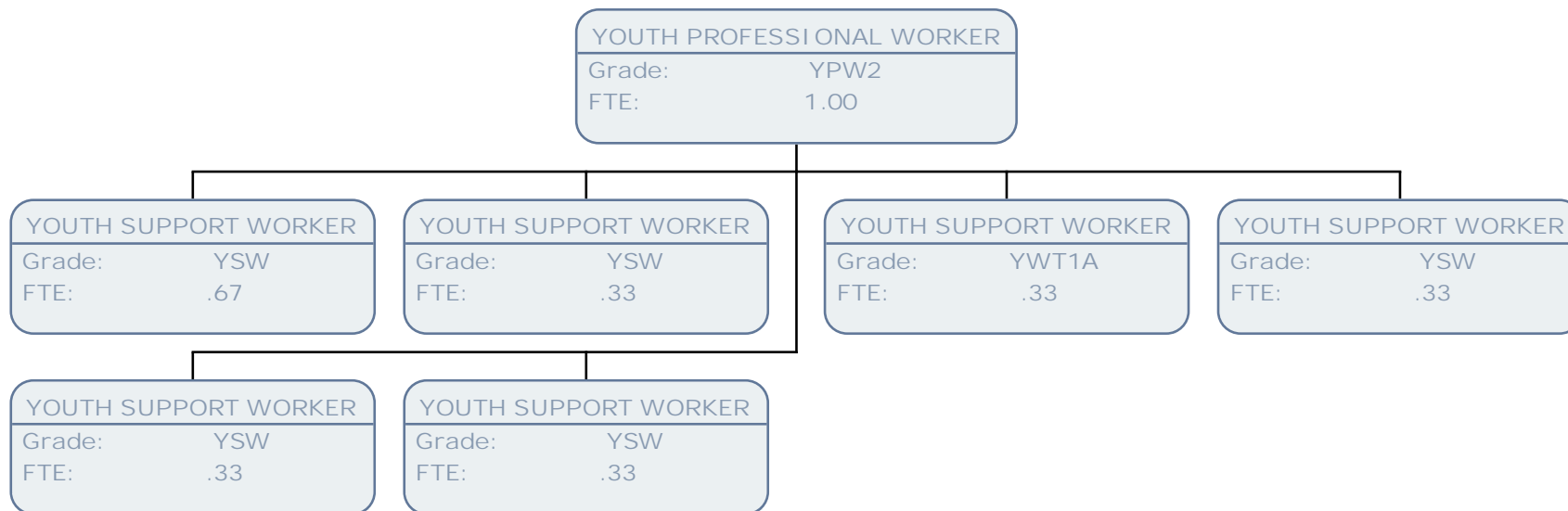

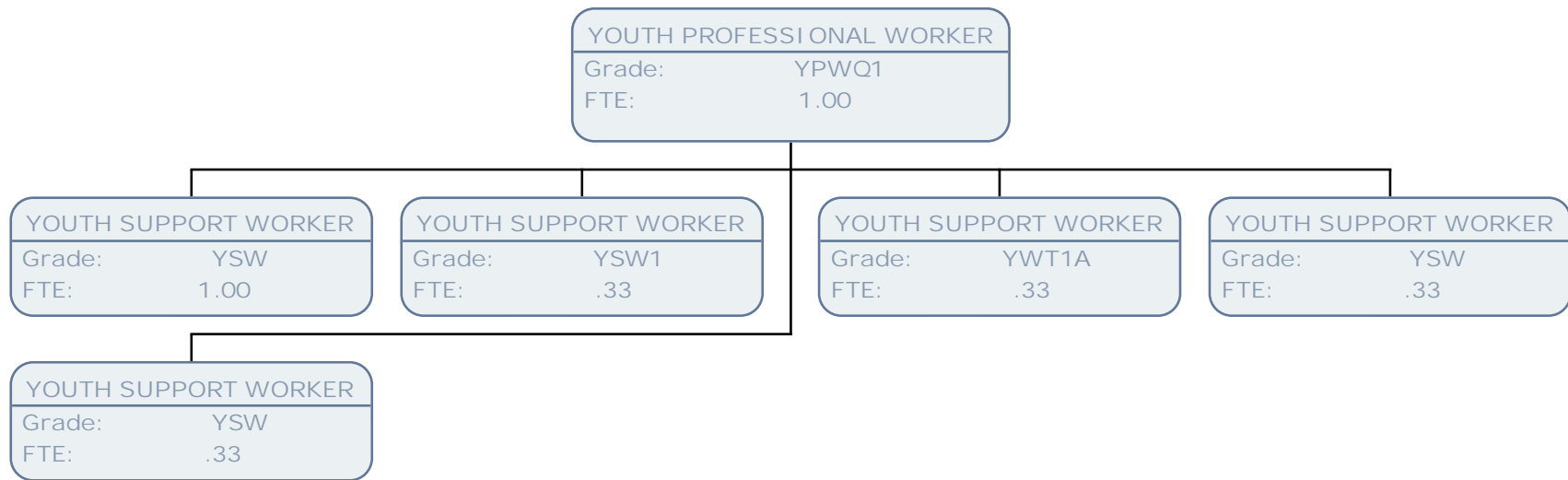

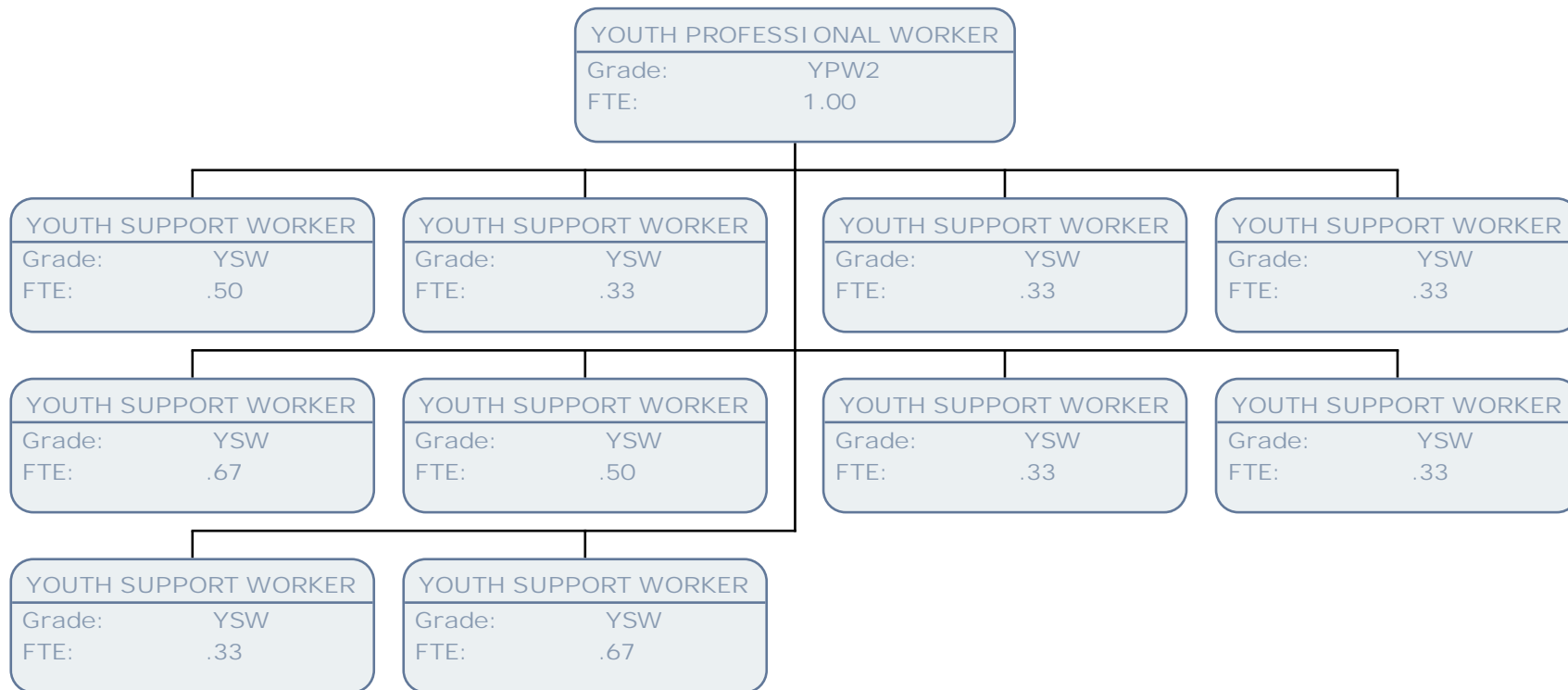

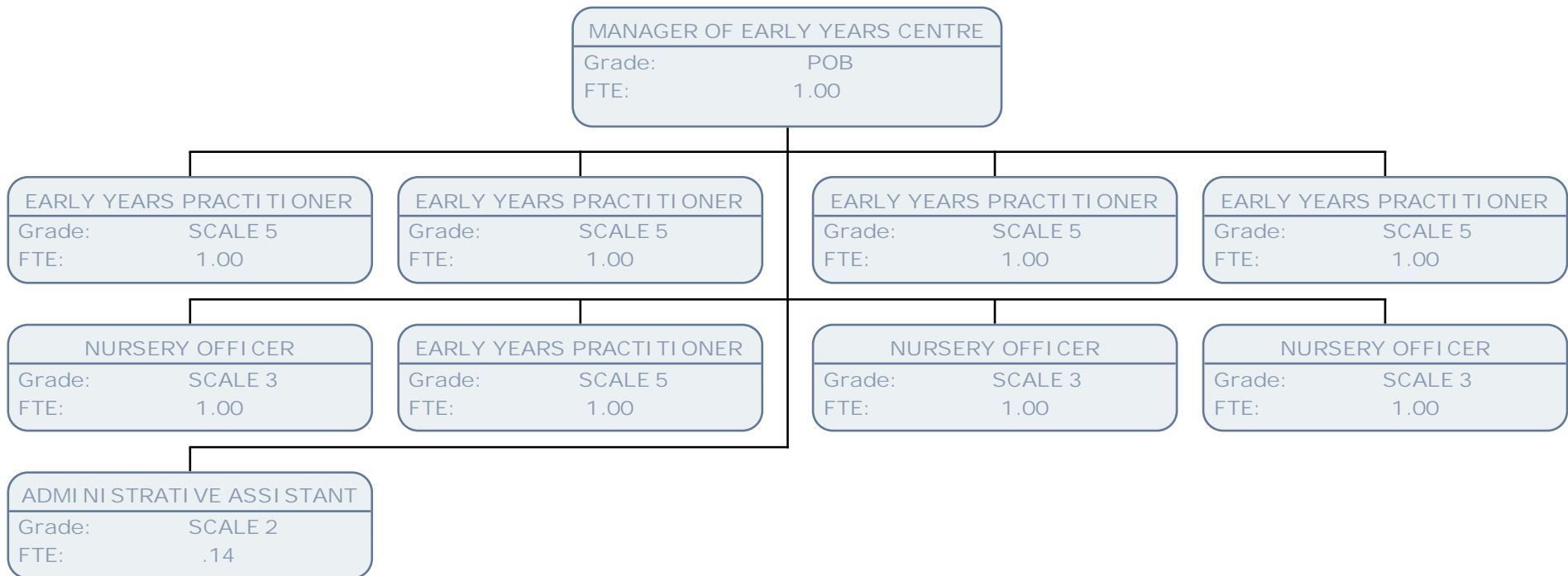

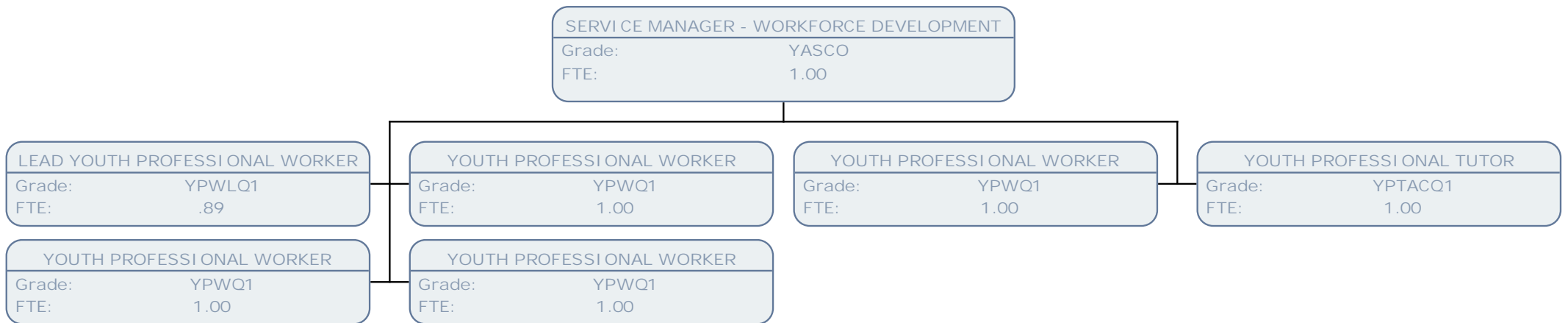

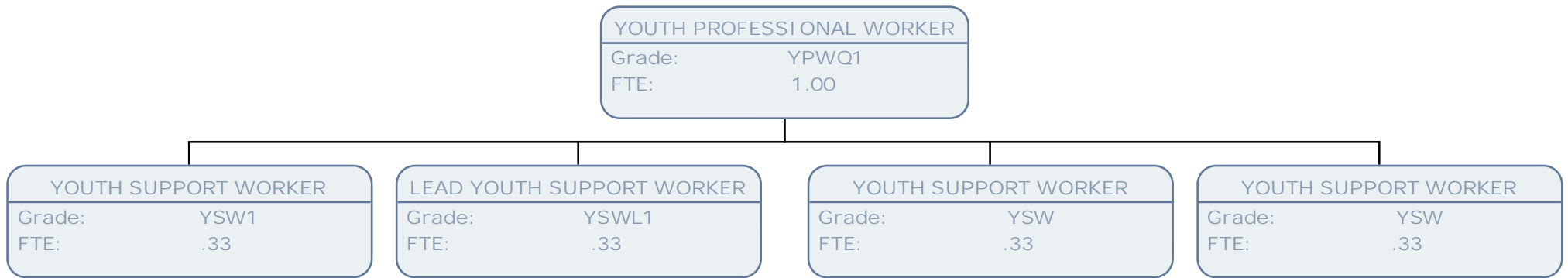

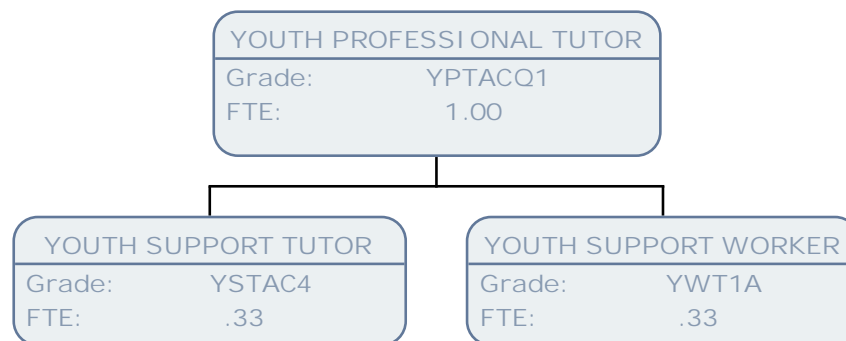

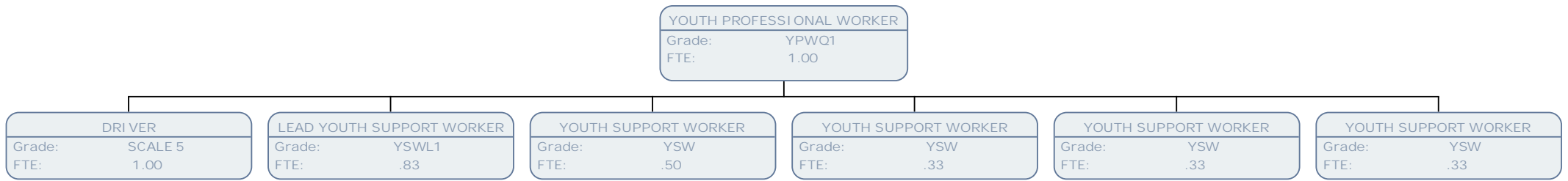

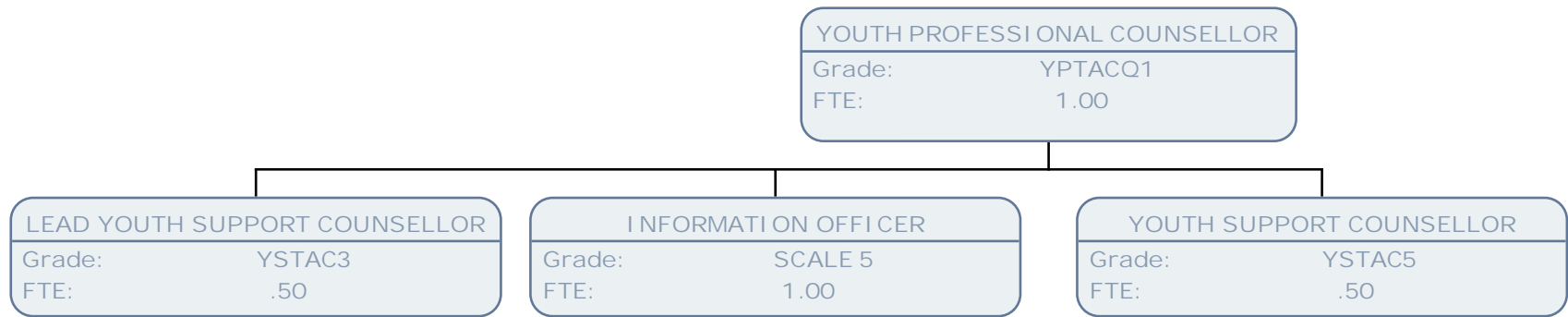

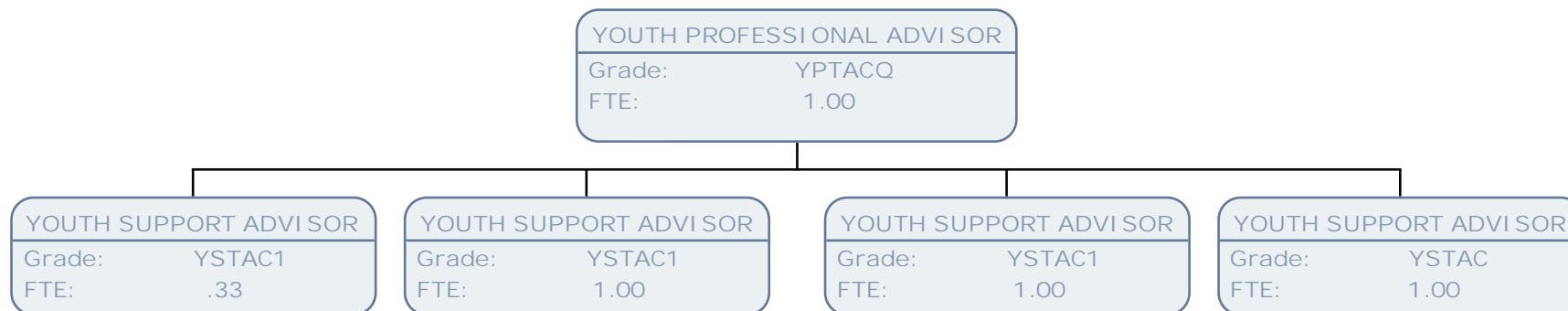

SENIOR SCHOOL IMPROVEMENT OFFICER 14-19	
Grade:	SEADV
FTE:	1.00

